

高精度、マイクロパワー、低ドロップアウト 大出力電流、SOT23電圧リファレンス

概要

MAX6061 ~ MAX6068は、低ドロップアウトマイクロパワー電圧リファレンスです。これらの3端子リファレンスは、1.25V、1.8V、2.048V、2.5V、3V、4.096V、4.5V及び5Vの出力電圧が用意されています。これらの製品は、マキシム社独自の曲率補正回路及びレーザートリミングの薄膜抵抗により、温度係数が20ppm/ (max)と低く、初期精度 $\pm 0.2\%$ (max)を実現しています。温度範囲は拡張温度範囲(-40 ~ +85) のものが用意されています。

MAX6061 ~ MAX6068は消費電流が僅か90 μ A(typ)で、負荷電流は5mAのソース、2mAのシンクが可能で、従来のシャントモード(2端子)リファレンスは電流を無駄に消費し、外付抵抗を必要とするのに対して、これらの素子は消費電流が殆ど電源電圧に影響されない(変動は8 μ A/V)他、外付抵抗を必要としません。さらに、これらの内部補償素子は、外部補償コンデンサを必要としません。外付補償コンデンサが排除されているため、スペースが厳しいアプリケーションにおいて貴重な基板面積を節約できます。低ドロップアウト電圧と電源に依存しない超低消費電流により、これらの素子はバッテリー駆動の高性能低電圧機器に最適となっています。

MAX6061 ~ MAX6068は超小型3ピンSOT23パッケージで提供されています。

アプリケーション

アナログデジタルコンバータ(ADC)
ポータブルバッテリー駆動機器
ノートブックコンピュータ
PDA、GPS、DMM
セルラ電話
高精度3V/5V機器

標準動作回路はデータシートの最後に記載されています。

選択ガイド

PART	OUTPUT VOLTAGE (V)	INPUT VOLTAGE (V)
MAX6061	1.248	2.5 to 12.6
MAX6068	1.800	2.5 to 12.6
MAX6062	2.048	2.5 to 12.6
MAX6066	2.500	($V_{OUT} + 200\text{mV}$) to 12.6
MAX6063	3.000	($V_{OUT} + 200\text{mV}$) to 12.6
MAX6064	4.096	($V_{OUT} + 200\text{mV}$) to 12.6
MAX6067	4.500	($V_{OUT} + 200\text{mV}$) to 12.6
MAX6065	5.000	($V_{OUT} + 200\text{mV}$) to 12.6

特長

- ◆ パッケージ：超小型3ピンSOT23
- ◆ 初期精度： $\pm 0.2\%$ (max)
- ◆ 温度係数：20ppm/
- ◆ ソース電流：5mA
- ◆ シンク電流：2mA
- ◆ 出力コンデンサが不要
- ◆ 容量性負荷で安定
- ◆ 自己消費電流：90 μ A(typ)
- ◆ ドロップアウト(負荷電流1mA)：200mV(max)
- ◆ 出力電圧オプション：1.25V、1.8V、2.048V、2.5V、3V、4.096V、4.5V、5V
- ◆ ノイズ：13 μ V_{P-P}(0.1Hz ~ 10Hz)(MAX6061)

型番

PART	TEMP. RANGE	PIN-PACKAGE	TOP MARK
MAX6061AEUR-T	-40°C to +85°C	3 SOT23-3	FZFP
MAX6061BEUR-T	-40°C to +85°C	3 SOT23-3	FZFQ
MAX6062AEUR-T	-40°C to +85°C	3 SOT23-3	FZFY
MAX6062BEUR-T	-40°C to +85°C	3 SOT23-3	FZFZ
MAX6063AEUR-T	-40°C to +85°C	3 SOT23-3	FZFV
MAX6063BEUR-T	-40°C to +85°C	3 SOT23-3	FZFW
MAX6064AEUR-T	-40°C to +85°C	3 SOT23-3	FZGB
MAX6064BEUR-T	-40°C to +85°C	3 SOT23-3	FZGC
MAX6065AEUR-T	-40°C to +85°C	3 SOT23-3	FZGE
MAX6065BEUR-T	-40°C to +85°C	3 SOT23-3	FZGF
MAX6066AEUR-T	-40°C to +85°C	3 SOT23-3	FZFM
MAX6066BEUR-T	-40°C to +85°C	3 SOT23-3	FZFN

Note: There is a minimum order increment of 2500 pieces for SOT23 packages.

Ordering Information continued at end of data sheet.

ピン配置

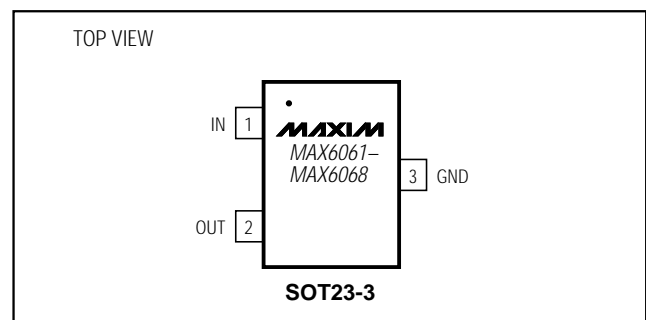

高精度、マイクロパワー、低ドロップアウト 大出力電流、SOT23電圧リファレンス

MAX6061-MAX6068

ABSOLUTE MAXIMUM RATINGS

(Voltages Referenced to GND)

IN	-0.3V to +13.5V
OUT	-0.3V to ($V_{IN} + 0.3V$)
Output Short-Circuit Duration to GND or IN ($V_{IN} < 6V$) ... Continuous	
Output Short-Circuit Duration to GND or IN ($V_{IN} \geq 6V$)	60s

Continuous Power Dissipation ($T_A = +70^\circ\text{C}$)

3-Pin SOT23 (derate 4.0mW/ $^\circ\text{C}$ above $+70^\circ\text{C}$)	320mW
Operating Temperature Range	-40°C to $+85^\circ\text{C}$
Storage Temperature Range	-65°C to $+150^\circ\text{C}$
Lead Temperature (soldering, 10s)	$+300^\circ\text{C}$

Stresses beyond those listed under "Absolute Maximum Ratings" may cause permanent damage to the device. These are stress ratings only, and functional operation of the device at these or any other conditions beyond those indicated in the operational sections of the specifications is not implied. Exposure to absolute maximum rating conditions for extended periods may affect device reliability.

ELECTRICAL CHARACTERISTICS—MAX6061, $V_{OUT} = 1.25V$

($V_{IN} = +5V$, $I_{OUT} = 0$, $T_A = T_{MIN}$ to T_{MAX} , unless otherwise noted. Typical values are at $T_A = +25^\circ\text{C}$.) (Note 1)

PARAMETER	SYMBOL	CONDITIONS	MIN	TYP	MAX	UNITS	
Output Voltage	V_{OUT}	$T_A = +25^\circ\text{C}$	MAX6061A (0.32%)	1.244	1.248	1.252	V
			MAX6061B (0.48%)	1.242	1.248	1.254	
Output Voltage Temperature Coefficient (Note 2)	TCV_{OUT}	MAX6061A		6	20	ppm/ $^\circ\text{C}$	
		MAX6061B		6	30		
Line Regulation	$\frac{\Delta V_{OUT}}{\Delta V_{IN}}$	$2.5V \leq V_{IN} \leq 12.6V$		10	90	$\mu\text{V/V}$	
Load Regulation	$\frac{\Delta V_{OUT}}{\Delta I_{OUT}}$	Sourcing: $0 \leq I_{OUT} \leq 5\text{mA}$		0.5	0.9	mV/mA	
		Sinking: $-2\text{mA} \leq I_{OUT} \leq 0$		1.3	3.0		
OUT Short-Circuit Current	I_{SC}	Short to GND		25		mA	
		Short to IN		25			
Long-Term Stability	$\frac{\Delta V_{OUT}}{\text{time}}$	1000hr at $+25^\circ\text{C}$		62		ppm/1000hr	
Output Voltage Hysteresis (Note 3)	$\frac{\Delta V_{OUT}}{\text{cycle}}$			130		ppm	
DYNAMIC CHARACTERISTICS							
Noise Voltage	e_{OUT}	$f = 0.1\text{Hz}$ to 10Hz		13		$\mu\text{Vp-p}$	
		$f = 10\text{Hz}$ to 10kHz		15		μVRMS	
Ripple Rejection	$\frac{\Delta V_{OUT}}{\Delta V_{IN}}$	$V_{IN} = 5V \pm 100\text{mV}$, $f = 120\text{Hz}$		86		dB	
Turn-On Settling Time	t_R	To $V_{OUT} = 0.1\%$ of final value, $C_{OUT} = 50\text{pF}$		50		μs	
INPUT CHARACTERISTICS							
Supply Voltage Range	V_{IN}	Guaranteed by line regulation test	2.5		12.6	V	
Quiescent Supply Current	I_{IN}			90	125	μA	
Change in Supply Current	$\frac{\Delta I_{IN}}{\Delta V_{IN}}$	$2.5V \leq V_{IN} \leq 12.6V$		3.4	8.0	$\mu\text{A/V}$	

高精度、マイクロパワー、低ドロップアウト 大出力電流、SOT23電圧リファレンス

MAX6061-MAX6068

ELECTRICAL CHARACTERISTICS—MAX6068, $V_{OUT} = 1.80V$

($V_{IN} = +5V$, $T_A = T_{MIN}$ to T_{MAX} , unless otherwise noted. Typical values are at $T_A = +25^\circ C$.) (Note 1)

PARAMETER	SYMBOL	CONDITIONS	MIN	TYP	MAX	UNITS	
Output Voltage	V_{OUT}	$T_A = +25^\circ C$	MAX6068A (0.17%)	1.797	1.800	1.803	V
			MAX6068B (0.39%)	1.793	1.800	1.807	
Output Voltage Temperature Coefficient (Note 2)	TCV_{OUT}	MAX6068A		6	20	ppm/ $^\circ C$	
		MAX6068B		6	30		
Line Regulation	$\frac{\Delta V_{OUT}}{\Delta V_{IN}}$	$2.5V \leq V_{IN} \leq 12.6V$		33	200	$\mu V/V$	
Load Regulation	$\frac{\Delta V_{OUT}}{\Delta I_{OUT}}$	Sourcing: $0 \leq I_{OUT} \leq 5mA$		0.5	0.9	mV/mA	
		Sinking: $-2mA \leq I_{OUT} \leq 0$		1.5	4		
OUT Short-Circuit Current	ISC	Short to GND		25		mA	
		Short to IN		25			
Long-Term Stability	$\frac{\Delta V_{OUT}}{\text{time}}$	1000hr at $+25^\circ C$		62		ppm/ 1000hr	
Output Voltage Hysteresis (Note 3)	$\frac{\Delta V_{OUT}}{\text{cycle}}$			130		ppm	
DYNAMIC CHARACTERISTICS							
Noise Voltage	e_{OUT}	$f = 0.1Hz$ to $10Hz$		22		μV_{p-p}	
		$f = 10Hz$ to $10kHz$		25		μV_{RMS}	
Ripple Rejection	$\frac{\Delta V_{OUT}}{\Delta V_{IN}}$	$V_{IN} = 5V \pm 100mV$, $f = 120Hz$		86		dB	
Turn-On Settling Time	t_R	To $V_{OUT} = 0.1\%$ of final value, $C_{OUT} = 50pF$		115		μs	
INPUT CHARACTERISTICS							
Supply Voltage Range	V_{IN}	Guaranteed by line regulation test	2.5		12.6	V	
Quiescent Supply Current	I_{IN}			90	125	μA	
Change in Supply Current	$\frac{\Delta I_{IN}}{\Delta V_{IN}}$	$2.5V \leq V_{IN} \leq 12.6V$		3.3	8.0	$\mu A/V$	

高精度、マイクロパワー、低ドロップアウト 大出力電流、SOT23電圧リファレンス

MAX6061-MAX6068

ELECTRICAL CHARACTERISTICS—MAX6062, $V_{OUT} = 2.048V$

($V_{IN} = +5V$, $I_{OUT} = 0$, $T_A = T_{MIN}$ to T_{MAX} , unless otherwise noted. Typical values are at $T_A = +25^{\circ}C$.) (Note 1)

PARAMETER	SYMBOL	CONDITIONS	MIN	TYP	MAX	UNITS	
Output Voltage	V_{OUT}	$T_A = +25^{\circ}C$	MAX6062A (0.24%)	2.043	2.048	2.053	V
			MAX6062B (0.39%)	2.040	2.048	2.056	
Output Voltage Temperature Coefficient (Note 2)	TCV_{OUT}	MAX6062A		6	20	ppm/ $^{\circ}C$	
		MAX6062B		6	30		
Line Regulation	$\Delta V_{OUT}/\Delta V_{IN}$	$2.5V \leq V_{IN} \leq 12.6V$		33	200	$\mu V/V$	
Load Regulation	$\Delta V_{OUT}/\Delta I_{OUT}$	Sourcing: $0 \leq I_{OUT} \leq 5mA$		0.5	0.9	mV/mA	
		Sinking: $-2mA \leq I_{OUT} \leq 0$		1.5	4		
OUT Short-Circuit Current	I_{SC}	Short to GND		25		mA	
		Short to IN		25			
Long-Term Stability	$\Delta V_{OUT}/$ time	1000hr at $+25^{\circ}C$		62		ppm/ 1000hr	
Output Voltage Hysteresis (Note 3)	$\Delta V_{OUT}/$ cycle			130		ppm	
DYNAMIC CHARACTERISTICS							
Noise Voltage	e_{OUT}	$f = 0.1Hz$ to $10Hz$		22		$\mu Vp-p$	
		$f = 10Hz$ to $10kHz$		25		μV_{RMS}	
Ripple Rejection	$\Delta V_{OUT}/\Delta V_{IN}$	$V_{IN} = 5V \pm 100mV$, $f = 120Hz$		86		dB	
Turn-On Settling Time	t_R	To $V_{OUT} = 0.1\%$ of final value, $C_{OUT} = 50pF$		115		μs	
INPUT CHARACTERISTICS							
Supply Voltage Range	V_{IN}	Guaranteed by line-regulation test	2.5		12.6	V	
Quiescent Supply Current	I_{IN}			90	125	μA	
Change in Supply Current	I_{IN}/V_{IN}	$2.5V \leq V_{IN} \leq 12.6V$		3.3	8.0	$\mu A/V$	

高精度、マイクロパワー、低ドロップアウト 大出力電流、SOT23電圧リファレンス

ELECTRICAL CHARACTERISTICS—MAX6066, V_{OUT} = 2.500V

(V_{IN} = +5V, I_{OUT} = 0, T_A = T_{MIN} to T_{MAX}, unless otherwise noted. Typical values are at T_A = +25°C.) (Note 1)

PARAMETER	SYMBOL	CONDITIONS	MIN	TYP	MAX	UNITS	
Output Voltage	V _{OUT}	T _A = +25°C	MAX6066A (0.2%)	2.495	2.500	2.505	V
			MAX6066B (0.4%)	2.490	2.500	2.510	
Output Voltage Temperature Coefficient (Note 2)	TCV _{OUT}	MAX6066A		6	20	ppm/°C	
		MAX6066B		6	30		
Line Regulation	$\frac{\Delta V_{OUT}}{\Delta V_{IN}}$	(V _{OUT} + 0.2V) ≤ V _{IN} ≤ 12.6V		60	300	μV/V	
Load Regulation	$\frac{\Delta V_{OUT}}{\Delta I_{OUT}}$	Sourcing: 0 ≤ I _{OUT} ≤ 5mA		0.5	0.9	mV/mA	
		Sinking: -2mA ≤ I _{OUT} ≤ 0		1.6	5		
Dropout Voltage (Note 4)	$V_{IN} - V_{OUT}$	I _{OUT} = 1mA		50	200	mV	
OUT Short-Circuit Current	I _{SC}	Short to GND		25		mA	
		Short to IN		25			
Long-Term Stability	$\frac{\Delta V_{OUT}}{\text{time}}$	1000hr at +25°C		62		ppm/1000hr	
Output Voltage Hysteresis (Note 3)	$\frac{\Delta V_{OUT}}{\text{cycle}}$			130		ppm	
DYNAMIC CHARACTERISTICS							
Noise Voltage	e _{OUT}	f = 0.1Hz to 10Hz		27		μVp-p	
		f = 10Hz to 10kHz		30		μV _{RMS}	
Ripple Rejection	$\frac{\Delta V_{OUT}}{\Delta V_{IN}}$	V _{IN} = 5V ± 100mV, f = 120Hz		86		dB	
Turn-On Settling Time	t _R	To V _{OUT} = 0.1% of final value, C _{OUT} = 50pF		115		μs	
INPUT CHARACTERISTICS							
Supply Voltage Range	V _{IN}	Guaranteed by line-regulation test		V _{OUT} + 0.2	12.6	V	
Quiescent Supply Current	I _{IN}			90	125	μA	
Change in Supply Current	I _{IN} /V _{IN}	(V _{OUT} + 0.2V) ≤ V _{IN} ≤ 12.6V		3.3	8.0	μA/V	

MAX60661-MAX60668

高精度、マイクロパワー、低ドロップアウト 大出力電流、SOT23電圧リファレンス

MAX6061-MAX6068

ELECTRICAL CHARACTERISTICS—MAX6063, $V_{OUT} = 3.0V$

($V_{IN} = +5V$, $I_{OUT} = 0$, $T_A = T_{MIN}$ to T_{MAX} , unless otherwise noted. Typical values are at $T_A = +25^\circ C$.) (Note 1)

PARAMETER	SYMBOL	CONDITIONS	MIN	TYP	MAX	UNITS	
Output Voltage	V_{OUT}	$T_A = +25^\circ C$	MAX6063A (0.2%)	2.994	3.000	3.006	V
			MAX6063B (0.4%)	2.988	3.000	3.012	
Output Voltage Temperature Coefficient (Note 2)	TCV_{OUT}	MAX6063A		6	20	ppm/ $^\circ C$	
		MAX6063B		6	30		
Line Regulation	$\frac{\Delta V_{OUT}}{\Delta V_{IN}}$	$(V_{OUT} + 0.2V) \leq V_{IN} \leq 12.6V$		90	400	$\mu V/V$	
Load Regulation	$\frac{\Delta V_{OUT}}{\Delta I_{OUT}}$	Sourcing: $0 \leq I_{OUT} \leq 5mA$		0.5	0.9	mV/mA	
		Sinking: $-2mA \leq I_{OUT} \leq 0$		2.0	6.0		
Dropout Voltage (Note 4)	$V_{IN} - V_{OUT}$	$I_{OUT} = 1mA$		50	200	mV	
OUT Short-Circuit Current	I_{SC}	Short to GND		25		mA	
		Short to IN		25			
Long-Term Stability	$\frac{\Delta V_{OUT}}{\text{time}}$	1000hr at $+25^\circ C$		62		ppm/ 1000hr	
Output Voltage Hysteresis (Note 3)	$\frac{\Delta V_{OUT}}{\text{cycle}}$			130		ppm	
DYNAMIC CHARACTERISTICS							
Noise Voltage	e_{OUT}	$f = 0.1Hz$ to $10Hz$		35		$\mu Vp-p$	
		$f = 10Hz$ to $10kHz$		40		μV_{RMS}	
Ripple Rejection	$\frac{\Delta V_{OUT}}{\Delta V_{IN}}$	$V_{IN} = 5V \pm 100mV$, $f = 120Hz$		76		dB	
Turn-On Settling Time	t_R	To $V_{OUT} = 0.1\%$ of final value, $C_{OUT} = 50pF$		115		μs	
INPUT CHARACTERISTICS							
Supply Voltage Range	V_{IN}	Guaranteed by line-regulation test		$V_{OUT} + 0.2$	12.6	V	
Quiescent Supply Current	I_{IN}			90	125	μA	
Change in Supply Current	I_{IN}/V_{IN}	$(V_{OUT} + 0.2V) \leq V_{IN} \leq 12.6V$		3.4	8.0	$\mu A/V$	

高精度、マイクロパワー、低ドロップアウト 大出力電流、SOT23電圧リファレンス

MAX6061-MAX6068

ELECTRICAL CHARACTERISTICS—MAX6064, $V_{OUT} = 4.096V$

($V_{IN} = +5V$, $I_{OUT} = 0$, $T_A = T_{MIN}$ to T_{MAX} , unless otherwise noted. Typical values are at $T_A = +25^{\circ}C$.) (Note 1)

PARAMETER	SYMBOL	CONDITIONS	MIN	TYP	MAX	UNITS	
Output Voltage	V_{OUT}	$T_A = +25^{\circ}C$	MAX6064A (0.2%)	4.088	4.096	4.104	V
			MAX6064B (0.4%)	4.080	4.096	4.112	
Output Voltage Temperature Coefficient (Note 2)	TCV_{OUT}	MAX6064A		6	20	ppm/ $^{\circ}C$	
		MAX6064B		6	30		
Line Regulation	$\frac{\Delta V_{OUT}}{\Delta V_{IN}}$	$(V_{OUT} + 0.2V) \leq V_{IN} \leq 12.6V$		130	430	$\mu V/V$	
Load Regulation	$\frac{\Delta V_{OUT}}{\Delta I_{OUT}}$	Sourcing: $0 \leq I_{OUT} \leq 5mA$		0.5	0.9	mV/mA	
		Sinking: $-2mA \leq I_{OUT} \leq 0$		2.2	8		
Dropout Voltage (Note 4)	$V_{IN} - V_{OUT}$	$I_{OUT} = 1mA$		50	200	mV	
OUT Short-Circuit Current	I_{SC}	Short to GND		25		mA	
		Short to IN		25			
Long-Term Stability	$\frac{\Delta V_{OUT}}{\text{time}}$	1000hr at $+25^{\circ}C$		62		ppm/1000hr	
Output Voltage Hysteresis (Note 3)	$\frac{\Delta V_{OUT}}{\text{cycle}}$			130		ppm	
DYNAMIC CHARACTERISTICS							
Noise Voltage	e_{OUT}	$f = 0.1Hz$ to $10Hz$		50		μV_{p-p}	
		$f = 10Hz$ to $10kHz$		50		μV_{RMS}	
Ripple Rejection	$\frac{\Delta V_{OUT}}{\Delta V_{IN}}$	$V_{IN} = 5V \pm 100mV$, $f = 120Hz$		72		dB	
Turn-On Settling Time	t_R	To $V_{OUT} = 0.1\%$ of final value, $C_{OUT} = 50pF$		190		μs	
INPUT CHARACTERISTICS							
Supply Voltage Range	V_{IN}	Guaranteed by line-regulation test		$V_{OUT} + 0.2$	12.6	V	
Quiescent Supply Current	I_{IN}			90	125	μA	
Change in Supply Current	I_{IN}/V_{IN}	$(V_{OUT} + 0.2V) \leq V_{IN} \leq 12.6V$		3.2	8.0	$\mu A/V$	

高精度、マイクロパワー、低ドロップアウト 大出力電流、SOT23電圧リファレンス

MAX6067-MAX6068

ELECTRICAL CHARACTERISTICS—MAX6067, $V_{OUT} = 4.500V$

($V_{IN} = +5V$, $I_{OUT} = 0$, $T_A = T_{MIN}$ to T_{MAX} , unless otherwise noted. Typical values are at $T_A = +25^{\circ}C$.) (Note 1)

PARAMETER	SYMBOL	CONDITIONS	MIN	TYP	MAX	UNITS	
Output Voltage	V_{OUT}	$T_A = +25^{\circ}C$	MAX6067A (0.2%)	4.491	4.500	4.509	V
			MAX6067B (0.4%)	4.482	4.500	4.518	
Output Voltage Temperature Coefficient (Note 2)	TCV_{OUT}	MAX6067A		6	20	ppm/ $^{\circ}C$	
		MAX6067B		6	30		
Line Regulation	$\frac{\Delta V_{OUT}}{\Delta V_{IN}}$	$(V_{OUT} + 0.2V) \leq V_{IN} \leq 12.6V$		170	550	$\mu V/V$	
Load Regulation	$\frac{\Delta V_{OUT}}{\Delta I_{OUT}}$	Sourcing: $0 \leq I_{OUT} \leq 5mA$		0.5	0.9	mV/mA	
		Sinking: $-2mA \leq I_{OUT} \leq 0$		2.4	8		
Dropout Voltage (Note 4)	$V_{IN} - V_{OUT}$	$I_{OUT} = 1mA$		50	200	mV	
OUT Short-Circuit Current	I_{SC}	Short to GND		25		mA	
		Short to IN		25			
Long-Term Stability	$\frac{\Delta V_{OUT}}{\text{time}}$	1000hr at $+25^{\circ}C$		62		ppm/1000hr	
Output Voltage Hysteresis (Note 3)	$\frac{\Delta V_{OUT}}{\text{cycle}}$			130		ppm	
DYNAMIC CHARACTERISTICS							
Noise Voltage	e_{OUT}	$f = 0.1Hz$ to $10Hz$		55		$\mu Vp-p$	
		$f = 10Hz$ to $10kHz$		55		μV_{RMS}	
Ripple Rejection	$\frac{\Delta V_{OUT}}{\Delta V_{IN}}$	$V_{IN} = 5V \pm 100mV$, $f = 120Hz$		70		dB	
Turn-On Settling Time	t_R	To $V_{OUT} = 0.1\%$ of final value, $C_{OUT} = 50pF$		230		μs	
INPUT CHARACTERISTICS							
Supply Voltage Range	V_{IN}	Guaranteed by line-regulation test		$V_{OUT} + 0.2$	12.6	V	
Quiescent Supply Current	I_{IN}			90	125	μA	
Change in Supply Current	I_{IN}/V_{IN}	$(V_{OUT} + 0.2V) \leq V_{IN} \leq 12.6V$		3.2	8.0	$\mu A/V$	

高精度、マイクロパワー、低ドロップアウト 大出力電流、SOT23電圧リファレンス

MAX6061-MAX6068

ELECTRICAL CHARACTERISTICS—MAX6065, V_{OUT} = 5.000V

(V_{IN} = +5.2V, I_{OUT} = 0, T_A = T_{MIN} to T_{MAX}, unless otherwise noted. Typical values are at T_A = +25°C.) (Note 1)

PARAMETER	SYMBOL	CONDITIONS	MIN	TYP	MAX	UNITS	
Output Voltage	V _{OUT}	T _A = +25°C	MAX6065A (0.2%)	4.990	5.000	5.010	V
			MAX6065B (0.4%)	4.980	5.000	5.020	
Output Voltage Temperature Coefficient (Note 2)	TC _{VOUT}	MAX6065A		6	20	ppm/°C	
		MAX6065B		6	30		
Line Regulation	$\frac{\Delta V_{OUT}}{\Delta V_{IN}}$	(V _{OUT} + 0.2V) ≤ V _{IN} ≤ 12.6V		180	550	μV/V	
Load Regulation	$\frac{\Delta V_{OUT}}{\Delta I_{OUT}}$	Sourcing: 0 ≤ I _{OUT} ≤ 5mA		0.5	0.9	mV/mA	
		Sinking: -2mA ≤ I _{OUT} ≤ 0		2.4	8.0		
Dropout Voltage (Note 4)	$V_{IN} - V_{OUT}$	I _{OUT} = 1mA		50	200	mV	
OUT Short-Circuit Current	I _{SC}	Short to GND		25		mA	
		Short to IN		25			
Long-Term Stability	$\frac{\Delta V_{OUT}}{\text{time}}$	1000hr at +25°C		62		ppm/ 1000hr	
Output Voltage Hysteresis (Note 3)	$\frac{\Delta V_{OUT}}{\text{cycle}}$			130		ppm	
DYNAMIC CHARACTERISTICS							
Noise Voltage	e _{OUT}	f = 0.1Hz to 10Hz		60		μVp-p	
		f = 10Hz to 10kHz		60		μV _{RMS}	
Ripple Rejection	$\frac{\Delta V_{OUT}}{\Delta V_{IN}}$	V _{IN} = 5V ±100mV, f = 120Hz		65		dB	
Turn-On Settling Time	t _R	To V _{OUT} = 0.1% of final value, C _{OUT} = 50pF		300		μs	
INPUT CHARACTERISTICS							
Supply Voltage Range	V _{IN}	Guaranteed by line-regulation test		V _{OUT} + 0.2	12.6	V	
Quiescent Supply Current	I _{IN}			90	125	μA	
Change in Supply Current	I _{IN} /V _{IN}	(V _{OUT} + 0.2V) ≤ V _{IN} ≤ 12.6V		3.2	8.0	μA/V	

Note 1: All devices are 100% production tested at T_A = +25°C and are guaranteed by design for T_A = T_{MIN} to T_{MAX}, as specified.

Note 2: Temperature Coefficient is measured by the "box" method, i.e., the maximum ΔV_{OUT} is divided by the maximum ΔT.

Note 3: Temperature Hysteresis is defined as the change in +25°C output voltage before and after cycling the device from T_{MIN} to T_{MAX}.

Note 4: Dropout voltage is the minimum input voltage at which V_{OUT} changes ≤ 0.2% from V_{OUT} at V_{IN} = 5.0V (V_{IN} = 5.5V for MAX6065).

高精度、マイクロパワー、低ドロップアウト 大出力電流、SOT23電圧リファレンス

MAX6061-MAX6068

標準動作特性

($V_{IN} = +5V$ for MAX6061-MAX6068, $V_{IN} = +5.5V$ for MAX6065, $I_{OUT} = 0$, $T_A = +25^\circ C$, unless otherwise noted.) (Note 5)

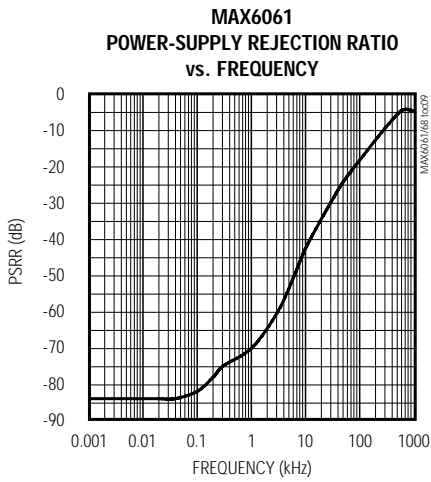
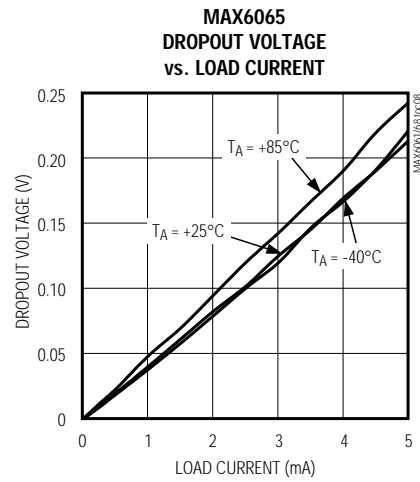
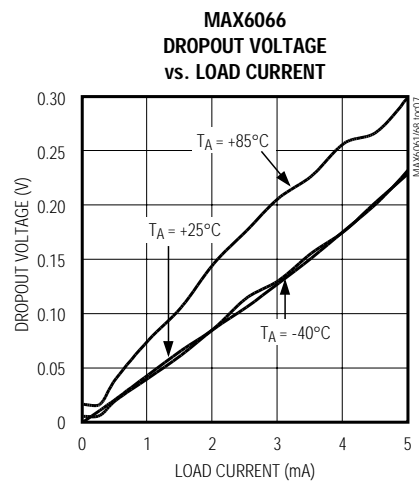
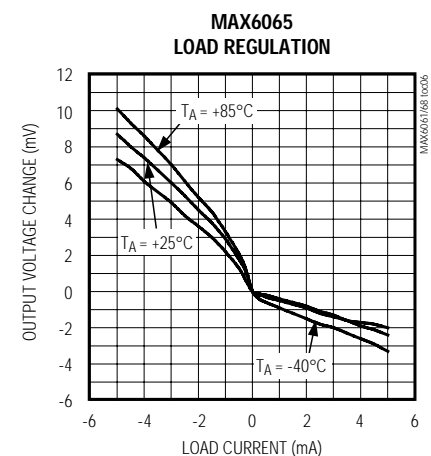
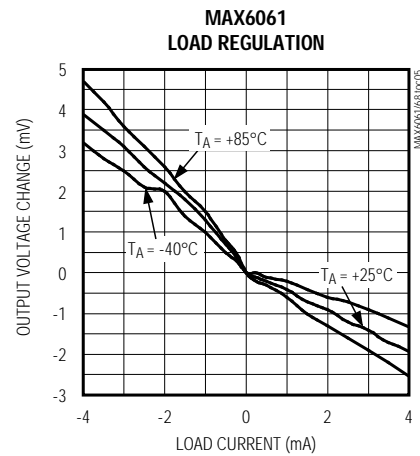
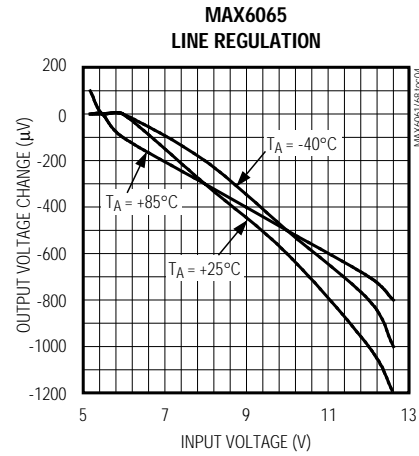
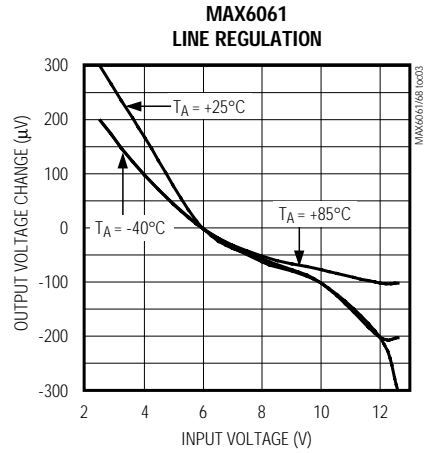
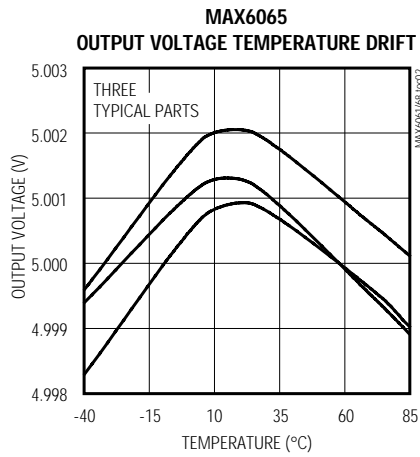
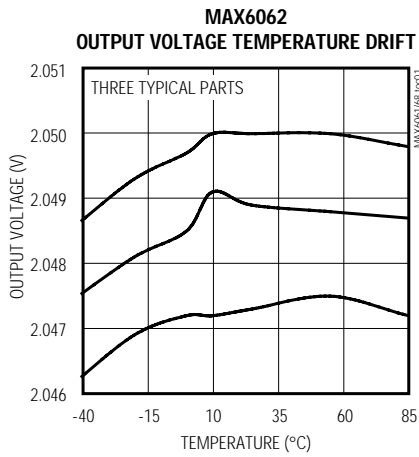

高精度、マイクロパワー、低ドロップアウト 大出力電流、SOT23電圧リファレンス

MAX6061-MAX6068

標準動作特性(続き)

($V_{IN} = +5V$ for MAX6061-MAX6068, $V_{IN} = +5.5V$ for MAX6065, $I_{OUT} = 0$, $T_A = +25^\circ C$, unless otherwise noted.) (Note 5)

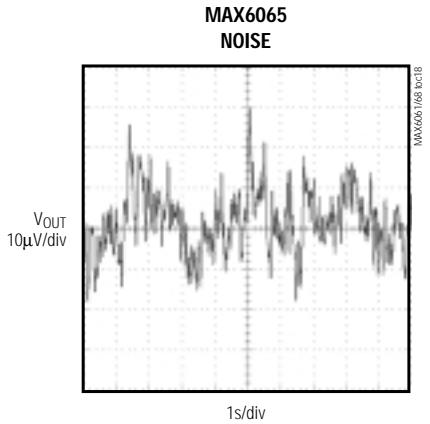
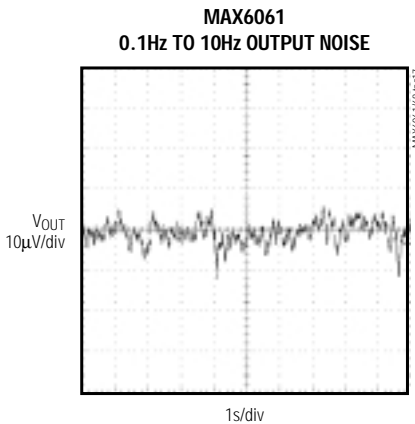
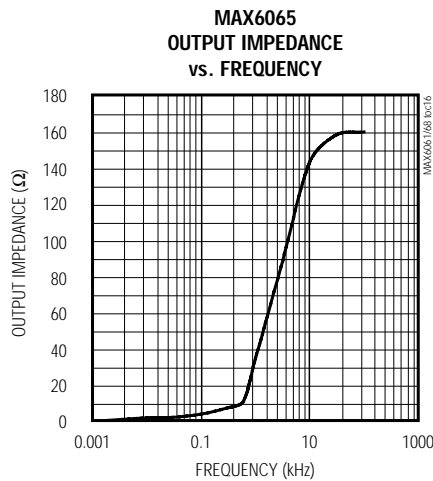
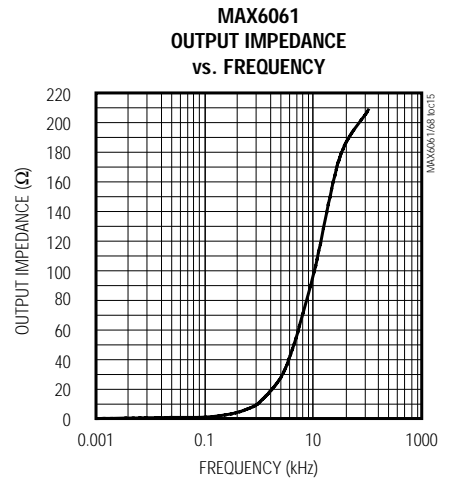
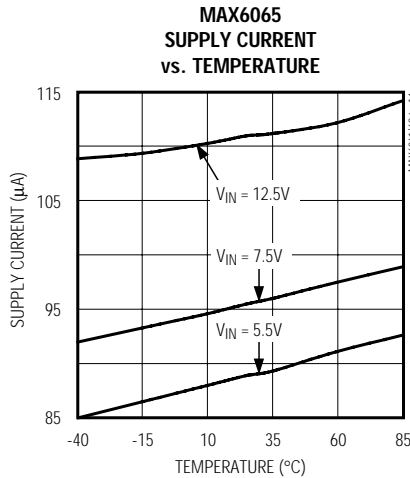
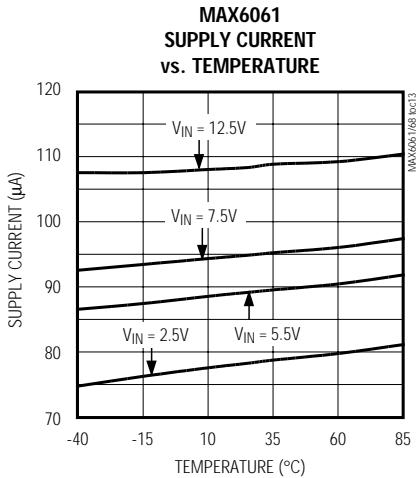
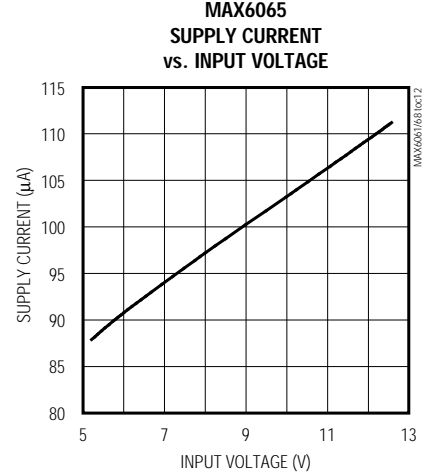
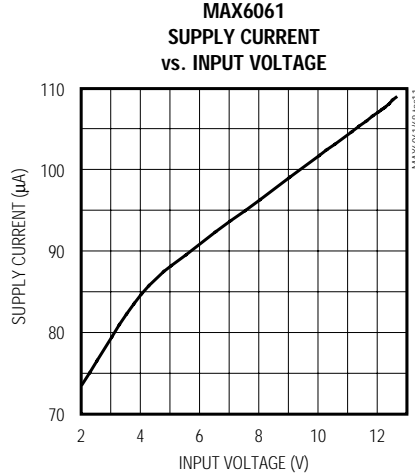
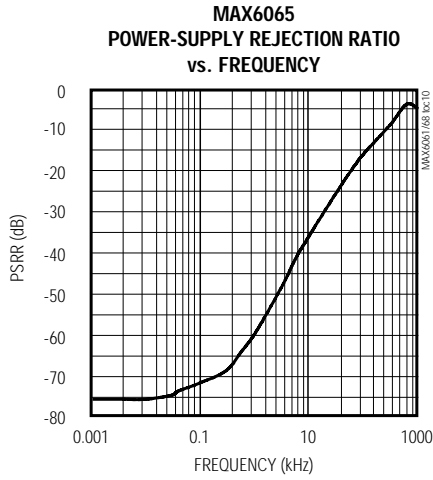

高精度、マイクロパワー、低ドロップアウト 大出力電流、SOT23電圧リファレンス

MAX6061-MAX6068

標準動作特性(続き)

($V_{IN} = +5V$ for MAX6061-MAX6068, $V_{IN} = +5.5V$ for MAX6065, $I_{OUT} = 0$, $T_A = +25^\circ C$, unless otherwise noted.) (Note 5)

**MAX6061
TURN-ON TRANSIENT
($C_L = 50pF$)**

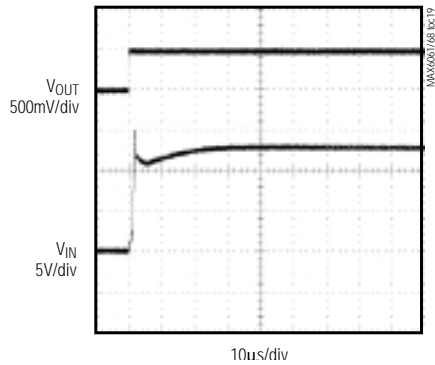

**MAX6065
TURN-ON TRANSIENT
($C_L = 50pF$)**

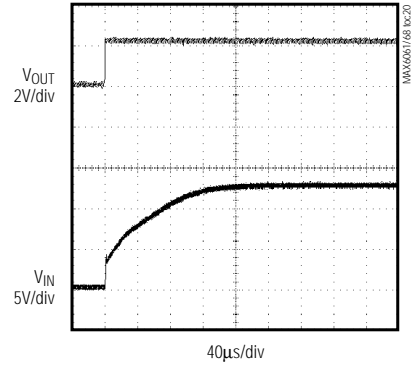

**MAX6061
LOAD TRANSIENT
($I_{OUT} = \pm 250\mu A$, $V_{IN} = 5.0$, $C_L = 0$)**

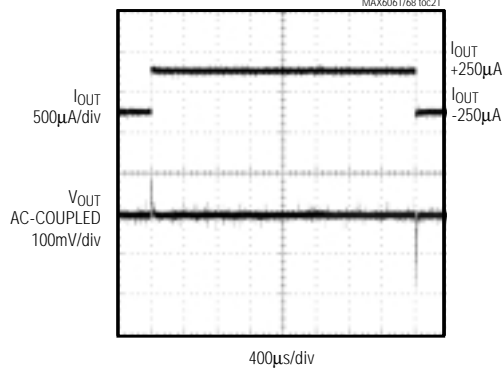

**MAX6065
LOAD TRANSIENT
($I_{OUT} = \pm 250\mu A$, $C_L = 0$, $V_{IN} = 5.5V$)**

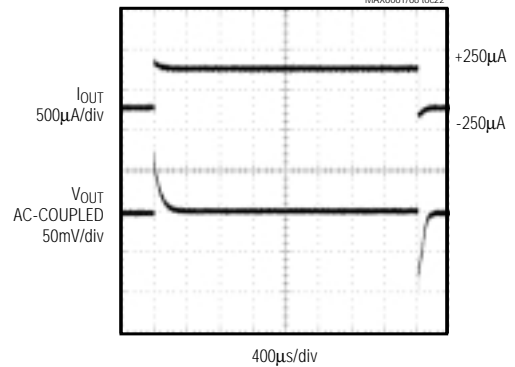

**MAX6061
LOAD TRANSIENT
($I_{OUT} = \pm 250\mu A$, $V_{IN} = 5.0V$, $C_L = 1\mu F$)**

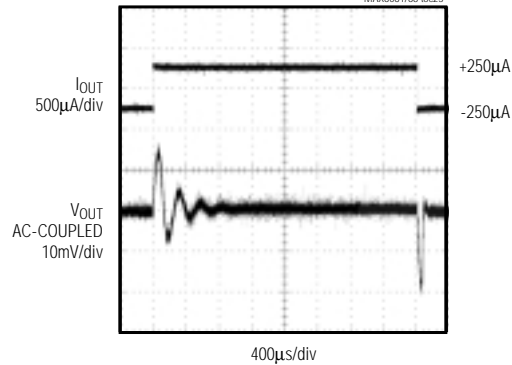

**MAX6065
LOAD TRANSIENT
($I_{OUT} = \pm 250\mu A$, $C_L = 1\mu F$, $V_{IN} = 5.5V$)**

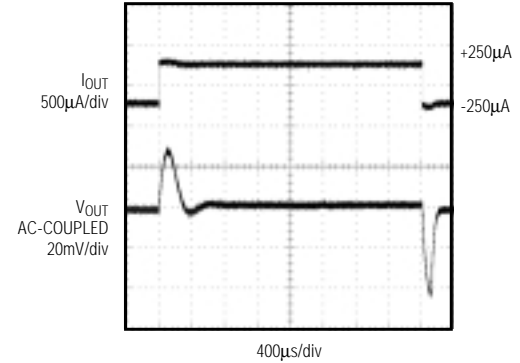

高精度、マイクロパワー、低ドロップアウト 大出力電流、SOT23電圧リファレンス

MAX6061-MAX6068

標準動作特性(続き)

($V_{IN} = +5V$ for MAX6061-MAX6068, $V_{IN} = +5.5V$ for MAX6065, $I_{OUT} = 0$, $T_A = +25^\circ C$, unless otherwise noted.) (Note 5)

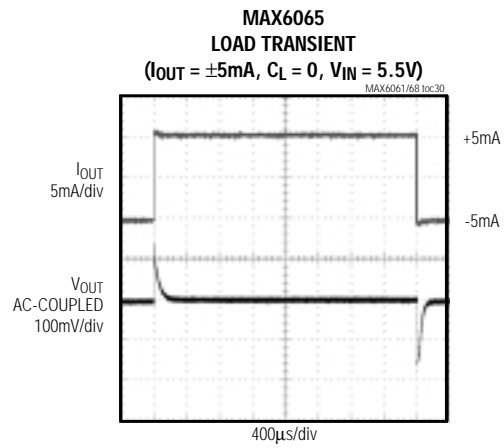
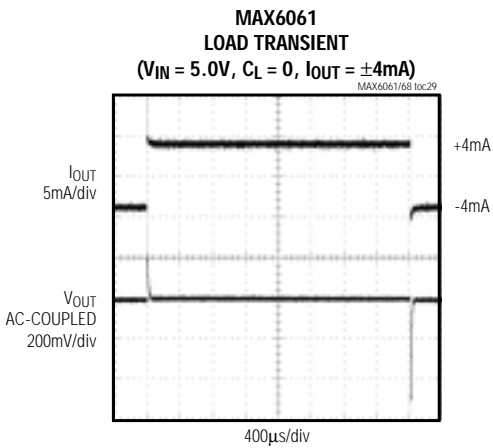
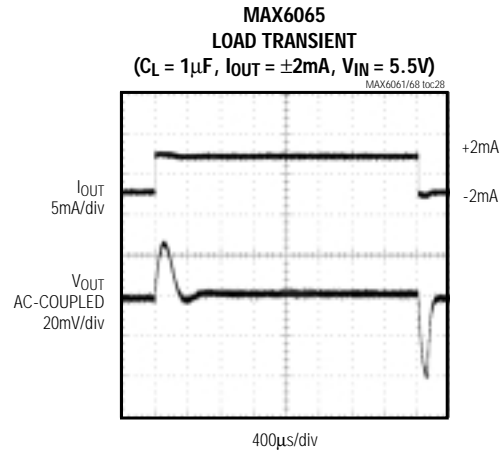
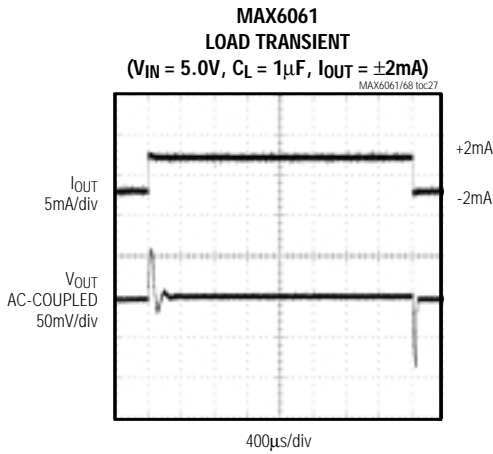
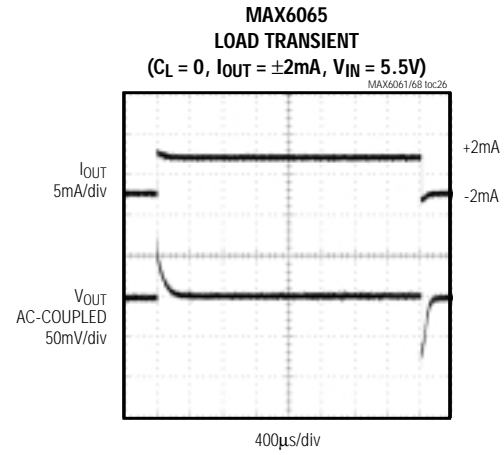
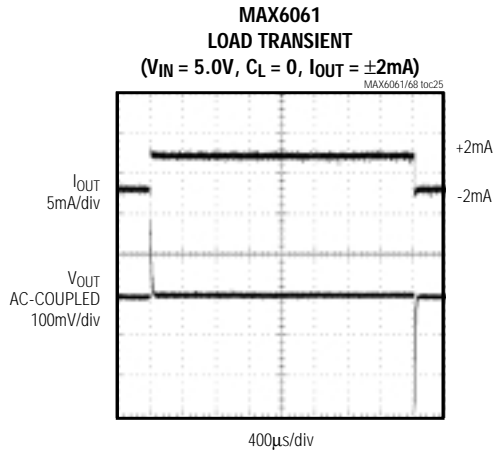

高精度、マイクロパワー、低ドロップアウト 大出力電流、SOT23電圧リファレンス

MAX6061-MAX6068

標準動作特性(続き)

($V_{IN} = +5V$ for MAX6061-MAX6068, $V_{IN} = +5.5V$ for MAX6065, $I_{OUT} = 0$, $T_A = +25^\circ C$, unless otherwise noted.) (Note 5)

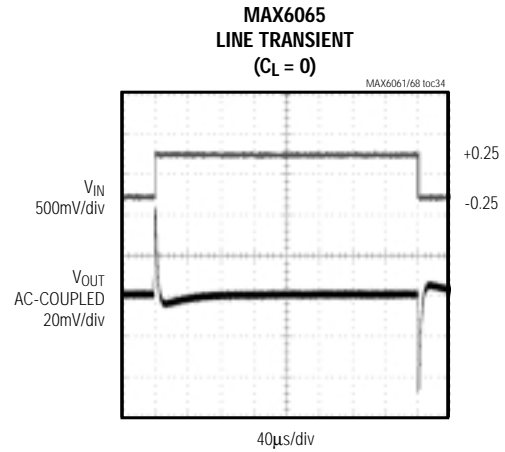
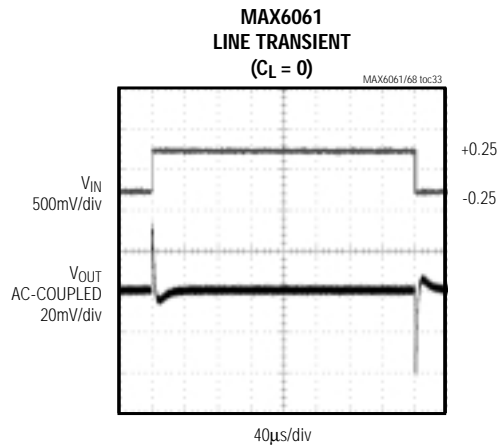
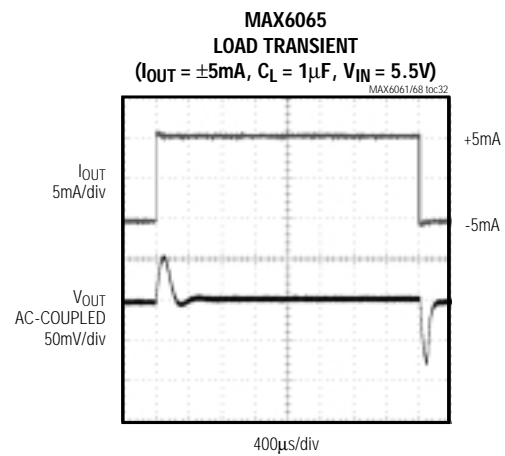
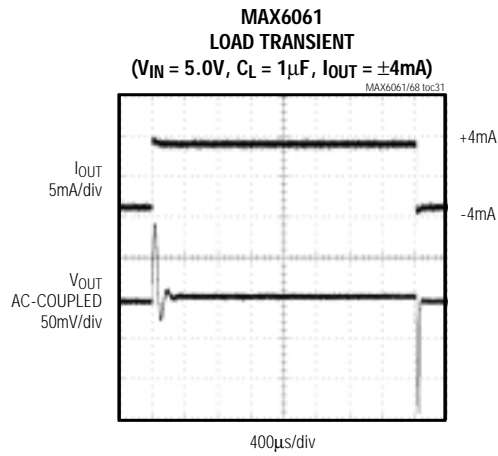

Note 5: Many of the MAX6061 family *Typical Operating Characteristics* are extremely similar. The extremes of these characteristics are found in the MAX6061 (1.25V output) and the MAX6065 (5.0V output). The *Typical Operating Characteristics* of the remainder of the MAX6061 family, typically lie between these two extremes and can be estimated based on their output voltages.

高精度、マイクロパワー、低ドロップアウト 大出力電流、SOT23電圧リファレンス

MAX6061-MAX6068

端子説明

端子	名称	機能
1	IN	入力電圧
2	OUT	リファレンス出力
3	GND	グランド

アプリケーション情報

入力バイパス

最良のライン過渡応答を得るには、「標準動作回路」に示すように0.1 μ Fセラミックコンデンサで入力をデカップリングして下さい。このコンデンサはINのできるだけ近くに配置して下さい。過渡性能が重要でない場合にはコンデンサは必要ありません。

出力/負荷容量

MAX6061ファミリの素子は、周波数安定性のために出力容量を必要としません。負荷又は電源が階段状の変化をする可能性のあるアプリケーションにおいては、少なくとも0.1 μ Fの出力コンデンサを使用することによってオーバシュート(アンダーシュート)を小さくして回路の過渡応答を改善することができます。多くのアプリケーションにおいては外付コンデンサを必要としないため、MAX6061ファミリは基板面積が厳しい時にこれらのアプリケーションにおいて大きな利点を発揮します。

消費電流

直列モードMAX6061ファミリの自己消費電流は90 μ A(typ)で、電源電圧には殆ど影響されません(電源電圧依存性は最大8 μ A/V)。直列リファレンスとは異なり、シャントモードリファレンスは電源に直列抵抗を接続した状態で動作します。つまり、シャントモードリファレンスの自己消費電流は入力電圧の関数になります。さらに、シャントモードリファレンスは、負荷電流がその時に存在しなくても、予想される最大の負荷電流でバイアスされている必要があります。MAX6061ファミリの場合、負荷電流は必要な時にだけ入力電圧から供給されるため、消費電流が浪費されず、全ての入力電圧において効率が最大になります。この効率の改善によって電力消費が低減し、バッテリー寿命が延びます。電源電圧が最小仕様入力電圧よりも低い時(ターンオン時など)、本素子は公称消費電流よりも400 μ A多い電流を消費することがあります。ターンオンを確実にするためには、入力電圧ソースがこの電流を供給できなければなりません。

標準動作回路

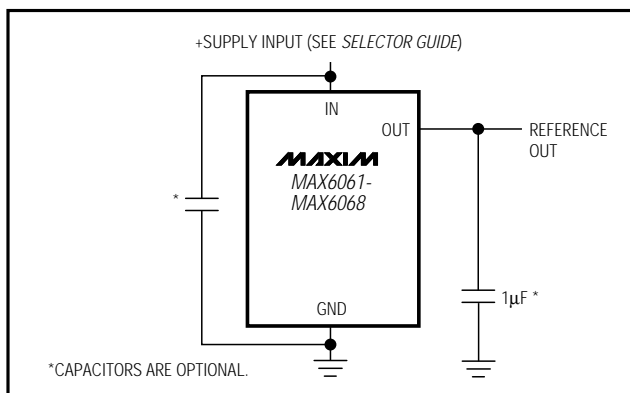

型番(続き)

PART	TEMP. RANGE	PIN-PACKAGE	TOP MARK
MAX6067AEUR-T	-40°C to +85°C	3 SOT23-3	FZFS
MAX6067BEUR-T	-40°C to +85°C	3 SOT23-3	FZFT
MAX6068AEUR-T	-40°C to +85°C	3 SOT23-3	FZIB
MAX6068BEUR-T	-40°C to +85°C	3 SOT23-3	FZIC

出力電圧のヒステリシス

出力電圧のヒステリシスは、素子を動作温度範囲全域でサイクルした前後の $T_A = +25$ における出力電圧の変化です。ヒステリシスは、バンドギャップコアトランジスタの両端のパッケージストレスの差によって生じます。標準的な温度ヒステリシス値は130ppmです。

ターンオン時間

これらの素子は、50 μ s ~ 300 μ s(typ)の間にターンオンして最終値の0.1%以内にセトリングします。素子が最小ドロップアウト電圧及び最大負荷で動作している場合、ターンオン時間は最大1.5msまで増加します。

チップ情報

TRANSISTOR COUNT: 117

PROCESS: BICMOS

高精度、マイクロパワー、低ドロップアウト 大出力電流、SOT23電圧リファレンス

MAX6061-MAX6068

パッケージ

NOTES:

1. D&E DO NOT INCLUDE MOLD FLASH.
2. MOLD FLASH OR PROTRUSIONS NOT TO EXCEED .15mm (.006").
3. CONTROLLING DIMENSION: MILLIMETERS.
4. MEETS JEDEC TO236.

DIM	INCHES		MILLIMETERS	
	MIN	MAX	MIN	MAX
A	0.031	0.047	0.787	1.194
A1	0.001	0.005	0.025	0.127
B	0.014	0.022	0.356	0.559
C	0.0034	0.006	0.086	0.152
D	0.105	0.120	2.667	3.048
E	0.047	0.055	1.194	1.397
e	0.070	0.080	1.778	2.032
H	0.082	0.098	2.083	2.489
L	0.004	0.012	0.102	0.305
S	0.017	0.022	0.432	0.559
α	0°	8°	0°	8°

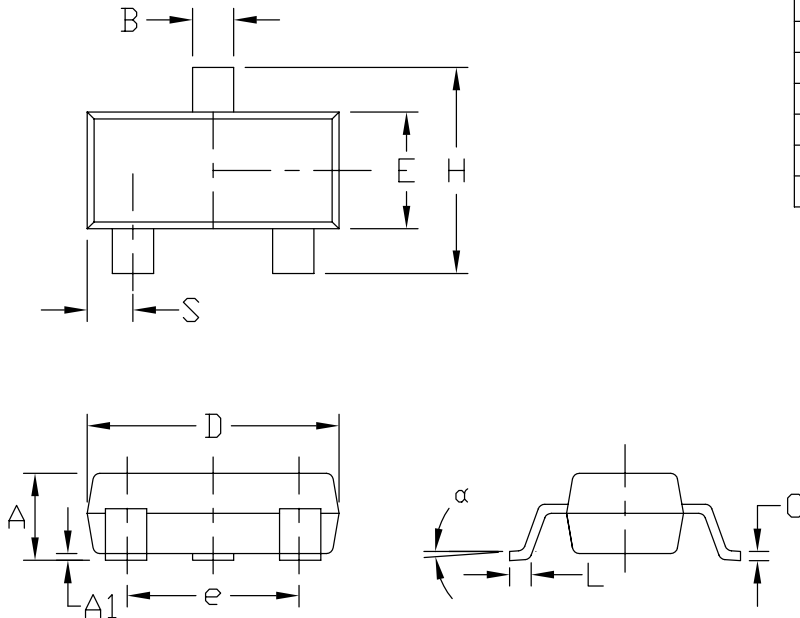

MAXIM			
PROPRIETARY INFORMATION			
TITLE: PACKAGE OUTLINE, SOT-23, 3L			
APPROVAL	DOCUMENT CONTROL NO.	REV	1/1
	21-0051	D	

販売代理店

マキシム・ジャパン株式会社

〒169-0051 東京都新宿区西早稲田3-30-16(ホリゾン1ビル)
TEL. (03)3232-6141 FAX. (03)3232-6149

マキシム社では全体がマキシム社製品で実現されている回路以外の回路の使用については責任を持ちません。回路特許ライセンスは明言されていません。マキシム社は随時予告なしに回路及び仕様を変更する権利を保留します。

16 _____ Maxim Integrated Products, 120 San Gabriel Drive, Sunnyvale, CA 94086 408-737-7600