

# MAXIM

## 900MHz SiGe、高IP3 低ノイズアンプ

MAX2642/MAX2643

### 概要

MAX2642/MAX2643は、セルラ、ISM、SMR及びPMRアプリケーション用に設計された低コスト、高3次インターセプトポイント(IP3)の低ノイズアンプ(LNA)です。これらの製品は、バイアスが設定可能になっているため特定のアプリケーションに合わせてIP3と消費電流を最適化できます。これらのLNAは1.3dBの低雑音指数を維持しつつ、最大0dBmの入力IP3を提供します。

これらの素子の利得は17dB(typ)です。MAX2642は13dBの減衰ステップによってLNAのダイナミックレンジを拡張しています。いずれの素子も、消費電力を最小限に抑えるシャットダウンモードを備えています。オンチップ出力マッチングにより、外付部品点数が削減されるため、基板スペースが節約できます。

MAX2642/MAX2643は低ノイズ、高度シリコンゲルマニウム(SiGe)プロセス技術で設計されています。+2.7V~+5.5Vの単一電源で動作し、超小型6ピンSC70パッケージで提供されています。

### アプリケーション

- 800MHz/900MHzセルラ電話
- 900MHzコードレス電話
- 868MHz/900MHz ISMバンドワイヤレスデータ
- PMR/SMR/LMR

### 標準動作回路

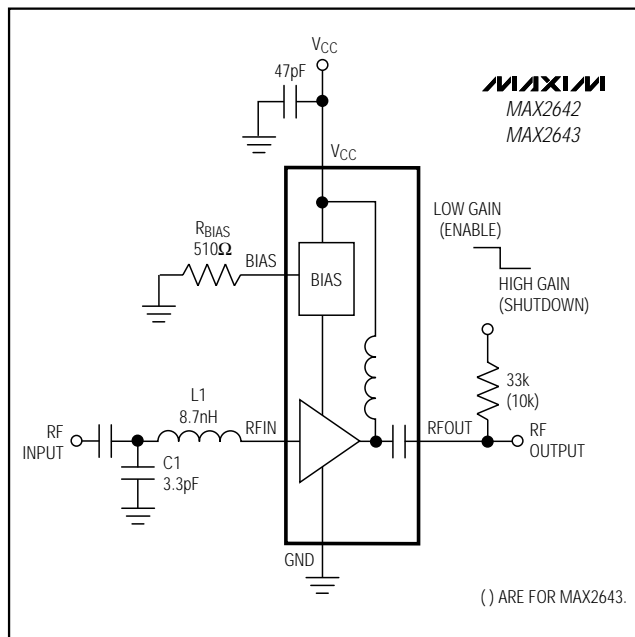

### 特長

- ◆ 広周波数範囲：800MHz~1000MHz
- ◆ 高出力IP3(可変)
  - +17dBm(5.3mA)
  - +7dBm(2.8mA)
- ◆ 低雑音指数：1.3dB(900MHz)
- ◆ 13dBの減衰ステップ(MAX2642)
- ◆ オンチップ出力マッチング
- ◆ 低電力シャットダウンモード
- ◆ 単一電源動作：+2.7V~+5.5V
- ◆ パッケージ：超小型6ピンSC70

### 型番

PART	TEMP. RANGE	PIN-PACKAGE	TOP MARK
MAX2642EXT-T	-40°C to +85°C	6 SC70-6	AAC
MAX2643EXT-T	-40°C to +85°C	6 SC70-6	AAD

### ピン配置

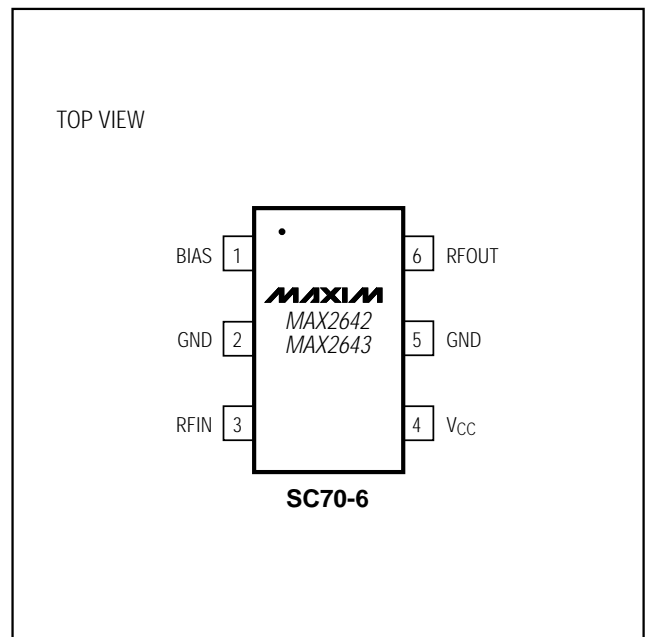

# 900MHz SiGe、高IP3 低ノイズアンプ

MAX2642/MAX2643

## ABSOLUTE MAXIMUM RATINGS

V<sub>CC</sub> to GND .....-0.3V to +6V  
 RFOUT to GND.....-0.3V to (V<sub>CC</sub> + 0.3V)  
 RFIN to GND .....0 to 0.9V  
 RFIN Power (50Ω source) .....+5dBm  
 BIAS to GND .....0 to +0.3V  
 Operating Temperature Range .....-40°C to +85°C

Maximum Junction Temperature .....+150°C  
 Continuous Power Dissipation (T<sub>A</sub> = +70°C)  
     SC70-6 (derate 3.1mW/°C above +70°C) .....245mW  
 Storage Temperature Range .....-65°C to +150°C  
 Lead Temperature (soldering, 10s) .....+300°C

Stresses beyond those listed under "Absolute Maximum Ratings" may cause permanent damage to the device. These are stress ratings only, and functional operation of the device at these or any other conditions beyond those indicated in the operational sections of the specifications is not implied. Exposure to absolute maximum rating conditions for extended periods may affect device reliability.

## DC ELECTRICAL CHARACTERISTICS—MAX2642

(V<sub>CC</sub> = +2.7V to +5.5V, T<sub>A</sub> = -40°C to +85°C, no RF signal applied, RFIN and RFOUT are AC-coupled and terminated to 50Ω, high-gain mode. Typical values are at V<sub>CC</sub> = 3.0V, T<sub>A</sub> = +25°C, unless otherwise noted.) (Notes 1, 2, 3)

PARAMETER	CONDITIONS	MIN	TYP	MAX	UNITS
Supply Voltage		2.7		5.5	V
Operating Supply Current	High-gain mode, R <sub>BIAS</sub> = 510Ω, T <sub>A</sub> = +25°C		5.3	6.7	mA
	R <sub>BIAS</sub> = 510Ω, T <sub>A</sub> = -40°C to +85°C			7.5	
	R <sub>BIAS</sub> = 806Ω		3.6		
	R <sub>BIAS</sub> = 1.1kΩ		2.8		
	Low-gain mode, R <sub>BIAS</sub> = 510Ω, T <sub>A</sub> = 25°C		5.9		
Shutdown Supply Current	BIAS = unconnected (see <i>Applications Information</i> )		0.2		mA
Gain Control Voltage Input	High-gain mode (Note 4)			0.6	V
	Low-gain mode (Note 5)	2.0			
Gain Control Input Current	High-gain mode (Note 6)	-10		0	μA
	Low-gain mode (Note 7)	0		50	

## DC ELECTRICAL CHARACTERISTICS—MAX2643

(V<sub>CC</sub> = +2.7V to +5.5V, T<sub>A</sub> = -40°C to +85°C, no RF signal applied, RFIN and RFOUT are AC-coupled and terminated to 50Ω. Typical values are at V<sub>CC</sub> = 3.0V, T<sub>A</sub> = +25°C, unless otherwise noted.) (Notes 1, 8, 9)

PARAMETER	CONDITIONS	MIN	TYP	MAX	UNITS
Supply Voltage		2.7		5.5	V
Operating Supply Current	R <sub>BIAS</sub> = 510Ω, T <sub>A</sub> = +25°C		5.1	6.5	mA
	R <sub>BIAS</sub> = 510Ω, T <sub>A</sub> = -40°C to +85°C			7.3	
	R <sub>BIAS</sub> = 806Ω		3.4		
	R <sub>BIAS</sub> = 1.1kΩ		2.6		
Shutdown Supply Current	Shutdown mode (see <i>Applications Information</i> )		0.2	10	μA
Shutdown Control Input Voltage	Normal operation (Note 10)	2.0			V
	Shutdown mode (Note 11)			0.6	
Shutdown Control Input Current	Normal operation (Note 7)	0		10	μA
	Shutdown mode (Note 6)	-5		5	

## AC ELECTRICAL CHARACTERISTICS

(MAX2642/MAX2643 EV kits, PRFIN = -30dBm, f<sub>RFIN</sub> = 900MHz, input and output are terminated to 50Ω, V<sub>CC</sub> = +3.0V, T<sub>A</sub> = +25°C, R<sub>BIAS</sub> = 510Ω, unless otherwise noted.) (Note 12)

PARAMETER	CONDITIONS	MIN	TYP	MAX	UNITS
Operating Frequency Range	(Note 13)	800		1000	MHz
Gain (Note 14)	T <sub>A</sub> = +25°C	14.5	16.7	19	dB
Gain Variation Over Temperature	T <sub>A</sub> = -40°C to +85°C		±0.35	±0.75	dB
Attenuation Step	MAX2642 only		13		dB
Input Third-Order Intercept Point (Note 15)	R <sub>BIAS</sub> = 510Ω		0		dBm
	R <sub>BIAS</sub> = 806Ω		-5		
	R <sub>BIAS</sub> = 1.1kΩ		-10		
Input 1dB Compression Point			-18		dBm
	MAX2642, low-gain mode		-17		
Noise Figure (Note 16)			1.35	1.6	dB
	MAX2642, low-gain mode		4.3		
Input Return Loss		-10	-12		dB
	MAX2642, low-gain mode	-10	-18		
Output Return Loss		-10	-14		dB
	MAX2642, low-gain mode	-10	-11		
Reverse Isolation		-20	-26		dB
	MAX2642, low-gain mode	-10	-17		
Gain-Step Response Time	MAX2642		5	10	μs
Shutdown Response Time	MAX2643		6	10	μs
	MAX2642, through series switch at BIAS		12		

- Note 1:** Devices are production tested at T<sub>A</sub> = +25°C. Minimum and maximum values are guaranteed by design and characterization over temperature and supply voltage.
- Note 2:** High-gain mode is set for the MAX2642 by connecting RFOUT to GND through a 33kΩ resistor.
- Note 3:** Low-gain mode is applicable only to the MAX2642 and is set by connecting RFOUT to V<sub>CC</sub> through a 33kΩ resistor.
- Note 4:** Maximum DC voltage through a 33kΩ resistor that sets the MAX2642 to operate in high-gain mode.
- Note 5:** Minimum DC voltage through a 33kΩ resistor that sets the MAX2642 to operate in low-gain mode.
- Note 6:** DC current required when RFOUT is connected to GND through a 33kΩ resistor (MAX2642) and 10kΩ resistor (MAX2643).
- Note 7:** DC current required when RFOUT is connected to V<sub>CC</sub> through a 33kΩ resistor (MAX2642) and 10kΩ resistor (MAX2643).
- Note 8:** Normal operation is set for the MAX2643 by connecting RFOUT to V<sub>CC</sub> through a 10kΩ resistor.
- Note 9:** Shutdown is set for the MAX2643 by connecting RFOUT to GND through a 10kΩ resistor.
- Note 10:** Minimum DC voltage through a 10kΩ resistor that sets the MAX2643 to operate in normal mode.
- Note 11:** Maximum DC voltage through a 10kΩ resistor that sets the MAX2643 to operate in shutdown mode.
- Note 12:** Min/Max limits are guaranteed by design and characterization, except gain is production tested at T<sub>A</sub> = +25°C.
- Note 13:** The part has been characterized at the specified frequency range. Operation outside this range is possible but not guaranteed.
- Note 14:** Devices are production tested at T<sub>A</sub> = +25°C.
- Note 15:** Measured with two input tones, f<sub>1</sub> = 895MHz and f<sub>2</sub> = 905MHz, both at -30dBm per tone.
- Note 16:** Excludes PC board losses (0.25dB typical at the input of the MAX2642/MAX2643 EV kit).

# 900MHz SiGe、高IP3 低ノイズアンプ

MAX2642/MAX2643

## 標準動作特性

(MAX2642/MAX2643 EV kits,  $V_{CC} = +3.0V$ ,  $P_{RFIN} = -30dBm$ , input and output are terminated to  $50\Omega$ ,  $f_{RFIN} = 900MHz$ ,  $R_{BIAS} = 510\Omega$ , high-gain mode (low-gain mode is applicable only to the MAX2642),  $T_A = +25^\circ C$ , unless otherwise noted.)

### MAX2642

INPUT THIRD-ORDER INTERCEPT vs.  $R_{BIAS}$  (HIGH GAIN)

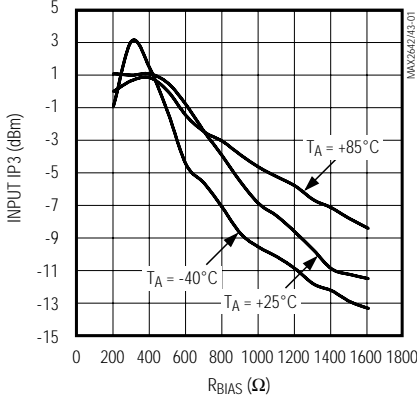

INPUT THIRD-ORDER INTERCEPT vs.  $R_{BIAS}$  (LOW GAIN)

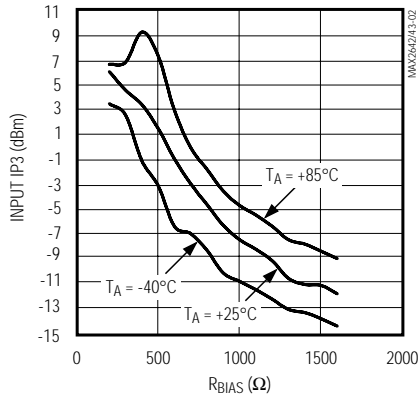

NOISE FIGURE vs. FREQUENCY

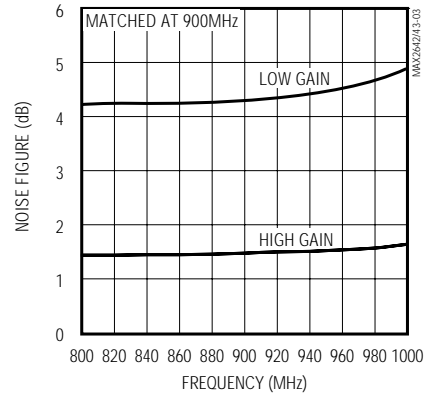

NOISE FIGURE vs. TEMPERATURE

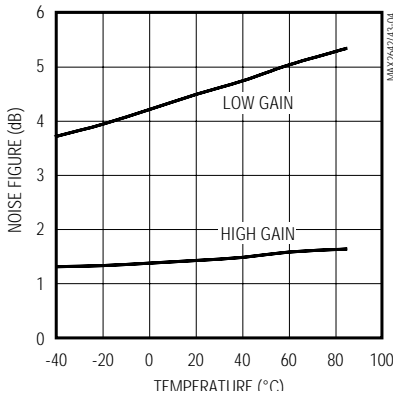

P1dB vs.  $R_{BIAS}$

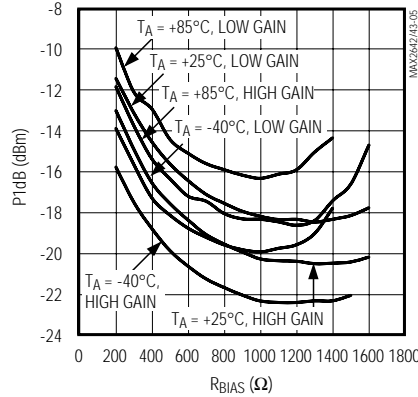

OUTPUT POWER vs. INPUT POWER

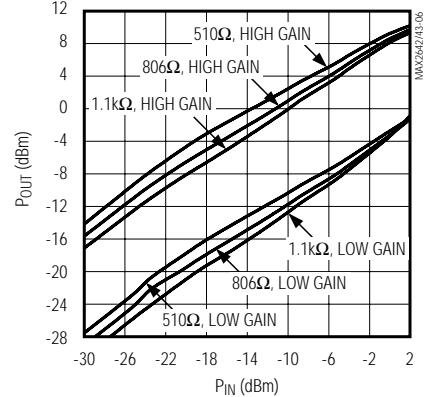

GAIN vs.  $R_{BIAS}$

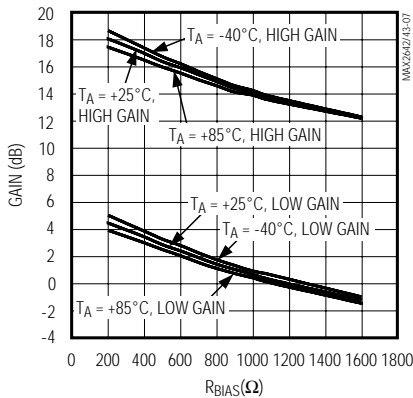

GAIN vs. SUPPLY VOLTAGE

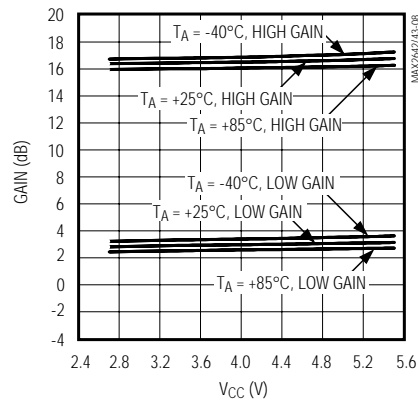

GAIN vs. FREQUENCY

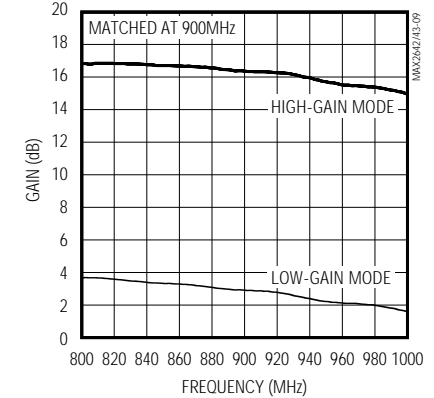

# 900MHz SiGe、高IP3 低ノイズアンプ

MAX2642/MAX2643

## 標準動作特性(続き)

(MAX2642/MAX2643 EV kits,  $V_{CC} = +3.0V$ ,  $P_{RFIN} = -30dBm$ , input and output are terminated to  $50\Omega$ ,  $f_{RFIN} = 900MHz$ ,  $R_{BIAS} = 510\Omega$ , high-gain mode (low-gain mode is applicable only to the MAX2642),  $T_A = +25^\circ C$ , unless otherwise noted.)

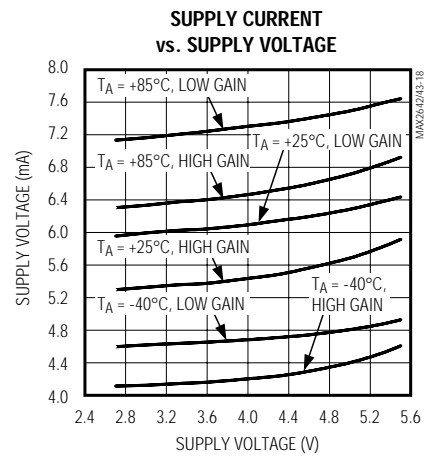
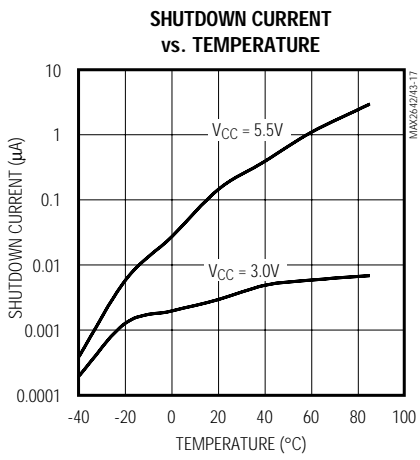
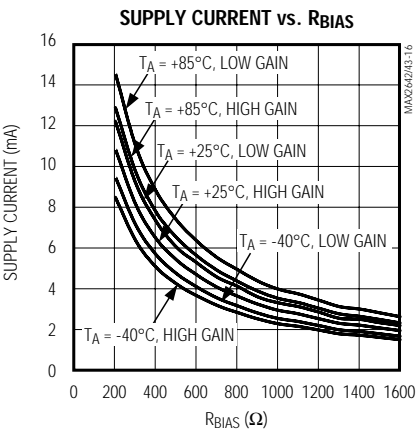
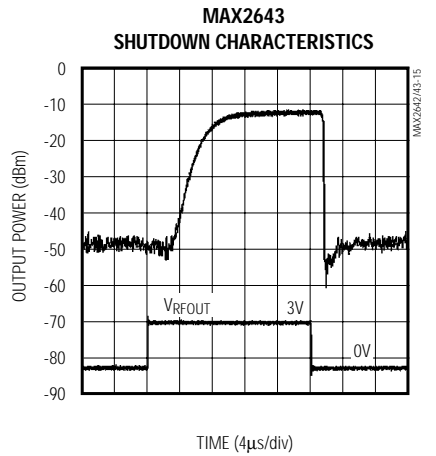
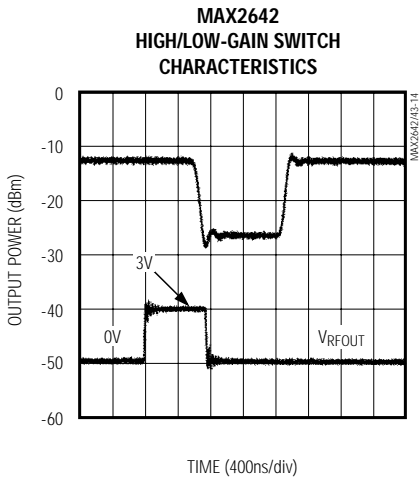
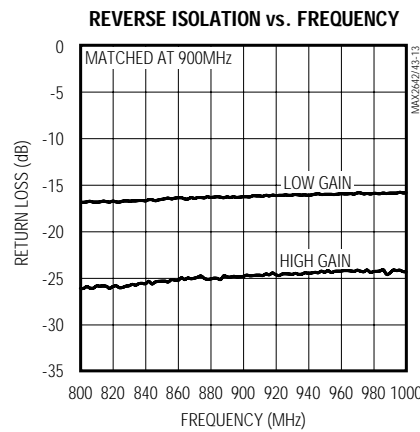
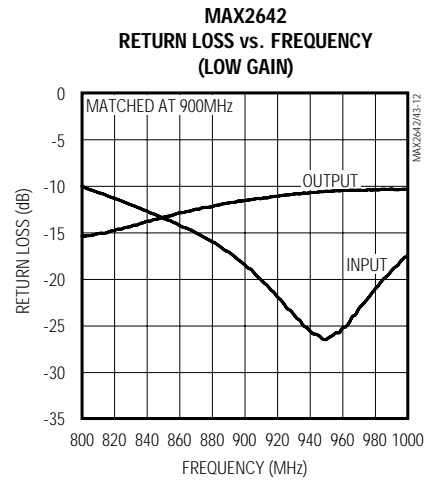
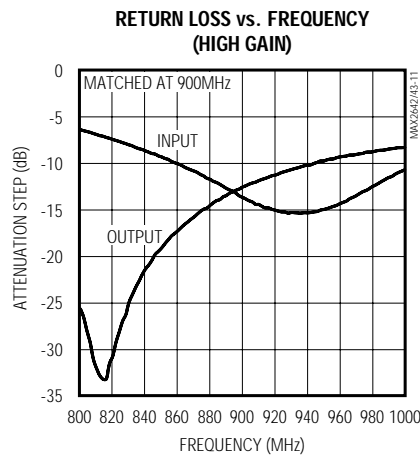
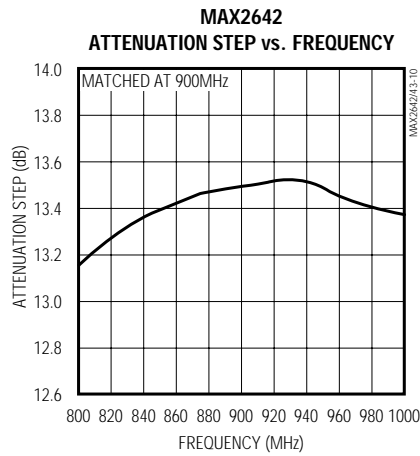

# 900MHz SiGe、高IP3 低ノイズアンプ

MAX2642/MAX2643

## 端子説明

端子	名称	機能
1	BIAS	抵抗バイアス制御。BIASとグランドの間に抵抗 $R_{BIAS}$ を接続して下さい。 $R_{BIAS}$ はIP3と消費電流を設定します(「アプリケーション情報」を参照)。このピンを流れる電流は、50mVを $R_{BIAS}$ で割った値にほぼ等しくなります。
2, 5	GND	グランド。最適の性能を得るには、グランドプレーンへの接続経路を低インダクタンスにして下さい。
3	RFIN	アンプ入力。DCブロッキングコンデンサを使用することにより、このピンにACカップリングして下さい。最適の性能を得るには、外部マッチングネットワークが必要です。
4	VCC	電源電圧。電源ピンのところで47pFコンデンサを使用し、グランドに直接バイパスして下さい。 $V_{CC}$ ラインが長い場合には、バイパスを追加することが必要になることもあります。
6	RFOUT	アンプ出力。内部で50 $\Omega$ にマッチングされています。このピンのDCバイアスによって利得モード(MAX2642)又はシャットダウンモード(MAX2643)が選択されます(「アプリケーション情報」を参照)。

## アプリケーション情報

### 入力マッチング

最適の性能を得るには入力マッチングが必要です。MAX2642/MAX2643は、「標準動作回路」に示すようなシンプルなLCマッチングネットワークを必要とします。コストと外付部品点数をさらに削減するには、外部インダクタをマイクロストリップ伝送ラインで置き換えて下さい。「標準動作回路」に900MHzにおけるMAX2642/MAX2643の推奨入力マッチングネットワークを示します。これらの値は利得、雑音指数及びリターンロス性能が同時にベストになるように最適化されています。他の周波数のマッチングネットワーク設計を容易にするため、表1~6に様々なバイアスに対する標準素子Sパラメータが、表7、8及び9に標準素子ノイズパラメータが記載されています。

### 減衰ステップ(MAX2642)

MAX2642のRFOUTにおけるDCバイアス電圧は、減衰ステップ入力の役割を果たしています。33k  $\Omega$  抵抗を通じたRFOUTのDC電圧が+0.6V未満の時、素子は高利得モードになります。このDC電圧が+2.0Vを超える時、素子は低利得モードになります。「標準動作回路」に示すように、標準ロジック出力を印加することができます。バイアスがかからないと、素子は高利得モードになります。

### シャットダウン

MAX2643の場合、推奨されるシャットダウン方法は、MAX2642の減衰ステップの場合と同じようにRFOUTのDC電圧を設定することです。すなわち、RFOUTにおけるDC電圧が+0.6V未満であると、素子はシャットダウンします。このDC電圧が+2.0Vを超えると、素子はイネーブルされます。

MAX2642の場合、BIASを未接続のままにすることによってシャットダウンが実現されます。図1に、推奨されるシャットダウン方法が示されています。BIASとスイッチの間にバイアス抵抗を接続することにより、BIASピンにおける容量を避けて下さい。表10に動作モードがまとめてあります。

### レイアウト上の問題

RF/マイクロ波回路には、適正に設計されたプリント基板が必須です。全ての高周波入出力にインピーダンスが制御されたラインを使って下さい。素子の $V_{CC}$ ピンの近くに配置されたデカップリングコンデンサでバイパスして下さい。 $V_{CC}$ ラインが長い場合は、デカップリングコンデンサを追加する必要があるかもしれません。これらの追加コンデンサは素子パッケージから離れた位置でも構いません。GNDピンを適正に接地することが重要です。プリント基板が上面RFグランドを使用している場合は、このグランドを全てのGNDピンに直接接続して下さい。グランドプレーンが部品層にないプリント基板の場合は、パッケージの近くのメッキスルーホールを使ってGNDピンを基板に接続するのが最善です。

# 900MHz SiGe、高IP3 低ノイズアンプ

表1. MAX2642/MAX2643の標準Sパラメータ

(RBIAS = 510、高利得モード、VCC = +3.0V、TA = +25 )

FREQ (MHz)	S11 MAG	S11 PHASE (DEGREES)	S21 MAG	S21 PHASE (DEGREES)	S12 MAG	S12 PHASE (DEGREES)	S22 MAG	S22 PHASE (DEGREES)
500	0.832641	-69.5831	2.390806	-119.18	0.010763	166.6047	0.878515	-74.01422
600	0.825168	-83.7622	3.836967	-136.451	0.019608	167.8741	0.731997	-98.95091
700	0.785389	-97.3356	4.983279	-161.126	0.02988	148.5203	0.481344	-125.1027
800	0.73798	-108.682	5.320575	174.5337	0.036197	134.8794	0.215462	-142.0387
820	0.728099	-110.578	5.286	170.3323	0.037193	132.505	0.171633	-141.9486
840	0.718704	-112.499	5.241719	166.3987	0.037266	129.1671	0.135415	-139.9869
860	0.711335	-114.276	5.185213	162.4763	0.039143	128.0447	0.100779	-133.8375
880	0.705742	-115.973	5.118265	158.9238	0.039563	128.4158	0.076864	-121.3533
900	0.699509	-117.585	5.050356	155.6292	0.042586	128.075	0.062918	-102.3972
920	0.695913	-119.117	4.973824	152.4338	0.041805	126.9362	0.06007	-81.32555
940	0.690406	-120.995	4.897571	149.4286	0.04301	122.9564	0.065287	-62.51575
960	0.68522	-122.642	4.826106	146.6999	0.046528	122.0997	0.077374	-50.8638
980	0.681722	-124.345	4.735407	143.8275	0.04524	121.0474	0.090494	-44.30662
1000	0.675328	-126.035	4.650673	141.4611	0.046036	120.1779	0.103072	-40.69565
1100	0.657582	-134.195	4.29304	130.7613	0.053825	116.4169	0.156945	-34.00603
1200	0.635999	-141.558	3.998256	121.5475	0.061434	109.6365	0.198686	-32.62157
1300	0.616881	-147.886	3.777511	113.2893	0.066092	103.583	0.240437	-33.12784
1400	0.602418	-153.992	3.547677	105.6808	0.075756	99.08275	0.283245	-36.62076
1500	0.587409	-158.21	3.338385	97.62961	0.076491	92.84421	0.326279	-40.68451

MAX2642/MAX2643

# 900MHz SiGe、高IP3 低ノイズアンプ

MAX2642/MAX2643

表2. MAX2642/MAX2643の標準Sパラメータ

(RBIAS = 806 、高利得モード、VCC = +3.0V、TA = +25 )

FREQ (MHz)	S11 MAG	S11 PHASE (DEGREES)	S21 MAG	S21 PHASE (DEGREES)	S12 MAG	S12 PHASE (DEGREES)	S22 MAG	S22 PHASE (DEGREES)
500	0.865705	-67.5629	1.788918	-115.899	0.009763	164.6001	0.880237	-73.81893
600	0.853946	-80.7084	2.926709	-132.446	0.021656	165.374	0.739354	-99.52715
700	0.820187	-94.1329	3.884537	-157.426	0.029766	148.5047	0.49107	-128.1454
800	0.775557	-104.428	4.237314	177.9528	0.036728	130.1148	0.216415	-153.3392
820	0.765138	-106.343	4.226094	173.3886	0.038253	129.5942	0.166772	-157.7809
840	0.759	-108.042	4.214913	169.298	0.038842	128.7876	0.121201	-160.7175
860	0.7495	-109.928	4.182436	165.3457	0.040084	127.3742	0.082263	-160.9349
880	0.741722	-111.683	4.134814	161.548	0.04118	127.2791	0.045314	-158.0615
900	0.736069	-113.369	4.085018	157.8688	0.04194	125.3719	0.016624	-133.0426
920	0.728957	-115.127	4.032105	154.6118	0.044642	123.3553	0.021369	-38.41852
940	0.724118	-116.951	3.965561	151.3371	0.044574	121.8034	0.043243	-17.90431
960	0.719676	-118.584	3.903364	148.3141	0.044792	120.7695	0.066898	-14.20027
980	0.714506	-120.313	3.83867	145.3527	0.045551	118.109	0.084163	-12.76007
1000	0.709103	-121.959	3.777	142.7001	0.046434	119.036	0.102269	-13.88384
1100	0.691292	-129.341	3.483283	131.8578	0.054775	114.7347	0.169693	-18.18657
1200	0.67035	-136.703	3.27255	121.9156	0.061407	108.2008	0.220689	-21.72272
1300	0.650556	-143.014	3.09574	113.1691	0.064829	103.5856	0.26965	-24.86245
1400	0.635363	-148.565	2.934971	105.3286	0.075142	97.9223	0.315264	-30.21604
1500	0.616202	-153.536	2.756155	96.43876	0.074664	92.88747	0.360706	-35.70454

# 900MHz SiGe、高IP3 低ノイズアンプ

表3. MAX2642/MAX2643の標準Sパラメータ

(RBIAS = 1.1k 、高利得モード、VCC = +3.0V、TA = +25 )

FREQ (MHz)	S11 MAG	S11 PHASE (DEGREES)	S21 MAG	S11 PHASE (DEGREES)	S12 MAG	S12 PHASE (DEGREES)	S22 MAG	S22 PHASE (DEGREES)
500	0.878512	-66.0475	1.445864	-114.652	0.011049	175.9688	0.882121	-73.97408
600	0.86813	-79.0081	2.398259	-131.281	0.01977	166.0087	0.745577	-100.0799
700	0.834311	-91.9431	3.218232	-155.869	0.033312	149.3926	0.502282	-129.8978
800	0.793611	-102.384	3.544617	179.1002	0.038594	131.9641	0.223248	-160.5161
820	0.783644	-104.098	3.563583	174.4488	0.040112	131.6111	0.173175	-166.8809
840	0.774329	-105.921	3.546937	170.1934	0.038383	128.1902	0.126351	-173.2415
860	0.767016	-107.766	3.529998	165.871	0.04004	126.4807	0.086328	178.6352
880	0.762463	-109.461	3.500193	161.8438	0.041375	124.4402	0.049822	167.1237
900	0.753622	-111.254	3.463616	158.0655	0.043587	123.8527	0.020398	128.5957
920	0.748921	-113.148	3.419726	154.6982	0.043975	123.9237	0.024778	48.71712
940	0.743011	-114.988	3.36768	151.2749	0.045614	121.0385	0.04661	18.5372
960	0.737437	-116.709	3.309045	148.0373	0.044426	118.9012	0.070736	10.02515
980	0.733572	-118.379	3.261195	145.4087	0.046581	118.374	0.092621	4.197083
1000	0.729122	-119.87	3.203007	142.5148	0.048343	116.9249	0.110062	-0.293905
1100	0.710864	-127.286	2.970843	130.8328	0.055616	115.1579	0.183756	-10.46082
1200	0.688941	-134.781	2.789044	120.5809	0.061803	105.9973	0.238134	-16.81635
1300	0.668471	-141.275	2.637086	111.4044	0.065281	100.6171	0.289607	-21.34393
1400	0.655478	-146.685	2.491515	103.3737	0.073887	96.84646	0.335752	-27.6725
1500	0.638124	-152.12	2.352013	94.07729	0.077901	90.34502	0.381179	-33.81158

MAX2642/MAX2643

# 900MHz SiGe、高IP3 低ノイズアンプ

MAX2642/MAX2643

表4. MAX2642の標準Sパラメータ

(RBIAS = 510 、低利得モード、VCC = +3.0V、TA = +25 )

FREQ (MHz)	S11 MAG	S11 PHASE (DEGREES)	S21 MAG	S21 PHASE (DEGREES)	S12 MAG	S12 PHASE (DEGREES)	S22 MAG	S22 PHASE (DEGREES)
500	0.757279	-68.0641	0.186886	-175.019	0.032297	163.9787	0.87996	-73.8882
600	0.75734	-84.3042	0.715305	-146.702	0.066113	148.5775	0.71413	-98.6736
700	0.696969	-98.422	1.140352	-174.61	0.099941	124.8504	0.449346	-121.361
800	0.626874	-107.497	1.272844	157.4571	0.115242	103.1406	0.201112	-127.267
820	0.616023	-108.596	1.267541	152.644	0.116521	100.3007	0.165909	-123.451
840	0.608751	-109.794	1.258504	148.0772	0.117601	97.74948	0.137812	-116.955
860	0.600617	-110.754	1.242296	143.7583	0.119312	95.48379	0.118557	-107.057
880	0.596488	-111.776	1.22394	139.7228	0.122318	93.07481	0.106845	-93.617
900	0.593722	-112.739	1.203776	135.9799	0.124196	90.21815	0.103446	-81.5882
920	0.590101	-113.712	1.181885	132.3471	0.125203	86.9857	0.108109	-70.2192
940	0.588409	-114.834	1.156787	128.909	0.126462	84.27329	0.116508	-61.7886
960	0.589625	-115.806	1.129734	125.6671	0.127369	82.07469	0.129083	-55.1485
980	0.588079	-116.828	1.102653	122.5478	0.127952	80.98836	0.140436	-52.3827
1000	0.588646	-117.975	1.074686	119.9067	0.12743	79.48192	0.151608	-48.4917
1100	0.597562	-124.002	0.952505	108.5103	0.134236	72.42102	0.206216	-43.8143
1200	0.6066	-129.873	0.852237	99.7348	0.138354	65.08001	0.252003	-43.9084
1300	0.617079	-136.272	0.778154	92.06538	0.142609	58.40858	0.295689	-46.8967
1400	0.628195	-142.195	0.718399	85.7905	0.153771	52.64912	0.33692	-51.7496
1500	0.640304	-147.446	0.656535	78.77735	0.149518	46.71009	0.374046	-56.7658

表5. MAX2642の標準Sパラメータ

(RBIAS = 806 、低利得モード、VCC = +3.0V、TA = +25 )

FREQ (MHz)	S11 MAG	S11 PHASE (DEGREES)	S21 MAG	S21 PHASE (DEGREES)	S12 MAG	S12 PHASE (DEGREES)	S22 MAG	S22 PHASE (DEGREES)
500	0.800327	-67.1945	0.142134	-174.341	0.034805	161.583	0.88084	-73.57176
600	0.793203	-81.9096	0.543072	-143.848	0.067027	146.5234	0.719105	-99.08562
700	0.736656	-95.21	0.885917	-171.542	0.101665	122.4962	0.449898	-124.5513
800	0.676741	-103.586	1.005172	159.8524	0.114894	101.0446	0.183694	-136.0146
820	0.666567	-104.763	1.005053	154.9507	0.115809	97.08399	0.143872	-133.6185
840	0.660377	-106.009	0.998032	150.1753	0.118042	94.72314	0.109486	-125.307
860	0.651791	-107.125	0.990225	145.7345	0.118937	91.64486	0.085206	-112.6535
880	0.651106	-108.175	0.978178	141.4141	0.121575	89.19647	0.071836	-92.15154
900	0.643048	-109.302	0.961026	137.4554	0.120654	86.75212	0.0738	-70.16955
920	0.643064	-110.728	0.942776	133.7632	0.123645	83.74419	0.084769	-54.68721
940	0.641773	-111.842	0.923851	130.1361	0.123333	80.71953	0.098778	-46.62902
960	0.640079	-113.103	0.90238	126.9098	0.12394	78.64308	0.117484	-40.63098
980	0.641175	-114.555	0.879907	123.7699	0.123001	76.38534	0.132356	-38.28101
1000	0.641025	-115.739	0.857382	120.9598	0.122316	74.64619	0.145883	-35.93101
1100	0.647379	-121.754	0.760331	109.613	0.127968	68.72507	0.209937	-35.70716
1200	0.651053	-128.101	0.685309	100.4887	0.131962	62.04964	0.260554	-37.84105
1300	0.65637	-134.578	0.623917	93.1824	0.132337	56.01043	0.303628	-41.83445
1400	0.662035	-139.905	0.582929	86.98415	0.142149	51.5965	0.34549	-46.96146
1500	0.665418	-145.73	0.53929	79.50793	0.138295	45.87176	0.382116	-52.44192

# 900MHz SiGe、高IP3 低ノイズアンプ

MAX2642/MAX2643

表6. MAX2642の標準Sパラメータ

(RBIAS = 1.1k 、低利得モード、VCC = +3.0V、TA = +25 )

FREQ (MHz)	S11 MAG	S11 PHASE (DEGREES)	S21 MAG	S21 PHASE (DEGREES)	S12 MAG	S12 PHASE (DEGREES)	S22 MAG	S22 PHASE (DEGREES)
500	0.822139	-66.5029	0.116321	-174.275	0.03386	162.1213	0.879442	-73.74798
600	0.808058	-80.314	0.439837	-143.103	0.065964	146.0581	0.724703	-99.6653
700	0.755255	-93.0574	0.72921	-170.915	0.0999	121.1126	0.457496	-126.0206
800	0.703243	-101.403	0.838753	160.4014	0.115609	98.56961	0.181063	-141.9359
820	0.694461	-102.693	0.839017	155.3972	0.116069	94.64113	0.138616	-140.7761
840	0.687512	-103.96	0.836295	150.551	0.117021	92.14834	0.098228	-136.1769
860	0.683106	-105.16	0.82921	145.8221	0.116949	88.49732	0.068493	-122.4536
880	0.678346	-106.424	0.818297	141.5384	0.119552	86.39616	0.049577	-93.92001
900	0.674815	-107.654	0.807407	137.4799	0.121372	83.98519	0.052964	-64.05054
920	0.672424	-109.092	0.791395	133.7297	0.122328	80.33097	0.070844	-44.45571
940	0.671111	-110.488	0.775375	129.9834	0.120584	78.46327	0.089595	-37.15094
960	0.669825	-111.738	0.757139	126.6652	0.120221	75.62165	0.110248	-31.16879
980	0.670457	-113.266	0.737655	123.3462	0.120881	73.65825	0.125584	-29.76813
1000	0.669392	-114.649	0.719178	120.6109	0.11967	71.31908	0.14489	-28.6178
1100	0.674741	-120.914	0.638029	109.1083	0.123318	66.28802	0.21152	-30.89364
1200	0.675283	-127.763	0.575544	100.3768	0.125601	58.42145	0.264377	-34.10688
1300	0.679379	-134.523	0.52948	92.75184	0.126691	54.07481	0.308252	-38.78385
1400	0.682813	-139.869	0.494615	86.94255	0.133067	49.83734	0.348366	-44.59462
1500	0.681251	-145.854	0.462984	79.4068	0.128294	43.41453	0.386044	-50.022

表7. MAX2642/MAX2643の標準ノイズパラメータ

( $R_{BIAS} = 510$ 、高利得モード、 $V_{CC} = +3.0V$ 、 $T_A = +25$ )

FREQUENCY (MHz)	NFMIN (dB)	$\Gamma_{opt}$ MAG	$\Gamma_{opt}$ PHASE (DEGREES)	$R_N$ ( $\Omega$ )
800	1.011	0.3074	55.04	13.11
850	1.023	0.3016	58.89	13.28
875	1.030	0.2990	60.83	13.38
900	1.037	0.2965	62.77	13.49
925	1.045	0.2942	64.70	13.60
950	1.053	0.2919	66.62	13.72
1000	1.069	0.2879	70.40	13.96

表8. MAX2642/MAX2643の標準ノイズパラメータ

( $R_{BIAS} = 806$ 、高利得モード、 $V_{CC} = +3.0V$ 、 $T_A = +25$ )

FREQUENCY (MHz)	NFMIN (dB)	$\Gamma_{opt}$ MAG	$\Gamma_{opt}$ PHASE (DEGREES)	$R_N$ ( $\Omega$ )
800	1.149	0.3905	54.95	15.14
850	1.161	0.3832	58.63	15.32
875	1.168	0.3798	60.49	15.43
900	1.176	0.3766	62.35	15.55
925	1.185	0.3735	64.21	15.68
950	1.194	0.3705	66.06	15.82
1000	1.213	0.3650	69.72	16.11

表9. MAX2642/MAX2643の標準ノイズパラメータ

( $R_{BIAS} = 1.1k$ 、高利得モード、 $V_{CC} = +3.0V$ 、 $T_A = +25$ )

FREQUENCY (MHz)	NFMIN (dB)	$\Gamma_{opt}$ MAG	$\Gamma_{opt}$ PHASE (DEGREES)	$R_N$ ( $\Omega$ )
800	1.312	0.4473	55.50	17.64
850	1.325	0.4391	59.12	17.83
875	1.333	0.4353	60.96	17.96
900	1.342	0.4317	62.79	18.11
925	1.352	0.4282	64.63	18.26
950	1.363	0.4249	66.46	18.43
1000	1.385	0.4186	70.08	18.78

# 900MHz SiGe、高IP3 低ノイズアンプ

MAX2642/MAX2643



図1. MAX2642の推奨シャットダウン構成

表10. 利得の選択及びシャットダウンモード

PART	CONTROL VOLTAGE = $V_{CC}$	CONTROL VOLTAGE = 0
MAX2642	Low Gain	High Gain
MAX2643	Enabled	Shutdown

## チップ情報

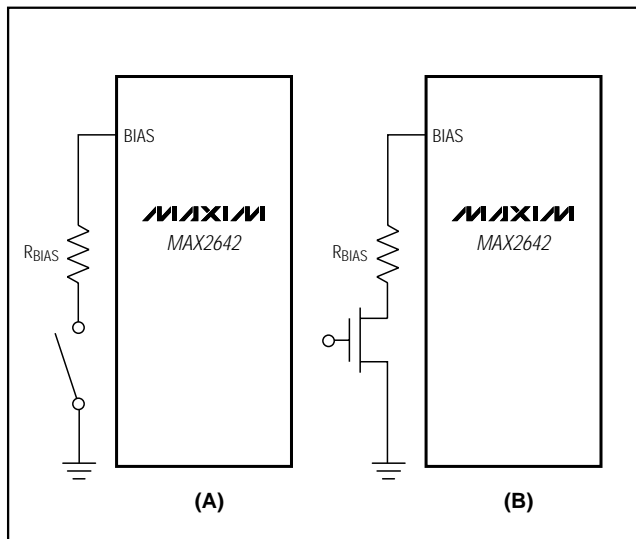
TRANSISTOR COUNT: 158

# 900MHz SiGe、高IP3 低ノイズアンプ

## パッケージ

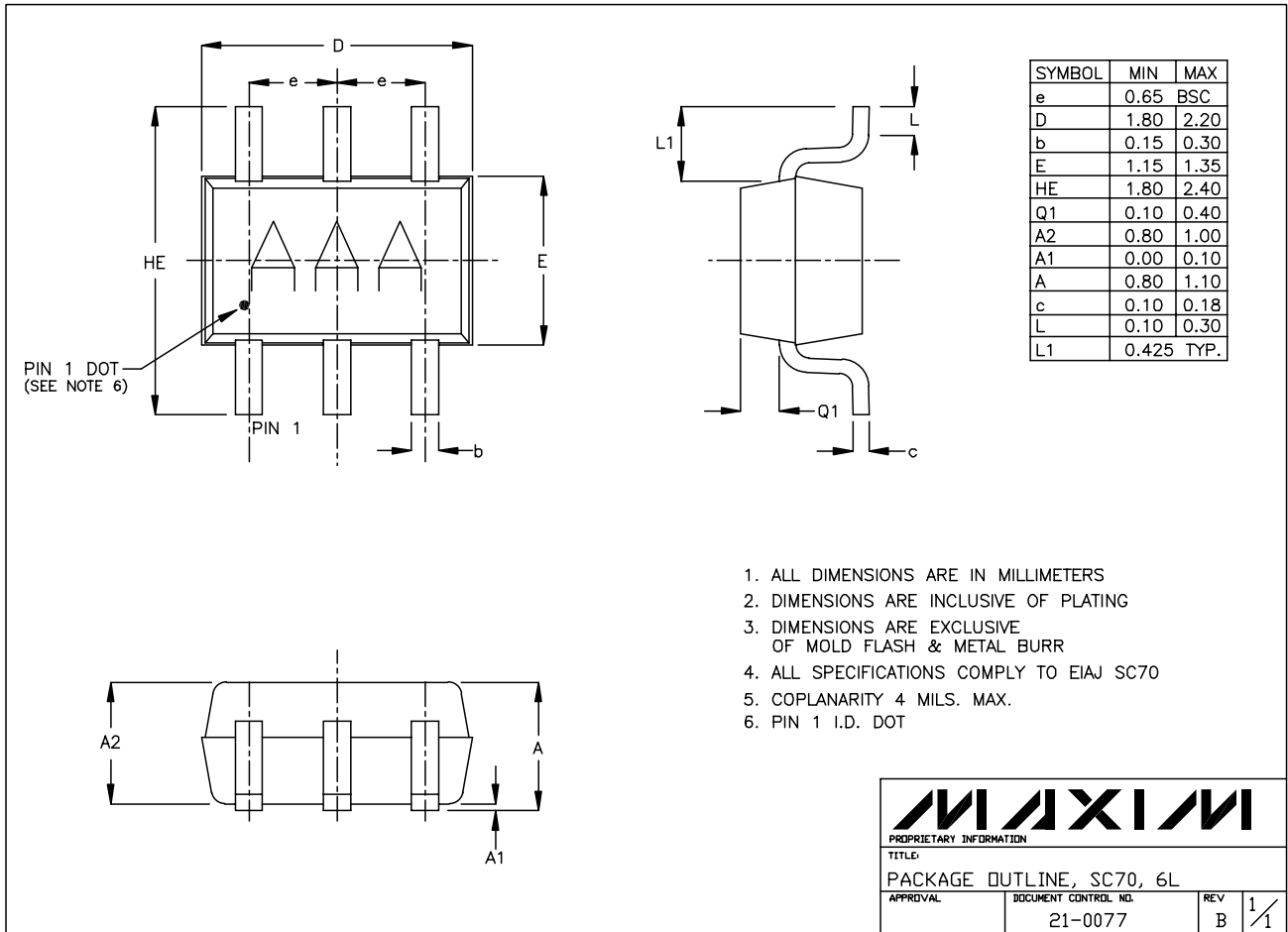

SC70, 6LEPS

MAX2642/MAX2643

900MHz SiGe、高IP3  
低ノイズアンプ

---

MAX2642/MAX2643

NOTES