

# MAXIM

## MXL1543 Evaluation Kit

### General Description

The MXL1543 evaluation kit (EV kit) combines Maxim's multiprotocol clock/data transceiver (MXL1543), control transceiver (MXL1544), and cable terminator (MXL1344A) chips. This chipset forms a complete software-selectable multiprotocol data terminal equipment (DTE) or data communications equipment (DCE) interface port.

The MXL1543, MXL1544, and MXL1344A chipset supports V.28 (RS-232), V.11(RS-449/V.36, EIA530, EIA530-A, X.21), and V.35 protocols. NET1, NET2, TBR-1, and TBR-2 compliance has been certified by TUV Telecom Services, Inc. Internal charge pumps allow this kit to operate off a single +5V supply.

The MXL1543 EV kit was designed to take advantage of the chipset's flow-through pinout. This kit includes a 40-pin header (logic signals), a female DB25 connector (protocol signals), three SMA connectors (high-speed logic signals), and scope probe connectors for measuring the high-speed data signals (logic and protocol signals).

The MXL1543 EV kit can evaluate the MAX3175 and is used in place of the MXL1544. Contact Maxim to order samples of the MAX3175CAI. No further changes are required to the board to evaluate the MAX3175.

### Features

- ◆ Programmable Transceiver Supports
  - V.28 (RS-232)
  - V.11 (RS-449/V.36, EIA530, EIA530-A, X.21)
  - V.35
- ◆ True Fail-Safe Receiver Inputs
- ◆ Certified TBR-1 and TBR-2 Compliant
- ◆ Certified NET1 and NET2 Compliant
- ◆ Programmable Cable Termination (MXL1344A)
- ◆ Fully Assembled and Tested

### Ordering Information

PART	TEMP RANGE	IC PACKAGE
MXL1543EVKIT	0°C to +70°C	28 SSOP (2), 24 SSOP

### Component List

DESIGNATION	QTY	DESCRIPTION
C1, C2, C5, C9-C13	8	1µF, 10V ceramic capacitors (0805) TDK C2012X5R1A105M
C3, C4	2	4.7µF, 10V ceramic capacitors (1206) TDK C3216X5R1A475M
C6, C7, C8	3	100pF ceramic capacitors (0603)
C14, C15	2	0.1µF ceramic capacitors (0603)
C16	1	0.1µF ceramic capacitor (0805)
C17	1	47µF, 16V tantalum capacitor (D case) AVX TPSD476M016R0200
R1, R2, R3	3	49.9Ω ±1% resistors (0805)
R4-R19	16	1.5kΩ ±5% resistors (0805)
D1-D6	6	Red LED
D7-D12	6	Green LED
D13-16	4	Yellow LED
U1	1	MXL1543CAI (28-pin SSOP)
U2	1	MXL1544CAI (28-pin SSOP)
U3	1	MXL1344ACAG (24-pin SSOP)
U4, U5	2	Inverting LED drivers (20-pin SO) TI SN74HC240DW or Motorola MC74HC240ADW

DESIGNATION	QTY	DESCRIPTION
RXD/TXD, RXC/SCTE, TXC/ N/A, N/A /TXC, SCTE/RXC, TXD/RXD, RXDA/TXDA, RXDB/TXDB, RXCA/SCTEA, RXCB/SCTEB, TXCA/TXCA, TXCB/TXCB, SCTEA/RXCA, SCTEB/RXCB, TXDA/RXDA, TXDB/RXDB	16	Scope probe connectors (top mount, 3.5mm ground cylinder) Tektronix 131-4244-00 (qty 100) 131-5031-00 (qty 25)
J1	1	40-pin header (2x20) 0.1in center
J2	1	DB25 right-angle female connector AMP AMP0012 747846-4
J3, J4, J5	3	SMA connectors (PC edge mount) EFJohnson 142-0701-801

Evaluates: MXL1543/MXL1544/MAX3175/MXL1344A



# MXL1543 Evaluation Kit

## Component List (continued)

DESIGNATION	QTY	DESCRIPTION
JU1–JU7	7	3-pin headers
JU8–JU17	10	2-pin headers
None	17	Shunts
None	1	MXL1543 EV kit PC board
None	1	MXL1543 EV kit data sheet
None	1	MXL1543 data sheet
None	1	MXL1544/MAX3175 data sheet
None	1	MXL1344A data sheet

## Quick Start

The MXL1543 EV kit is extremely flexible and has several settings for both the ICs as well as the board. The ICs have been put into no cable mode as the default mode. In no cable mode, the user is able to program the desired protocol with an external controller connected to the 40-pin header. The default mode settings are shown in Tables 1, 2, and 3. By default, the SMA connectors (J3, J4, and J5) are terminated with 50Ω and the MXL1544's transmitter input lines are all tied low.

- 1) Connect a single +5V, 5% power supply between VCC and GND located at the lower-left corner of the MXL1543 EV kit board.
- 2) The yellow LEDs indicate the protocol mode of the chipset. The LEDs light when the corresponding signal is a logic high. Verify that all yellow LEDs light up, indicating no cable mode. All board labels,

**Table 1. MXL1543 Default Mode**

MODE	M2	M1	M0	DCE/DTE	T1	T2	T3*	R1*	R2	R3
No Cable	1	1	1	1	Z	Z	Z	Z	Z	Z

Z = High impedance.

\*T3 and R1 share a single IC pin.

**Table 2. MXL1544/MAX3175 Default Mode**

MODE	M2	M1	M0	DCE/DTE	T1	T2	T3*	R1*	R2	R3	T4	R4
No Cable	1	1	1	1	Z	Z	Z	Z	Z	Z	Z	Z

Z = High impedance.

\*T3 and R1 share a single IC pin.

**Table 3. MXL1344A Default Mode**

MODE	M2	M1	M0	DCE/DTE	R1	R2	R3	R4	R5	R6	INVERT
No Cable	1	1	1	1	V.11	V.11	V.11	V.11	V.11	V.11	0

including all the labels for the LEDs, follow the same label format. The board label format is the top label corresponds to DCE mode and the bottom label corresponds to DTE mode.

- 3) The green LEDs are attached to the receiver logic outputs of the MXL1543 and MXL1544. The LEDs light when the receiver logic outputs are a logic high. Verify that all green LEDs light up when no signals are attached to the DB25 connector. **Note:** The receivers have the true fail-safe feature allowing zero volts differential voltage to be a valid state that forces the receiver outputs high.
- 4) The red LEDs are attached to the transmitter logic inputs of the MXL1543 and MXL1544. The LEDs light when the transmitter logic inputs are a logic high. Verify that none of the red LEDs light up when no signals are connected to the 40-pin header.

## Detailed Description

The MXL1543 EV kit was designed to take advantage of the chipset's flow-through pinout. The logic signals have all been routed to the 40-pin header located on the left side of the EV kit board and the protocol signals have all been routed to the female DB25 connector located on the right side of the board.

Various connectors have been added to the MXL1543 EV kit to aid in taking quality measurements. Leave JU17 unconnected when measuring the supply current of the chipset to eliminate the LED current. However, the supply current measurements still include the unloaded supply current of the LED driver ICs (up to

# MXL1543 Evaluation Kit

Evaluates: MXL1543/MXL1544/MAX3175/MXL1344A

**Table 4. MXL1543 Mode Selection**

MODE	M2	M1	M0	DCE/ DTE	T1	T2	T3*	R1*	R2	R3
Not Used (Default V.11)	0	0	0	0	V.11	V.11	Z	V.11	V.11	V.11
RS530A	0	0	1	0	V.11	V.11	Z	V.11	V.11	V.11
RS530	0	1	0	0	V.11	V.11	Z	V.11	V.11	V.11
X.21	0	1	1	0	V.11	V.11	Z	V.11	V.11	V.11
V.35	1	0	0	0	V.35	V.35	Z	V.35	V.35	V.35
RS449/V.36	1	0	1	0	V.11	V.11	Z	V.11	V.11	V.11
V.28/RS-232	1	1	0	0	V.28	V.28	Z	V.28	V.28	V.28
No Cable	1	1	1	0	Z	Z	Z	Z	Z	Z
Not Used (Default V.11)	0	0	0	1	V.11	V.11	V.11	Z	V.11	V.11
RS530A	0	0	1	1	V.11	V.11	V.11	Z	V.11	V.11
RS530	0	1	0	1	V.11	V.11	V.11	Z	V.11	V.11
X.21	0	1	1	1	V.11	V.11	V.11	Z	V.11	V.11
V.35	1	0	0	1	V.35	V.35	V.35	Z	V.35	V.35
RS449/V.36	1	0	1	1	V.11	V.11	V.11	Z	V.11	V.11
V.28/RS-232	1	1	0	1	V.28	V.28	V.28	Z	V.28	V.28
No Cable	1	1	1	1	Z	Z	Z	Z	Z	Z

Z = High impedance.  
\*T3 and R1 share a single IC pin.

160µA at +70°C). Scope probe connectors have been added to measure the high-speed signals of the transmitter inputs/outputs and receiver inputs/outputs of the MXL1543. The scope probe connectors located on the left side of the board are connected to the logic input and output signals. The scope probe connectors located on the right side of the board are connected to the protocol input and output signals. Three SMA connectors have also been provided for driving the high-speed transmitter inputs of the MXL1543. The row of 16 LEDs across the top of the board are logic indicators. The red LEDs indicate the state of the transmitter inputs of the MXL1543 and MXL1544. The green LEDs indicate the state of the receiver outputs of the MXL1543 and MXL1544. The yellow LEDs indicate the state of the protocol and the protocol termination modes. The LEDs light up when their corresponding signals are a logic high.

## Configuration

The following is a step-by-step procedure to aid in configuring the MXL1543 EV kit. The MXL1543 EV kit is extremely flexible and has several settings for both the

ICs, as well as the board. The logic signals have all been routed to the 40-pin header on the left side of the board. The protocol signals have all been routed to the female DB25 connector on the right side of the board.

The chipset protocol modes can be configured to support V.28 (RS-232), V.11 (RS-449/V.36, EIA530, EIA530-A, X.21), and V.35 protocols. All chipset logic inputs, LED power, and shield ground connection are jumper selectable. The board includes SMA connectors (J3, J4, and J5) with optional 50Ω termination. The board settings will be separated in the following sections: chipset protocol modes, clock/data transmitter input settings, control transmitter input settings, SMA termination, and power/ground:

- 1) Connect a single +5V 5% power supply between VCC and GND located at the lower-left corner of the MXL1543 EV kit board.
- 2) Chipset protocol modes:  
Select the desired chipset protocol mode using the MXL1543, MXL1544, and MXL1344A selection mode tables (Tables 4, 5, and 6). Connect the

# MXL1543 Evaluation Kit

**Evaluates: MXL1543/MXL1544/MAX3175/MXL1344A**

**Table 5. MXL1544/MAX3175 Mode Selection**

PROTOCOL	M2	M1	M0	DCE/ DTE	INVERT	T1	T2	T3*	R1*	R2	R3	T4*	R4*
Not Used (Default V.11)	0	0	0	0	0	V.11	V.11	Z	V.11	V.11	V.11	Z	V.10
RS-530A	0	0	1	0	0	V.11	V.10	Z	V.11	V.10	V.11	Z	V.10
RS-530	0	1	0	0	0	V.11	V.11	Z	V.11	V.11	V.11	Z	V.10
X.21	0	1	1	0	0	V.11	V.11	Z	V.11	V.11	V.11	Z	V.10
V.35	1	0	0	0	0	V.28	V.28	Z	V.28	V.28	V.28	Z	V.28
RS-449/V.36	1	0	1	0	0	V.11	V.11	Z	V.11	V.11	V.11	Z	V.10
V.28/RS-232	1	1	0	0	0	V.28	V.28	Z	V.28	V.28	V.28	Z	V.28
No Cable	1	1	1	0	0	Z	Z	Z	Z	Z	Z	Z	Z
Not Used (Default V.11)	0	0	0	0	1	V.11	V.11	Z	V.11	V.11	V.11	V.10	Z
RS-530A	0	0	1	0	1	V.11	V.10	Z	V.11	V.10	V.11	V.10	Z
RS-530	0	1	0	0	1	V.11	V.11	Z	V.11	V.11	V.11	V.10	Z
X.21	0	1	1	0	1	V.11	V.11	Z	V.11	V.11	V.11	V.10	Z
V.35	1	0	0	0	1	V.28	V.28	Z	V.28	V.28	V.28	V.28	Z
RS-449/V.36	1	0	1	0	1	V.11	V.11	Z	V.11	V.11	V.11	V.10	Z
V.28/RS-232	1	1	0	0	1	V.28	V.28	Z	V.28	V.28	V.28	V.28	Z
No Cable	1	1	1	0	1	Z	Z	Z	Z	Z	Z	Z	Z
Not Used (Default V.11)	0	0	0	1	0	V.11	V.11	V.11	Z	V.11	V.11	V.10	Z
RS-530A	0	0	1	1	0	V.11	V.10	V.11	Z	V.10	V.11	V.10	Z
RS-530	0	1	0	1	0	V.11	V.11	V.11	Z	V.11	V.11	V.10	Z
X.21	0	1	1	1	0	V.11	V.11	V.11	Z	V.11	V.11	V.10	Z
V.35	1	0	0	1	0	V.28	V.28	V.28	Z	V.28	V.28	V.28	Z
RS-449/V.36	1	0	1	1	0	V.11	V.11	V.11	Z	V.11	V.11	V.10	Z
V.28/RS-232	1	1	0	1	0	V.28	V.28	V.28	Z	V.28	V.28	V.28	Z
No Cable	1	1	1	1	0	Z	Z	Z	Z	Z	Z	Z	Z
Not Used (Default V.11)	0	0	0	1	1	V.11	V.11	V.11	Z	V.11	V.11	Z	V.10
RS-530A	0	0	1	1	1	V.11	V.10	V.11	Z	V.10	V.11	Z	V.10
RS-530	0	1	0	1	1	V.11	V.11	V.11	Z	V.11	V.11	Z	V.10
X.21	0	1	1	1	1	V.11	V.11	V.11	Z	V.11	V.11	Z	V.10
V.35	1	0	0	1	1	V.28	V.28	V.28	Z	V.28	V.28	Z	V.28
RS-449/V.36	1	0	1	1	1	V.11	V.11	V.11	Z	V.11	V.11	Z	V.10
V.28/RS-232	1	1	0	1	1	V.28	V.28	V.28	Z	V.28	V.28	Z	V.28
No Cable	1	1	1	1	1	Z	Z	Z	Z	Z	Z	Z	Z

Z = High impedance.

\*T3 and R1, and T4 and R4 share IC pins.

# MXL1543 Evaluation Kit

Evaluates: MXL1543/MXL1544/MAX3175/MXL1344A

**Table 6. MXL1344A Termination Mode Selection**

MODE	DCE/DTE	M2	M1	M0	R1	R2	R3	R4	R5	R6
Not Used (Default V.11)	0	0	0	0	Z	Z	Z	Z	Z	Z
RS530A	0	0	0	1	Z	Z	Z	V.11	V.11	V.11
RS530	0	0	1	0	Z	Z	Z	V.11	V.11	V.11
X.21	0	0	1	1	Z	Z	Z	V.11	V.11	V.11
V.35	0	1	0	0	V.35	V.35	Z	V.35	V.35	V.35
RS449/V.36	0	1	0	1	Z	Z	Z	V.11	V.11	V.11
V.28/RS232	0	1	1	0	Z	Z	Z	Z	Z	Z
No Cable	0	1	1	1	V.11	V.11	V.11	V.11	V.11	V.11
Not Used (Default V.11)	1	0	0	0	Z	Z	Z	Z	Z	Z
RS530A	1	0	0	1	Z	Z	Z	Z	V.11	V.11
RS530	1	0	1	0	Z	Z	Z	Z	V.11	V.11
X.21	1	0	1	1	Z	Z	Z	Z	V.11	V.11
V.35	1	1	0	0	V.35	V.35	V.35	Z	V.35	V.35
RS449/V.36	1	1	0	1	Z	Z	Z	Z	V.11	V.11
V.28/RS232	1	1	1	0	Z	Z	Z	Z	Z	Z
No Cable	1	1	1	1	V.11	V.11	V.11	V.11	V.11	V.11

Z = High impedance.

- jumpers to the corresponding state depending on whether the mode lines are controlled by an external controller or pin strapped to a known state using Tables 7 and 8. INVERT jumper defaults to logic low.
- 3) Clock/data transmitter input settings:  
Connect the clock/data jumpers to the corresponding state using Table 9. Force the inputs of all unused transmitters low so their corresponding LED indicators are off.
  - 4) Control transmitter input settings:  
Connect the control jumpers to the corresponding state using Table 10. Force the inputs of all unused transmitters low so their corresponding LED indicators are off.

- 5) SMA termination:  
Connect the termination jumpers, depending on whether the signal source needs to be terminated with 50Ω, to the corresponding state using Table 11. Leave unused transmitter input lines terminated so the line is pulled down in a known state. When using SMA termination, avoid connecting JU1, JU2, and JU3 to VCC.
- 6) Power/ground:  
Connect the power and ground jumpers according to the desired operation using Table 12.  
Leave JU17 unconnected (open) when measuring the supply current of the chipset.

# MXL1543 Evaluation Kit

Evaluates: MXL1543/MXL1544/MAX3175/MXL1344A

**Table 7. Chipset Protocol Mode Jumper Settings**

JUMPER	SIGNAL (BUS)	STATE	FUNCTION
JU13	DCE/ $\overline{DTE}$	Open*	Logic high (internal pullup in IC). DCE/ $\overline{DTE}$ line can be driven by a signal applied to J1-30 (40-pin header).
		Closed	Logic low.
JU14	M2	Open*	Logic high (internal pullup in IC). M2 line can be driven by a signal applied to J1-32 (40-pin header).
		Closed	Logic low.
JU15	M1	Open*	Logic high (internal pullup in IC). M1 line can be driven by a signal applied to J1-34 (40-pin header).
		Closed	Logic low.
JU16	M0	Open*	Logic high (internal pullup in IC). M0 line can be driven by a signal applied to J1-36 (40-pin header).
		Closed	Logic low.

\*Default jumper setting.

**Table 8. Invert Mode Jumper Settings**

JUMPER	SIGNAL	STATE	FUNCTION
JU12	INVERT	Open	Logic high (internal pullup in IC). INVERT can be driven by a signal applied to J1-38 (40-pin header).
		Closed*	Logic low.

\*Default jumper setting.

**Table 9. Clock/Data Transmitter Input Jumper Settings**

JUMPER	DCE/DTE	STATE	FUNCTION
JU1	RXD/TXD	1-2	Logic high.
		2-3	Logic low.
		Open*	Apply signal to SMA connector J5.
JU2	RXC/SCTE	1-2	Logic high.
		2-3	Logic low.
		Open*	Apply signal to SMA connector J4.
JU3	TXC/ N/A	1-2	Logic high.
		2-3	Logic low.
		Open*	Apply signal to SMA connector J3.

\*Default jumper setting.

# MXL1543 Evaluation Kit

Evaluates: MXL1543/MXL1544/MAX3175/MXL1344A

**Table 10. Control Transmitter Input Jumper Settings**

JUMPER	DCE/DTE	STATE	FUNCTION
JU4	CTS/RTS	1-2	Logic high.
		2-3*	Logic low.
		Open	Apply signal to J1-14 (40-pin header).
JU5	DSR/DTR	1-2	Logic high.
		2-3*	Logic low.
		Open	Apply signal to J1-16 (40-pin header).
JU6	DCD/ N/A	1-2	Logic high.
		2-3*	Logic low.
		Open	Apply signal to J1-18 (40-pin header).
JU7	LL/ N/A	1-2	Logic high.
		2-3*	Logic low.
		Open	Apply signal to J1-26 (40-pin header).

\*Default jumper setting.

**Table 11. Termination Settings**

JUMPER	DCE/DTE	STATE	FUNCTION
JU8	RXD/TXD	Open	Unterminated
		Closed*	Terminated with 50Ω
JU9	RXC/SCTE	Open	Unterminated
		Closed*	Terminated with 50Ω
JU10	TXC/ N/A	Open	Unterminated
		Closed*	Terminated with 50Ω

\*Default jumper setting.

**Table 12. Power/Ground Jumper Settings**

JUMPER	NAME	STATE	FUNCTION
JU11	SHIELD	Open	DB25 cable shield disconnected from signal ground.
		Closed*	DB25 cable shield shorted to signal ground.
JU17	LED ANODE	Open	LED anode is floating.
		Closed*	LED anode is connected to VCC.

\*Default jumper setting.

# MXL1543 Evaluation Kit

Evaluates: MXL1543/MXL1544/MXL1544/MAX3175/MXL1344A

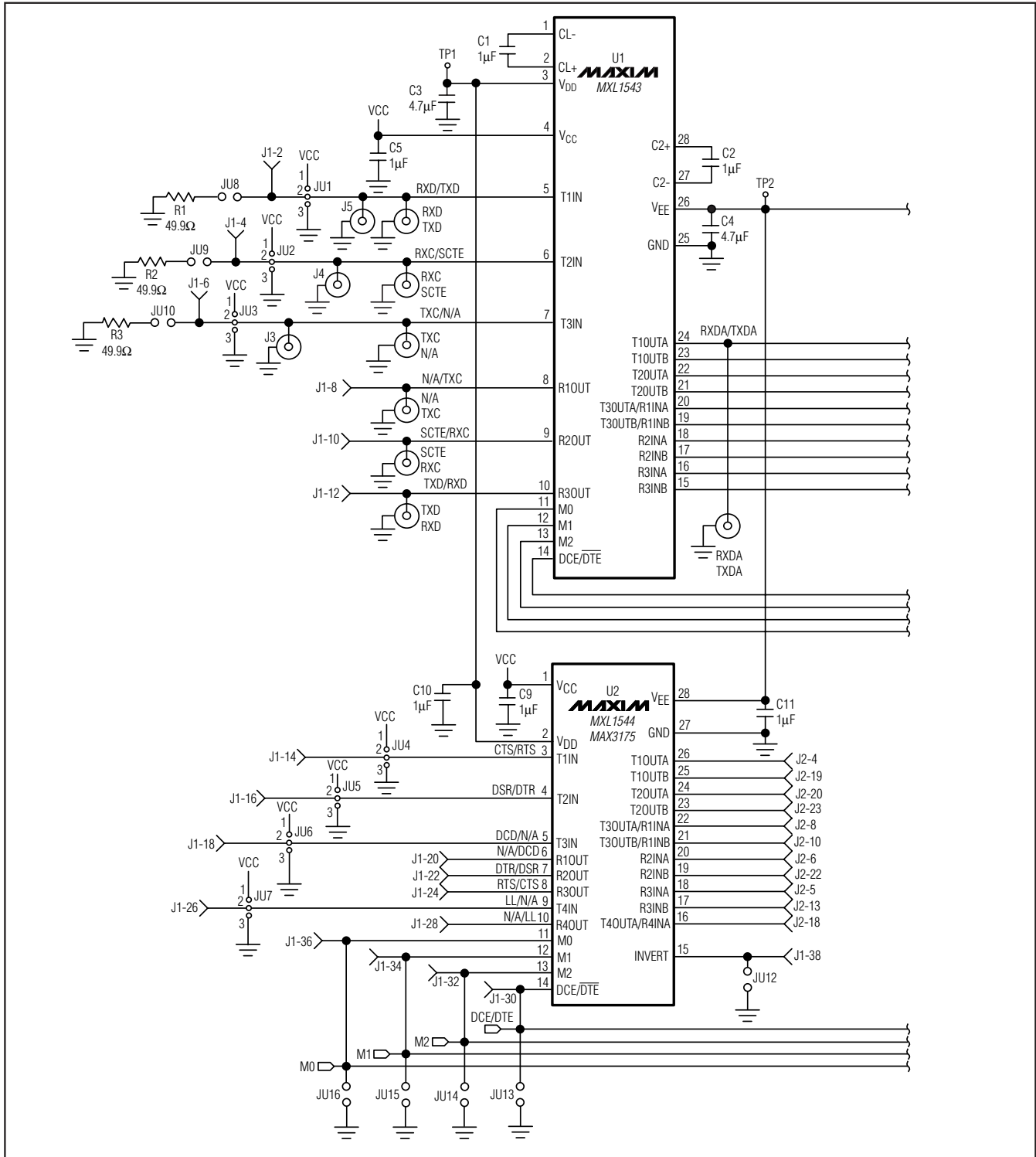

Figure 1a. MXL1543 EV Kit Schematic (Sheet 1 of 3)

# MXL1543 Evaluation Kit

Evaluates: MXL1543/MXL1544/MAX3175/MXL1344A

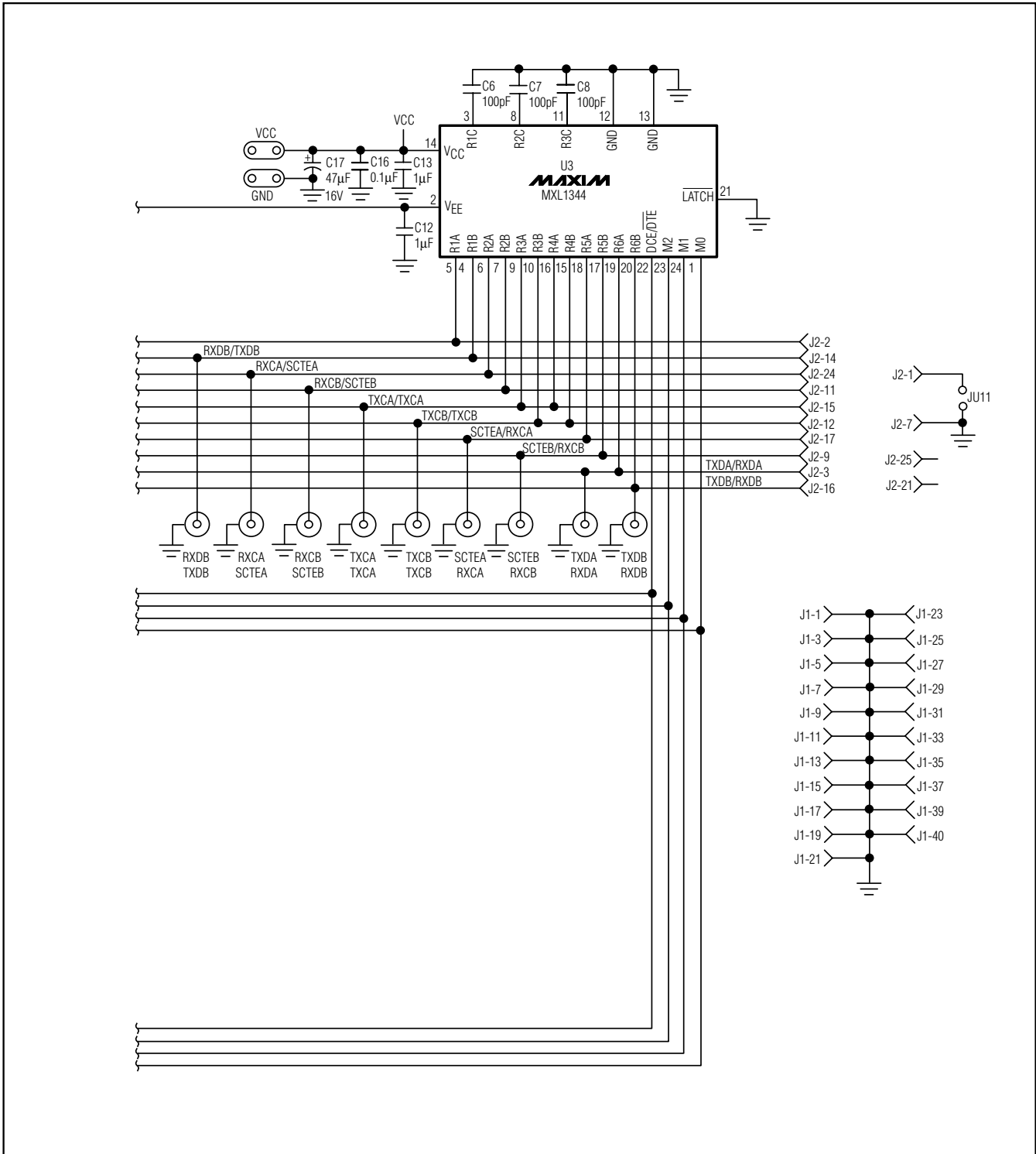

Figure 1a. MXL1543 EV Kit Schematic (Sheet 2 of 3)

# MXL1543 Evaluation Kit

**Evaluates: MXL1543/MXL1544/MAX3175/MXL1344A**

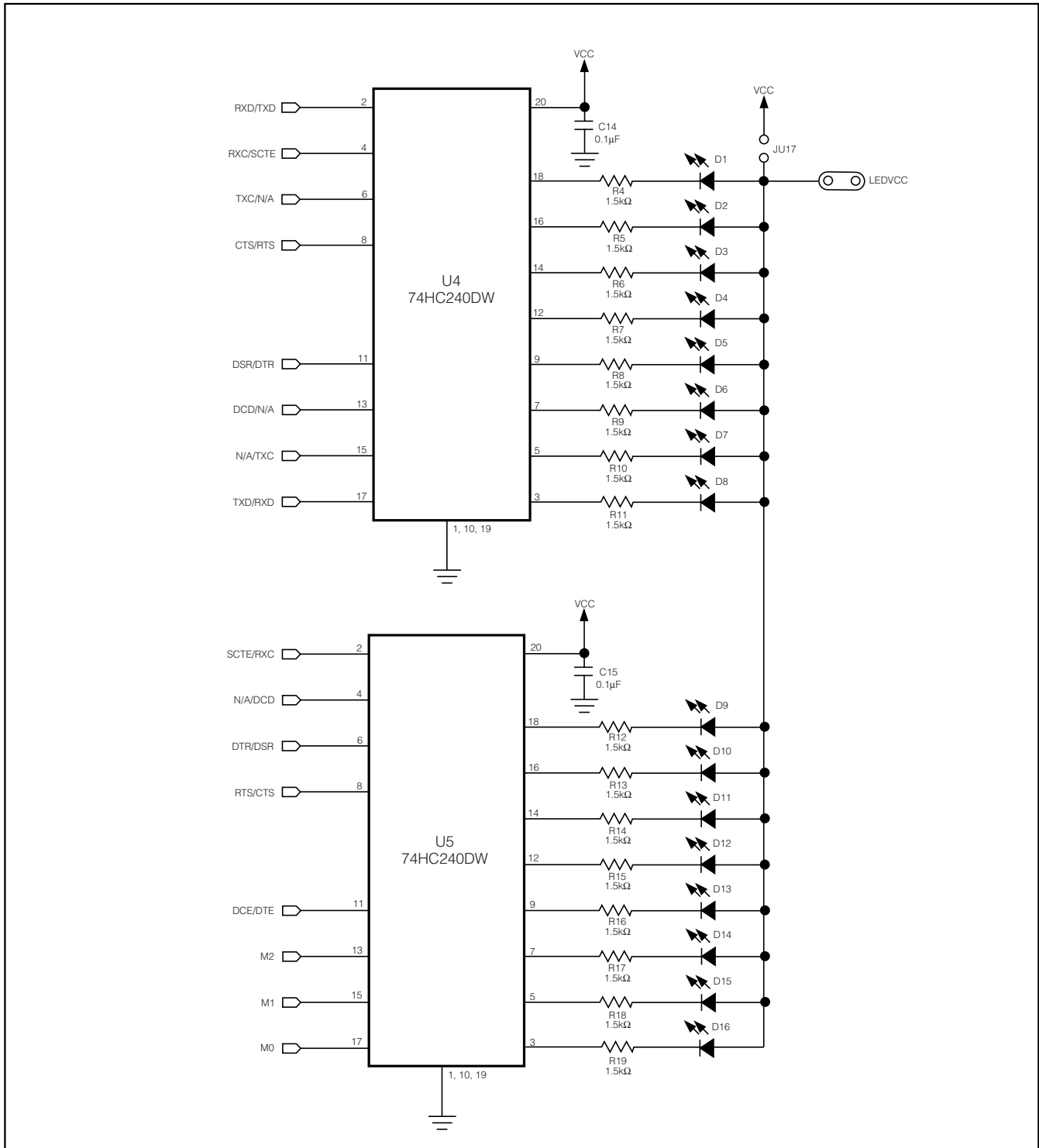

Figure 1b. MXL1543 EV Kit Schematic (Sheet 3 of 3)

# MXL1543 Evaluation Kit

Evaluates: MXL1543/MXL1544/MAX3175/MXL1344A

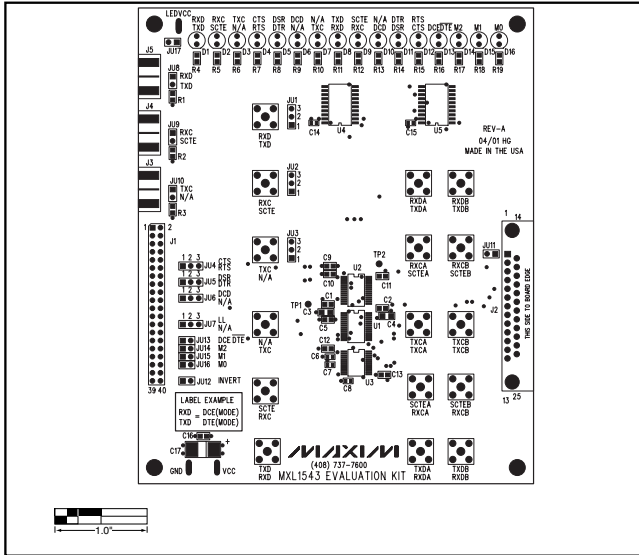

Figure 2. MXL1543 EV Kit Component Placement Guide—Component Side

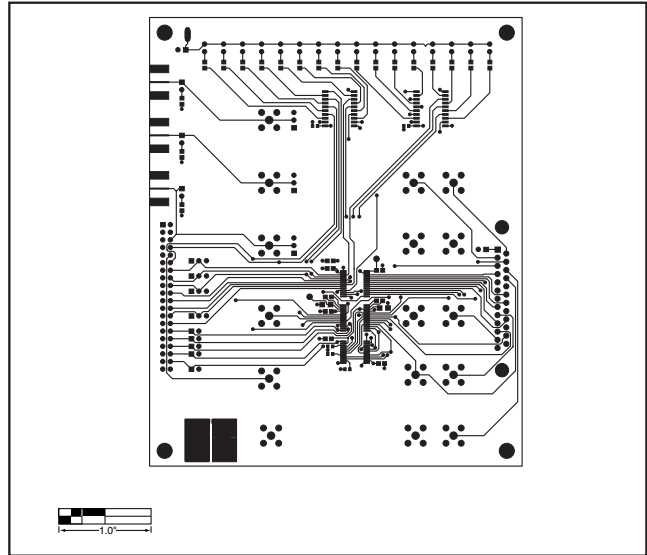

Figure 3. MXL1543 EV Kit PC Board Layout—Component Side

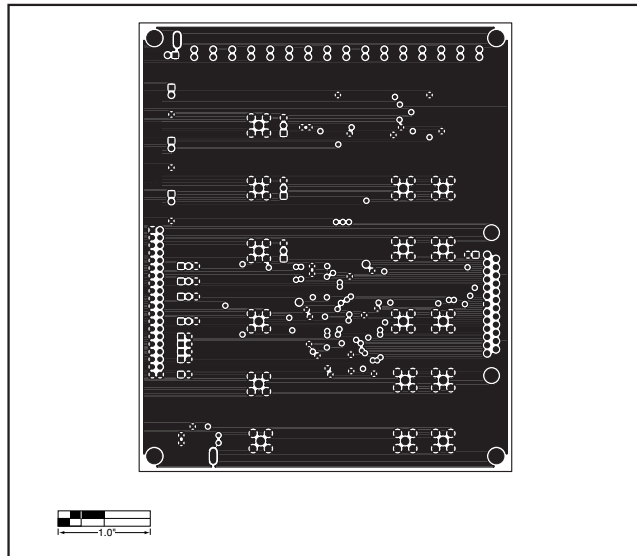

Figure 4. MXL1543 EV Kit PC Board Layout—Inner Layer 2 (GND)

# MXL1543 Evaluation Kit

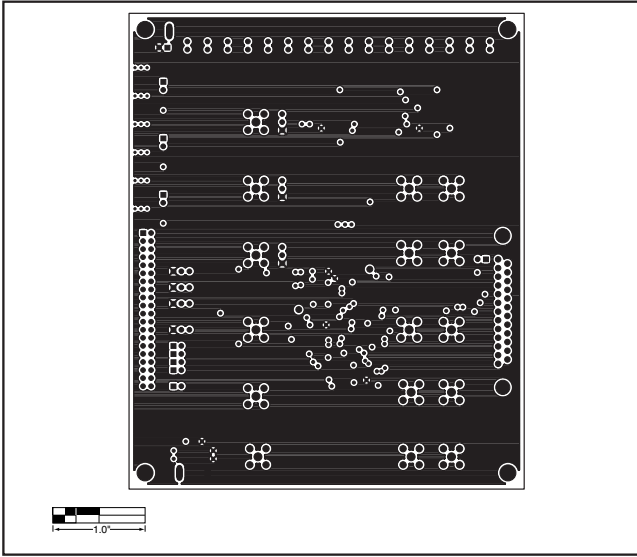

Figure 5. MXL1543 EV Kit PC Board Layout—Inner Layer 3 (VCC)

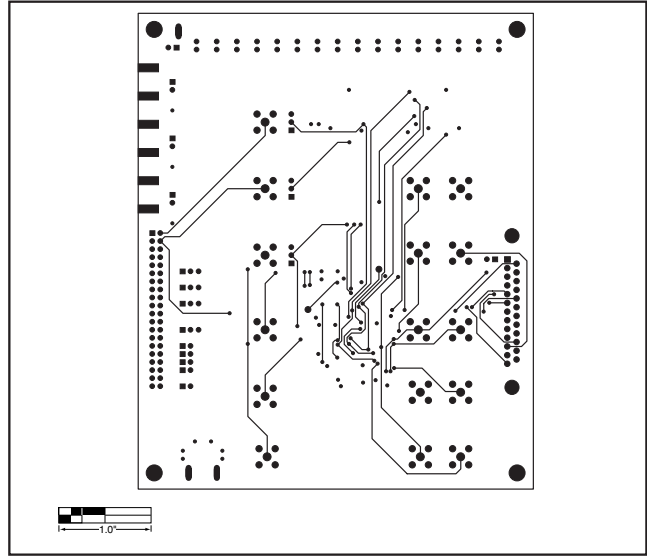

Figure 6. MXL1543 EV Kit PC Board Layout—Solder Side

Maxim cannot assume responsibility for use of any circuitry other than circuitry entirely embodied in a Maxim product. No circuit patent licenses are implied. Maxim reserves the right to change the circuitry and specifications without notice at any time.

12 \_\_\_\_\_ **Maxim Integrated Products, 120 San Gabriel Drive, Sunnyvale, CA 94086 408-737-7600**