



Dual-Flash-Pin Electronics/Supervoltage Switch Matrix

MAX9960

General Description

The MAX9960 dual-flash-pin electronics/supervoltage switch matrix replaces most of the relays and switches commonly needed to connect system resources to each of two pins in a flash memory or SOC ATE system (Figure 1). The device provides seven switches per channel to select up to four independent sources: the pin electronics (PE), two parametric measurement units (PMUs) or other Kelvin analog resources, and a flash memory programming supervoltage (FV_{HH}_). The force-and-sense PMU switches are independently controlled, enabling their use to connect two non-Kelvin resources in place of each PMU or Kelvin resource. Each MAX9960 contains two complete seven-switch channels with fully independent controls.

The MAX9960 features signal path switches with wide 600MHz bandwidth, low 3Ω series resistance, and low 8pF shunt capacitance over a voltage range compatible with common pin electronics ICs. An on-chip voltage-doubling buffer with selectable 1x or 2x gain generates the flash supervoltage, allowing a 6.5V DAC reference input to generate up to a maximum of 13V for flash-memory programming levels.

When switching from the FV_{HH}_ to PE_ or from PE_ to FV_{HH}_, the device-under-test (DUT_) voltage behaves monotonically. Switching transitions between the PE_ and FV_{HH}_ inputs are typically less than 350ns.

The MAX9960 operates over a commercial 0°C to +70°C temperature range, and is available in the 48-pin thin QFN package (7mm x 7mm x 0.8mm) with an exposed pad on the bottom for heat removal.

Applications

- Flash Memory Automatic Test Equipment
- SOC Automatic Test Equipment

Features

- ◆ Dual Supervoltage Switch Arrays
- ◆ 3Ω, 8pF, 600MHz Bandwidth Pin Electronics Paths
- ◆ 13V Flash Programming Paths
- ◆ On-Chip 1x and 2x Selectable Gains
- ◆ 2 Kelvin PMU Paths
- ◆ Fast Switching: 350ns (typ)
- ◆ Monotonic Slew Rate When Switching Between PE_ and FV_{HH}_

Ordering Information

PART	TEMP RANGE	PIN-PACKAGE*	PKG CODE
MAX9960BCTM	0°C to +70°C	48 Thin QFN-EP** (7mm x 7mm x 0.8mm)	T4877-6

*See full package information at the end of this data sheet.

**EP = Exposed pad.

Pin Configuration

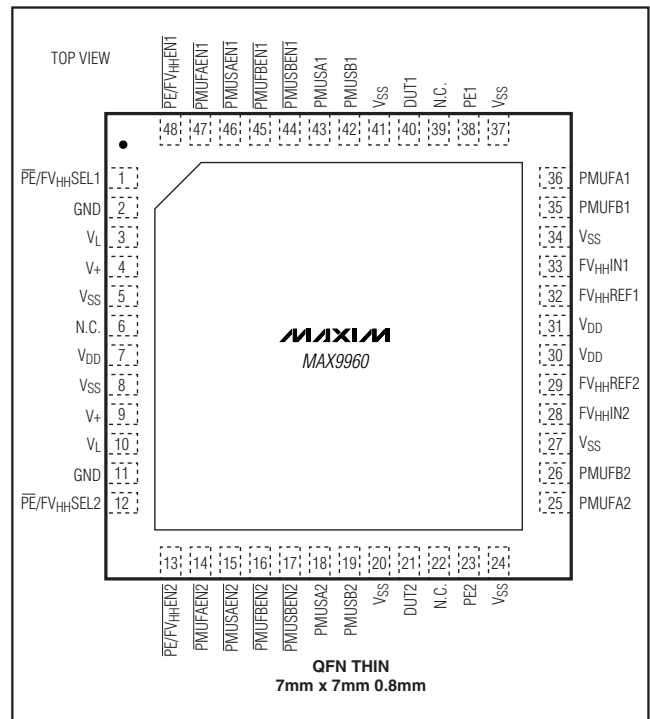

Dual-Flash-Pin Electronics/Supervoltage Switch Matrix

ABSOLUTE MAXIMUM RATINGS

V+ to GND	-0.3V to +26V
V _{DD} to GND	-0.3V to +16.5V
V _{SS} to GND	-6.5V to +0.3V
V _L to GND	-0.3V to +6V
V+ to V _{SS}	+32V
Digital Inputs	(GND - 0.3V) to (V _L + 0.3V)
FV _{HHIN}	(the higher of -4V and (V _{SS} - 0.3V)) to (the lower of +10V and (V _{DD} + 0.3V))
All Other Pins	(V _{SS} - 0.3V) to (V _{DD} + 0.3V)
Continuous Current, PE_	±120mA
Continuous Current, PMUS_	±10mA
Continuous Current, PMUFA_ + PMUFB_ + (FV _{HH} _ Path)	±45mA

Peak Current (100ns), PE_	±300mA
Peak Current (100ns), PMUS_	±20mA
Peak Current (100ns), PMUFA_ + PMUFB_ + (FV _{HH} _ Path)	±70mA
Package Continuous Power Dissipation (T _A = +70°C)	
48-Pin QFN-EP, on Single-Layer Board (derate 27.8mW/°C above +70°C)	2222mW
48-Pin QFN-EP, on Multilayer Board (derate 40.0mW/°C above +70°C)	3200mW
Operating Temperature Range	0°C to +70°C
Junction Temperature	+150°C
Storage Temperature Range	-65°C to +150°C
Lead Temperature (soldering 10s)	+300°C

Stresses beyond those listed under "Absolute Maximum Ratings" may cause permanent damage to the device. These are stress ratings only, and functional operation of the device at these or any other conditions beyond those indicated in the operational sections of the specifications is not implied. Exposure to absolute maximum rating conditions for extended periods may affect device reliability.

ELECTRICAL CHARACTERISTICS

(V+ = +24V, V_{DD} = +15V, V_{SS} = -5V, V_L = +3.3V, T_A = +25°C, unless otherwise noted. Specifications at T_A = 0°C and T_A = +70°C are guaranteed by design and characterization. Typical values are at T_A = +25°C, unless otherwise noted.) (Figure 1)

PARAMETER	SYMBOL	CONDITIONS	MIN	TYP	MAX	UNITS
DC CHARACTERISTICS						
PE_PATH						
On-Resistance	R _{ON}	V _{DUT} = +2.5V, I _{SW} = -40mA to +40mA, T _A = 0°C to +30°C (Note 1)	2.5	3.0	3.5	Ω
		V _{DUT} = +2.5V, I _{SW} = -40mA to +40mA, T _A = +30°C to +70°C (Note 1)	2.5		4.2	
On-Resistance Flatness	R _{FLAT(ON)}	V _{DUT} = 0 to +5V (Note 1)	-0.6		+0.6	Ω
Ch1 to Ch2 Resistance Match	R _{MATCH}	V _{DUT} = +2.5V, I _{SW} = -40mA to +40mA	-0.5		+0.5	Ω
Signal Voltage Range	V _{PE}		-3.5		+8.0	V
Operating DC Current Range	I _{SW}		-40		+40	mA
FV_{HH}_PATH						
On-Resistance	R _{ON}	FV _{HH} = -1.5V to (V _{DD} - 1.5V), I _{HH} = -10mA to +10mA (Notes 1, 2)	32		100	Ω
Operating Voltage Range	FV _{HH}		-1.5		V _{DD} - 1.5	V
Operating DC Current Range	I _{SW}		-10		+10	mA
FORCE PATHS						
On-Resistance	R _{ON}	V _{PMUF} = -4.25V to +14.5V, I _{PMUF} = -25mA to +25mA (Note 1)			70	Ω
Operating Voltage Range	V _{PMUF}		-4.25		+14.5	V
Operating DC Current Range	I _{SW}		-25		+25	mA
SENSE PATHS						
On-Resistance	R _{ON}	V _{PMUS} = -4.25V to +14.5V, I _{PMUS} = -1mA to +1mA (Note 1)			1250	Ω

Dual-Flash-Pin Electronics/Supervoltage Switch Matrix

MAX9960

ELECTRICAL CHARACTERISTICS (continued)

(V+ = +24V, VDD = +15V, VSS = -5V, VL = +3.3V, TA = +25°C, unless otherwise noted. Specifications at TA = 0°C and TA = +70°C are guaranteed by design and characterization. Typical values are at TA = +25°C, unless otherwise noted.) (Figure 1)

PARAMETER	SYMBOL	CONDITIONS	MIN	TYP	MAX	UNITS
Operating Voltage Range	VPMUS		-4.25		+14.5	V
Operating DC Current Range	ISW		-1		+1	mA
FVHH_ BUFFERS						
DC Output Current	I _{ODC}	FVHH = -1.5V to (VDD - 1.5V)	10			mA
Current Limit	I _{LIM}	DUT_ sourcing current	+15		+25	mA
		DUT_ sinking current	-25		-15	
Operating Voltage Range	FVHH	FVHHREF_ = 0 (Note 2)	-1.5		VDD - 1.5V	V
Linearity Error	LER_FVHH	FVHHREF_ = 0; no load; relative to 2-point line between VDUT_ = 0 and +13V; measured at VDUT_ = +3.25V, +6.5V, and +9.75V	-2		+2	mV
Gain	GFVHH	FVHHREF_ = 0, no load, VDUT_ = 0 to +13V (Note 3)	1.98	2.00	2.02	V/V
Output Offset	V _{OS_FVHH}	FVHHREF_ = 0, VDUT_ = +12V, no load	-50		+50	mV
Output Offset Temperature Coefficient	T _{C_VOS}	VDUT_ = 0 to +13V, FVHHREF_ = 0, TCASE = +30°C to +50°C		±0.2		mV/°C
Input Bias Current	IFVHH	FVHHIN_ = -1.5V to +7.5V, FVHHREF_ = open	-25		+25	μA
Gain Resistor Ground	FVHHREF	(Note 4)	-1.5		+0.5	V
Gain Resistor Current	I _{VHHREF}	Measured with FVHHIN_ = +5V, FVHHREF_ = 0		0.4		mA
LEAKAGE (Notes 5, 6)						
DUT_ Leakage, Disabled	I _{LEAK_OFF}	Switches S1, S2, S6, S7 open; VDUT_ = -4.25V to +14.5V	-1		+1	nA
PE_ Leakage	I _{LEAK_PE}	S1 closed; S2, S6, S7 open; VDUT_ = -3.5V to +8V	-1		+1	nA
PMUA_ Path Leakage, Enabled	I _{LEAK_PMU_A_ON}	S2, S4, S6 closed; S1, S3, S5, S7 open; VDUT_ = -4.25V to +14.5V	-1		+1	nA
PMUB_ Path Leakage, Enabled	I _{LEAK_PMU_B_ON}	S2, S5, S7 closed; S1, S3, S4, S6 open; VDUT_ = -4.25V to +14.5V	-1		+1	nA
PMUA_ Path Leakage, Disabled	I _{LEAK_PMU_A_OFF}	S4, S6 open; VPMUFA_ = -4.25V to +14.5V; measured at PMUFA_ with PMUSA_ externally connected to PMUFA_	-1		+1	nA
PMUB_ Path Leakage, Disabled	I _{LEAK_PMU_B_OFF}	S5, S7 open; VPMUFB_ = -4.25V to +14.5V; measured at PMUFB_ with PMUSB_ externally connected to PMUFB_	-1		+1	nA
DIGITAL INPUTS (PMUF_EN_, PMUS_EN_, PE/FVHHEN_, PE/FVHHSEL_)						
Input High Voltage	V _{IH}		+2.3			V
Input Low Voltage	V _{IL}				+0.4	V

Dual-Flash-Pin Electronics/Supervoltage Switch Matrix

ELECTRICAL CHARACTERISTICS (continued)

(V+ = +24V, V_{DD} = +15V, V_{SS} = -5V, V_L = +3.3V, T_A = +25°C, unless otherwise noted. Specifications at T_A = 0°C and T_A = +70°C are guaranteed by design and characterization. Typical values are at T_A = +25°C, unless otherwise noted.) (Figure 1)

PARAMETER	SYMBOL	CONDITIONS	MIN	TYP	MAX	UNITS
Input Voltage Range	V _{IN}		-0.2		V _L	V
Input Current	I _{IH} , I _{IL}	V _{IN} = -0.2V to V _L	-10		+10	μA
POWER SUPPLIES						
Positive Supply	V _{DD}		14.5	15	16.0	V
Negative Supply	V _{SS}		-6.00	-5	-4.25	V
High Voltage Supply	V+	(Note 1)	23	24	25	V
Logic Supply	V _L		3.0	3.3	3.6	V
Quiescent Positive Supply Current	Σ (I _{DD} , I ₊)	V+ = +24V, V _{DD} = +15V, V _{SS} = -5V, V _L = +3.3V, FV _{HH} I _N _ = +6.5V, FV _{HH} REF_ ₋ = 0, all digital inputs = +2.3V, no loads			10	mA
Quiescent Negative Supply Current	I _{SS}	V+ = +24V, V _{DD} = +15V, V _{SS} = -5V, V _L = +3.3V, FV _{HH} I _N _ = +6.5V, FV _{HH} REF_ ₋ = 0, all digital inputs = +2.3V, no loads			8.5	mA
Quiescent Logic Supply Current	I _{VL}	V+ = +24V, V _{DD} = +15V, V _{SS} = -5V, V _L = +3.3V, FV _{HH} I _N _ = +6.5V, FV _{HH} REF_ ₋ = 0, all digital inputs = +2.3V, no loads			2	mA
Quiescent Power Dissipation	P _{DQ}	V+ = +24V, V _{DD} = +15V, V _{SS} = -5V, V _L = +3.3V, FV _{HH} I _N _ = +6.5V, FV _{HH} REF_ ₋ = 0, all digital inputs = +2.3V, no loads			200	mW
AC CHARACTERISTICS						
SWITCHING TIMES BETWEEN PE_ AND FV_{HH}_ PATHS (Note 7) (Figure 3)						
Switch PE_ to FV _{HH} _	t _{ON_FVHH}	+5V to +7V transition		275	425	ns
		0 to +13V transition		350	500	
FV _{HH} _ Settling Time	t _{s_FVHH}	Settling to within larger of 1% step voltage or 50mV of final value		500		ns
Switch FV _{HH} _ to PE_	t _{ON_PE}			300	425	ns
PE_ Settling Time	t _{s_PE}	Settling to within larger of 1% step voltage or 50mV of final value		500		ns
PE_ to FV _{HH} _ Overshoot/Undershoot				±100		mV
PE_ to FV _{HH} _ Preshoot				±150		mV
Minimum Switching Slew Rate	SR _{MIN}	Over 20% to 80% region		±10		V/μs
SWITCHING TIMES, SAME PATH (Note 8) (Figure 2)						
PE_ Switch On-Time	t _{ON_1}	V _{PE} _ = +5V from 47Ω source		150		ns
FV _{HH} _ Switch On-Time	t _{ON_2,3}	FV _{HH} I _N _ = +2.5V, FV _{HH} REF_ ₋ = 0		350		ns

Dual-Flash-Pin Electronics/Supervoltage Switch Matrix

MAX9960

ELECTRICAL CHARACTERISTICS (continued)

(V+ = +24V, VDD = +15V, VSS = -5V, VL = +3.3V, TA = +25°C, unless otherwise noted. Specifications at TA = 0°C and TA = +70°C are guaranteed by design and characterization. Typical values are at TA = +25°C, unless otherwise noted.) (Figure 1)

PARAMETER	SYMBOL	CONDITIONS	MIN	TYP	MAX	UNITS
PMUF_ Switch On-Time	tON_2,4 tON_2,5	VPMUF_ = +5V		150		ns
PMUS_ Switch On-Time	tON_6 tON_7	VPMUS_ = +5V		300		ns
PE_, FVHH_, PMUF_ , PMUS_ Switch Off-Times	tOFF			700		ns
CAPACITANCE AND BANDWIDTH (Note 5)						
Capacitance, All Paths Disconnected	CDUT_OFF	All switches disconnected, for frequencies greater than 2MHz (Note 9)		20		pF
Capacitance, PE_ Path Connected (Note 9)	CDUT_PE	Switch S1 closed, all others open, for frequencies greater than 2MHz		8		pF
		Switch S1 closed, all others open, for frequencies less than 1kHz		50		
Unit-to-Unit Variation, PE_ Path Connected	ΔCDUT_PE	Switch S1 closed, all others open, for frequencies greater than 2MHz (Note 9)		±2		pF
Capacitance, PMUFA_ and PMUSA_ Path Connected	CDUT_PMUA	S2, S4, and S6 closed; all others open (Note 9)		35		pF
Capacitance, PMUFB_ and PMUSB_ Path Connected	CDUT_PMUB	S2, S5, and S7 closed; all others open (Note 9)		35		pF
Capacitance, PMUFA_ Path Disconnected	CPMUFA_OFF	S4 open, measured at PMUFA_ (Note 9)		10		pF
Capacitance, PMUFB_ Path Disconnected	CPMUFB_OFF	S5 open, measured at PMUFB_ (Note 9)		10		pF
Capacitance, PMUSA_ Path Connected	CPMUSA_ON	S6 closed, all others open, measured at PMUSA_ (Note 9)		10		pF
Capacitance, PMUSB_ Path Connected	CPMUSB_ON	S7 closed, all others open, measured at PMUSB_ (Note 9)		10		pF
Capacitance, PMUSA_ Path Disconnected	CPMUSA_OFF	S6 open, measured at PMUSA_ (Note 9)		5		pF
Capacitance, PMUSB_ Path Disconnected	CPMUSB_OFF	S7 open, measured at PMUSB_ (Note 9)		5		pF
PE_ Signal Bandwidth	f3DB	Only PE_ path enabled (Note 10)		600		MHz
FVHH_ BUFFER						
Slew Rate	SRFVHH	FVHHREF_ = 0, (gain = 2), FVHHIN_ stepped from 0 to +5V and +5V to 0		±5		V/μs
Settling	ts	CDUT_ = 200pF to within 0.1% of step voltage, after FVHHIN_ changes		25		μs
		CDUT_ = 4000pF to within 0.1% of step voltage, after FVHHIN_ changes (Note 11)		50		

Dual-Flash-Pin Electronics/Supervoltage Switch Matrix

ELECTRICAL CHARACTERISTICS (continued)

($V_+ = +24V$, $V_{DD} = +15V$, $V_{SS} = -5V$, $V_L = +3.3V$, $T_A = +25^\circ C$, unless otherwise noted. Specifications at $T_A = 0^\circ C$ and $T_A = +70^\circ C$ are guaranteed by design and characterization. Typical values are at $T_A = +25^\circ C$, unless otherwise noted.) (Figure 1)

- Note 1:** V_+ should be at least 8V above V_{DD} to guarantee specified path resistance values.
- Note 2:** When the $FV_{HH_}$ buffer is configured for a gain of +1 ($FV_{HHREF_}$ open), the output voltage range is limited to -1.5V to +7.5V.
- Note 3:** $FV_{HH_}$ buffer gain is typically +1, when $FV_{HHREF_}$ is open.
- Note 4:** $FV_{HHREF_}$ is tested by repeating the $FV_{HH_}$ path resistance tests over the variation of $FV_{HHREF_}$. For each value of $FV_{HHREF_}$, $FV_{HHIN_}$ is adjusted to $FV_{HHIN_} = (FV_{HH_} + FV_{HHREF_}) / 2$.
- Note 5:** All measurements taken at $DUT_$, except where noted.
- Note 6:** These specifications are guaranteed by design and characterization. In addition, these specifications will be production tested with min/max test limits of $\pm 10nA$.
- Note 7:** Voltage source driving $PE_$ has 47Ω source resistance. $PE_ = 0$ to +5.0V, $FV_{HH_} = +7$ to +13V. Measured from 50% point of input logic to 90% of analog swing.
- Note 8:** All unused switches open, unless otherwise noted. Measured from 50% point of input logic to 90% of analog swing.
- Note 9:** Unless otherwise noted, measured at $DUT_$. No external connections to any of the switched analog pins— $PE_$, $DUT_$, $PMUFA_$, $PMUFB_$, $PMUSA_$, or $PMUSB_$ —except as needed to make measurement.
- Note 10:** $Z_{DUT_} = 50\Omega$; equivalent bandwidth calculated from measured $DUT_$ rise and fall time with $PE_$ stimulated by a 3V step with 1ns 10% to 90% rise/fall time.
- Note 11:** The maximum load for FV_{HH} buffer is 4000pF.

Typical Operating Characteristics

($V_+ = +24V$, $V_{DD} = +15V$, $V_{SS} = -5V$, $V_L = +3.3V$, $T_A = +25^\circ C$, unless otherwise noted.)

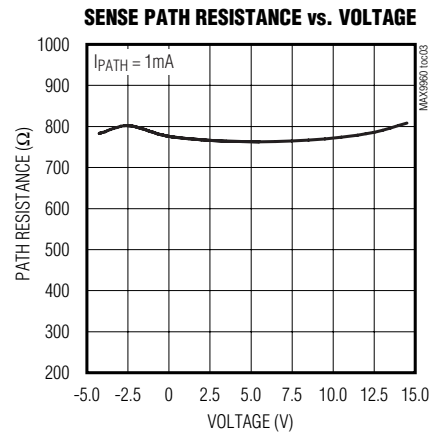
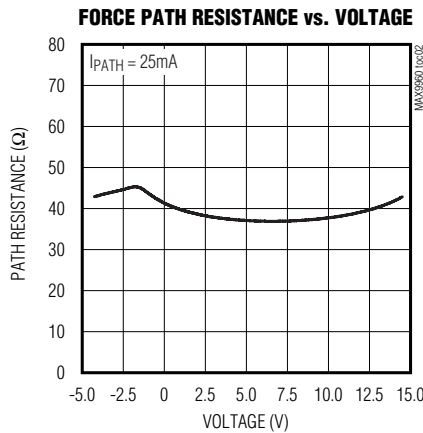
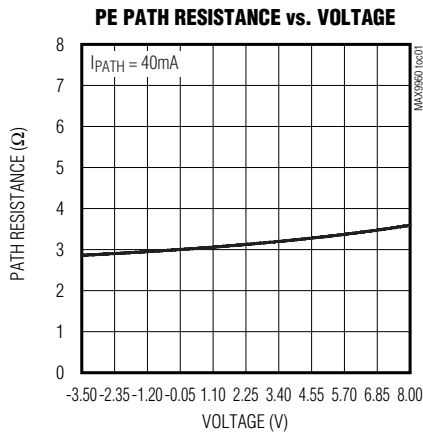

Dual-Flash-Pin Electronics/Supervoltage Switch Matrix

MAX9960

Typical Operating Characteristics (continued)

($V_+ = +24V$, $V_{DD} = +15V$, $V_{SS} = -5V$, $V_L = +3.3V$, $T_A = +25^\circ C$, unless otherwise noted.)

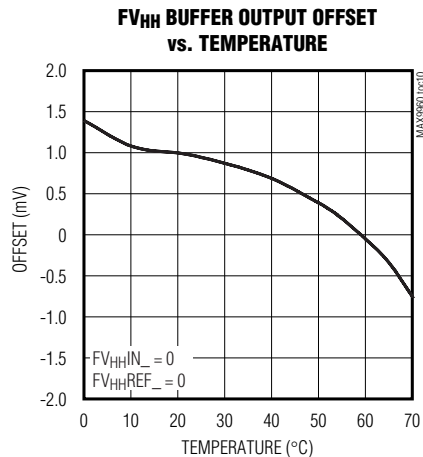
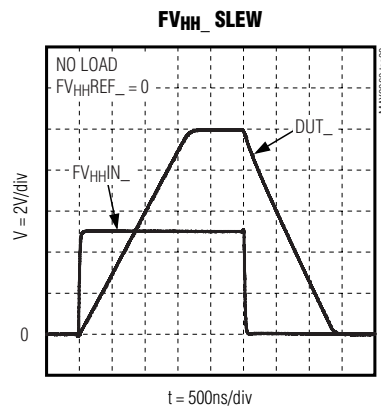
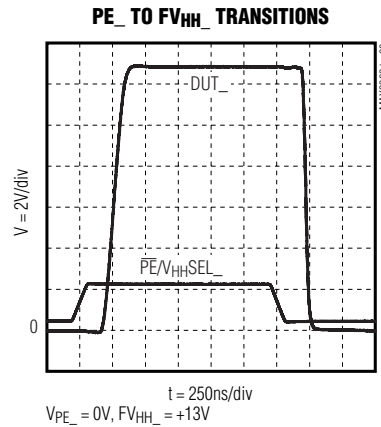
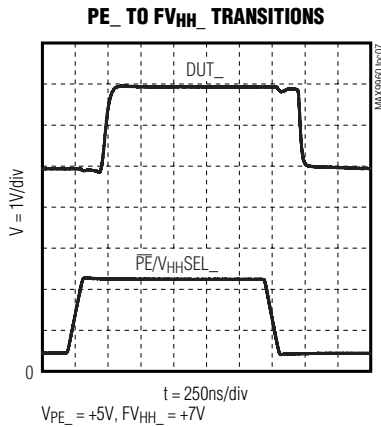
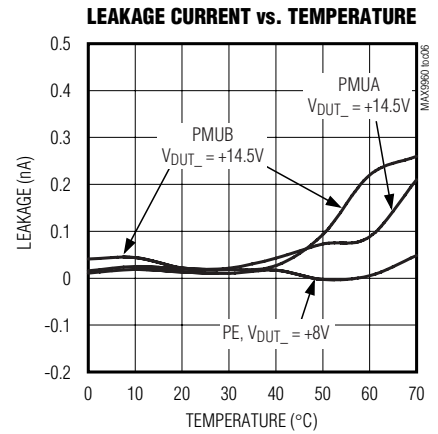
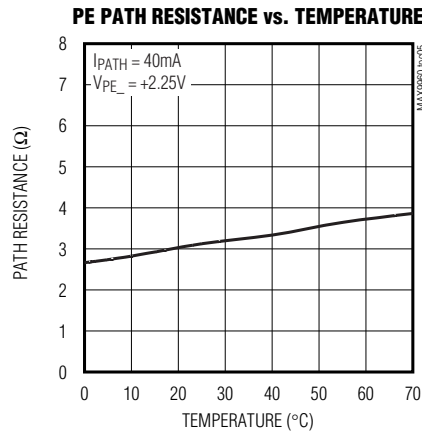
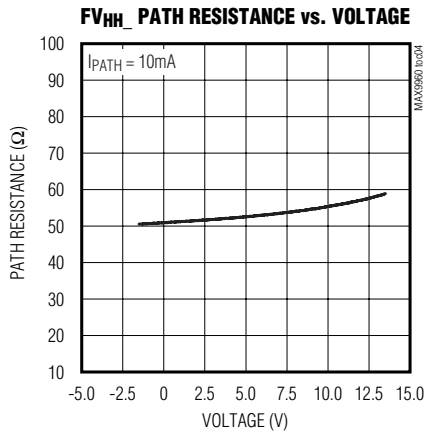

Dual-Flash-Pin Electronics/Supervoltage Switch Matrix

Pin Description

PIN	NAME	FUNCTION
1	$\overline{\text{PE}}/\text{FV}_{\text{HH}}\text{SEL1}$	PE1 or $\text{FV}_{\text{HH}}1$ Select. Selects either PE1 or $\text{FV}_{\text{HH}}1$ to be connected to DUT1. Force low to select PE1, force high to select $\text{FV}_{\text{HH}}1$.
2, 11	GND	Ground
3, 10	V_L	Logic Power Supply. Nominally 3.3V.
4, 9	V_+	Analog Positive Gate-Drive Power Supply. Nominally 24V.
5, 8, 20, 24, 27, 34, 37, 41	V_{SS}	Analog Negative Power Supply. Nominally -5V.
6, 22, 39	N.C.	No Connection. Make no connection to this pin.
7, 30, 31	V_{DD}	Analog Positive Power Supply. Nominally 15V.
12	$\overline{\text{PE}}/\text{FV}_{\text{HH}}\text{SEL2}$	PE2 or $\text{FV}_{\text{HH}}2$ Select. Selects either PE2 or $\text{FV}_{\text{HH}}2$ to be connected to DUT2. Force low to select PE2, force high to select $\text{FV}_{\text{HH}}2$.
13	$\overline{\text{PE}}/\text{FV}_{\text{HH}}\text{EN2}$	PE2 and $\text{FV}_{\text{HH}}2$ Enable. Enables PE2 and $\text{FV}_{\text{HH}}2$ to be connected to DUT2, as determined by $\overline{\text{PE}}/\text{FV}_{\text{HH}}\text{SEL2}$. Force low to enable signal path, force high to disable the signal path.
14	$\overline{\text{PMUFA}}\text{EN2}$	PMUFA2 Enable. Controls the connection of PMUFA2 to DUT2. Force low to connect PMUFA2 to DUT2, force high to disconnect PMUFA2 from DUT2.
15	$\overline{\text{PMUSA}}\text{EN2}$	PMUSA2 Enable. Controls the connection of PMUSA2 to DUT2. Force low to connect PMUSA2 to DUT2, force high to disconnect PMUSA2 from DUT2.
16	$\overline{\text{PMUFB}}\text{EN2}$	PMUFB2 Enable. Controls the connection of PMUFB2 to DUT2. Force low to connect PMUFB2 to DUT2, force high to disconnect PMUFB2 from DUT2.
17	$\overline{\text{PMUSB}}\text{EN2}$	PMUSB2 Enable. Controls the connection of PMUSB2 to DUT2. Force low to connect PMUSB2 to DUT2, force high to disconnect PMUSB2 from DUT2.
18	PMUSA2	Sense A Analog Output for Channel 2. Kelvin feedback output for the channel 2 force A path.
19	PMUSB2	Sense B Analog Output for Channel 2. Kelvin feedback output for the channel 2 force B path.
21	DUT2	Analog I/O for Channel 2. Connects to the DUT.
23	PE2	Analog I/O for Channel 2. Connects to the pin electronics I/O.
25	PMUFA2	Analog Input Force A for Channel 2. Connects to an external DC resource such as a PMU.
26	PMUFB2	Analog Input Force B for Channel 2. Connects to an external DC resource such as a PMU.
28	$\text{FV}_{\text{HH}}\text{IN2}$	Analog Supervoltage Input for Channel 2. The voltage applied to $\text{FV}_{\text{HH}}\text{IN2}$ is amplified as determined by $\text{FV}_{\text{HH}}\text{REF2}$ (see the <i>Functional Block Diagram</i>).
29	$\text{FV}_{\text{HH}}\text{REF2}$	Analog Gain-Setting Input for Channel 2. Sets the gain of the $\text{FV}_{\text{HH}}2$ buffer.
32	$\text{FV}_{\text{HH}}\text{REF1}$	Analog Gain-Setting Input for Channel 1. Sets the gain of the $\text{FV}_{\text{HH}}1$ buffer.
33	$\text{FV}_{\text{HH}}\text{IN1}$	Analog Supervoltage Input for Channel 1. The voltage applied to $\text{FV}_{\text{HH}}\text{IN1}$ is amplified as determined by $\text{FV}_{\text{HH}}\text{REF1}$ (see the <i>Functional Block Diagram</i>).
35	PMUFB1	Analog Input Force B for Channel 1. Connects to an external DC resource such as a PMU.
36	PMUFA1	Analog Input Force A for Channel 1. Connects to an external DC resource such as a PMU.
38	PE1	Analog I/O for Channel 1. Connects to the pin electronics I/O.
40	DUT1	Analog I/O for Channel 1. Connects to the DUT.
42	PMUSB1	Sense B Analog Output for Channel 1. Kelvin feedback output for the channel 1 force B path.
43	PMUSA1	Sense A Analog Output for Channel 1. Kelvin feedback output for the channel 1 force A path.

Dual-Flash-Pin Electronics/Supervoltage Switch Matrix

MAX9960

Pin Description (continued)

PIN	NAME	FUNCTION
44	$\overline{\text{PMUSBEN1}}$	PMUSB1 Enable. Controls the connection of PMUSB1 to DUT1. Force low to connect PMUSB1 to DUT1, force high to disconnect PMUSB1 from DUT1.
45	$\overline{\text{PMUFBEN1}}$	PMUFB1 Enable. Controls the connection of PMUFB1 to DUT1. Force low to connect PMUFB1 to DUT1, force high to disconnect PMUFB1 from DUT1.
46	$\overline{\text{PMUSAEN1}}$	PMUSA1 Enable. Controls the connection of PMUSA1 to DUT1. Force low to connect PMUSA1 to DUT1, force high to disconnect PMUSA1 from DUT1.
47	$\overline{\text{PMUFAEN1}}$	PMUFA1 Enable. Controls the connection of PMUFA1 to DUT1. Force low to connect PMUFA1 to DUT1, force high to disconnect PMUFA1 from DUT1.
48	$\overline{\text{PE/FVHHEN1}}$	PE1 and FVHH1 Enable. Enables PE1 and FVHH1 to be connected to DUT1, as determined by $\overline{\text{PE/FVHHSEL1}}$. Force low to enable signal path, force high to disable the signal path.
—	EP	Exposed Pad for Heat Removal. Internally biased to VSS. Connect to VSS or leave floating.

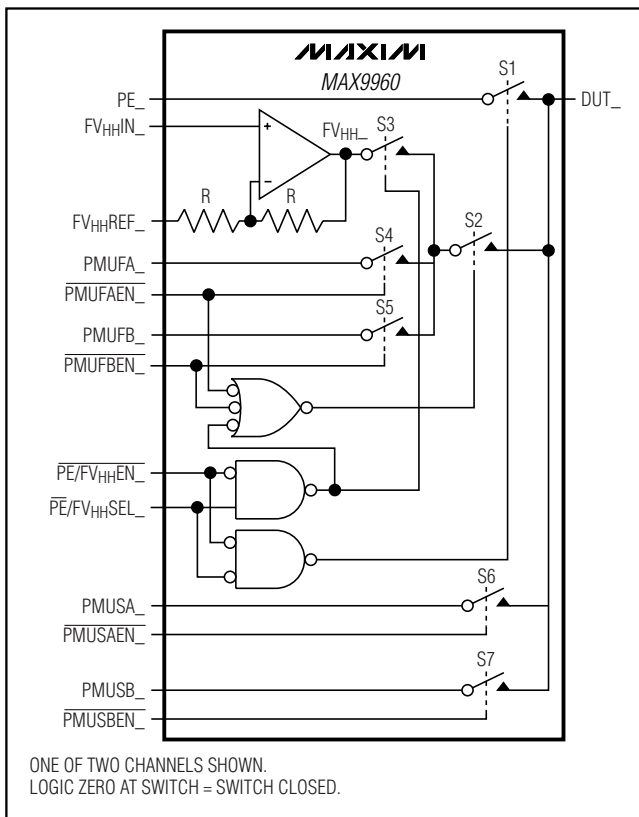

Figure 1. Functional Block Diagram

Detailed Description

The MAX9960 is a dual analog switch matrix featuring two Kelvin PMU paths, a PE path, and a flash programming supervoltage circuit that allows testing of flash memory using standard PE devices. It makes possible, without the use of relays, a fully functional pin with both AC and DC capabilities.

The signal path switches feature 600MHz bandwidth, 3Ω series resistance, and 8pF shunt capacitance over a voltage range compatible with common pin-electronics ICs. The voltage-doubling buffer, with selectable 1x or 2x gain, generates the 13V flash memory programming level from a 6.5V input. Configure the switches using digital inputs $\overline{\text{PMUFAEN1}}$, $\overline{\text{PMUSAEN1}}$, $\overline{\text{PMUFBEN1}}$, $\overline{\text{PMUSBEN1}}$, $\overline{\text{PE/FVHHEN1}}$, and $\overline{\text{PE/FVHHSEL1}}$ as indicated in Tables 1 and 2.

The switching speed between PE_ and FVHH_ paths is less than 350ns typical (Figure 3), and during switching, DUT_ behaves monotonically.

FVHH Buffer Load Capacitance

The maximum load capacitance for the FVHH buffer is 4000pF. While this amount of load capacitance is not expected during normal operation, an application may call for the buffer to be connected to a highly capacitive PMU path occasionally for calibration purposes. No damage to the MAX9960 will result as a consequence of this condition.

Supervoltage FVHH Buffer Gain

The FVHH buffer gain can be selected using FVHHREF_. If FVHHREF_ is grounded, the gain of the buffer is +2. If FVHHREF_ is left floating, the buffer gain is +1.

Dual-Flash-Pin Electronics/Supervoltage Switch Matrix

Table 1. Switch Control, All Possible Combinations

PMUFAEN ₋	PMUFBEN ₋	PMUSAEN ₋	PMUSBEN ₋	PE/FV _{HH} EN ₋	PE/FV _{HH} SEL ₋	DUT ₋
0	X	X	X	X	X	PMUFA ₋ path connected
X	0	X	X	X	X	PMUFB ₋ path connected
X	X	0	X	X	X	PMUSA ₋ path connected
X	X	X	0	X	X	PMUSB ₋ path connected
X	X	X	X	0	1	FV _{HH} ₋ path connected
X	X	X	X	0	0	PE ₋ path connected
All other combinations						Every path is disconnected

Table 2. Switch Control, Use Cases

PMUFAEN ₋	PMUFBEN ₋	PMUSAEN ₋	PMUSBEN ₋	PE/FV _{HH} EN ₋	PE/FV _{HH} SEL ₋	DUT ₋
1	1	1	1	0	0	PE ₋
1	1	1	1	0	1	FV _{HH} ₋
0	1	0	1	1	X	PMUFA ₋ + PMUSA ₋
1	0	1	0	1	X	PMUFB ₋ + PMUSB ₋
0	1	0	1	0	0	PE ₋ + PMUFA ₋ + PMUSA ₋
1	0	1	0	0	0	PE ₋ + PMUFB ₋ + PMUSB ₋
0	1	0	1	0	1	FV _{HH} ₋ + PMUFA ₋ + PMUSA ₋
1	0	1	0	0	1	FV _{HH} ₋ + PMUFB ₋ + PMUSB ₋
0	0	0	0	0	0	PE ₋ + PMUFA ₋ + PMUSA ₋ + PMUFB ₋ + PMUSB ₋

Power-Supply Considerations

The MAX9960 requires four power-supply voltages, typically V₊ = +24V, V_{DD} = +15V, V_{SS} = -5V, and V_L = +3.3V. Use a 0.1µF bypass capacitor close to each supply pin, and provide bulk bypassing where power enters the circuit board. The MAX9960 does not require any special power-up sequencing.

Chip Information

TRANSISTOR COUNT: 2020

PROCESS: BiCMOS

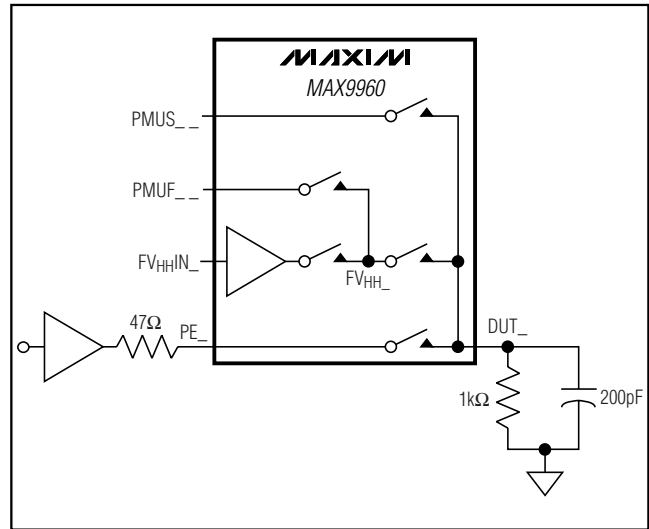

Figure 2. Switching Time Test Circuit

Dual-Flash-Pin Electronics/Supervoltage Switch Matrix

MAX9960

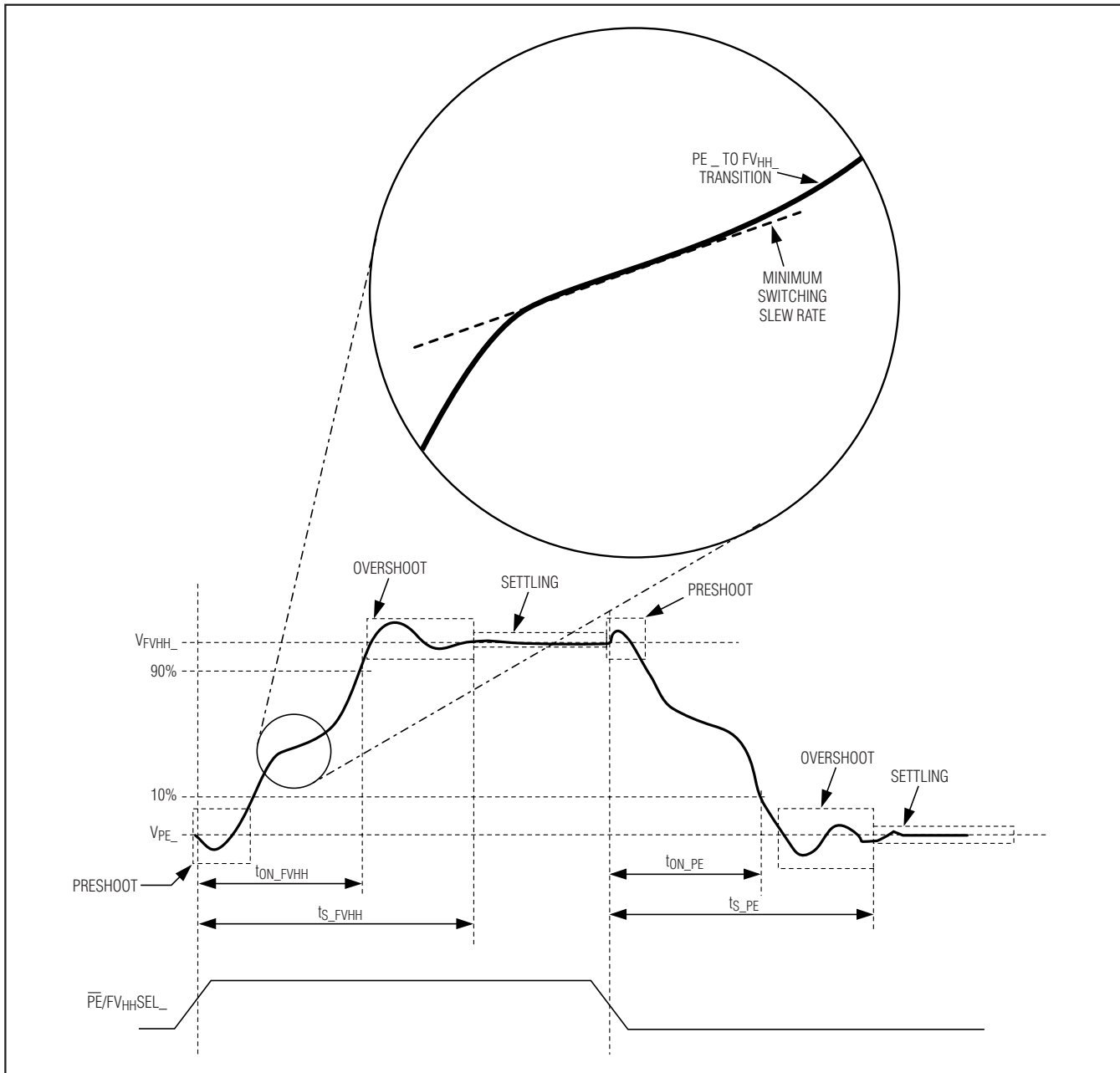

Figure 3. PE_ - FVHH_ and FVHH_ - PE_ Transition and Settling Timing

Package Information

For the latest package outline information, go to www.maxim-ic.com/packages.

Maxim cannot assume responsibility for use of any circuitry other than circuitry entirely embodied in a Maxim product. No circuit patent licenses are implied. Maxim reserves the right to change the circuitry and specifications without notice at any time.

Maxim Integrated Products, 120 San Gabriel Drive, Sunnyvale, CA 94086 408-737-7600 11