



MAX9597 Evaluation Kit

General Description

The MAX9597 evaluation kit (EV kit) is an assembled and tested PCB used to evaluate the MAX9597 single SCART interface. It routes audio, video, and control signals between a set-top box decoder chip and the TV SCART connector. The on-board microcontroller, which is connected to the PC through the universal serial bus (USB) port, acts as the I²C master.

The EV kit also includes Windows® 2000/XP/Vista®-compatible software that provides a simple user interface for exercising the features of the MAX9597. The program is menu driven and offers a graphical user interface (GUI) complete with control buttons. The EV kit comes with the MAX9597CTI+ installed.

Features

- ◆ Windows 2000/XP/Vista (32-Bit)-Compatible Software
- ◆ TV SCART Connector
- ◆ On-Board Microcontroller to Generate I²C Commands
- ◆ Easy-to-Use, Menu-Driven Software
- ◆ USB-PC Connection (Cable Included)
- ◆ Lead-Free and RoHS Compliant

Ordering Information

PART	TYPE
MAX9597EVKIT+	EV Kit

+Denotes lead-free and RoHS compliant.

Component List

DESIGNATION	QTY	DESCRIPTION
C1, C12, C14, C31, C32, C36, C43, C51	8	10 μ F \pm 10%, 16V X5R ceramic capacitors (0805) Murata GRM21BR61C106K
C2, C3	2	22pF \pm 5%, 50V C0G ceramic capacitors (0603) Murata GRM1885C1H220J
C4	1	0.033 μ F \pm 10%, 25V X7R ceramic capacitor (0603) TDK C1608X7R1E333K
C5–C10, C17–C28, C33, C34, C37–C42	26	0.1 μ F \pm 10%, 16V X7R ceramic capacitors (0603) TDK C1608X7R1C104K
C11, C13, C29, C30	4	1 μ F \pm 10%, 16V X5R ceramic capacitors (0603) TDK C1608X5R1C105K
C15, C16	2	10pF \pm 5%, 50V C0G ceramic capacitors (0603) Murata GRM1885C1H100J
C35, C44–C50	0	Not installed, capacitors (0603)
D1–D8	8	100V/200mA ultra-fast diodes (SOT23) Central Semiconductor CMPD7000 LEAD FREE
ENC_B_IN, ENC_G_IN, ENC_R/C_IN, ENC_Y/CVBS_IN	4	75 Ω BNC female jacks, 4-pin, 0.25in spacing (top mount)

DESIGNATION	QTY	DESCRIPTION
H1	0	Not installed, 2 x 5-pin JTAG header
JU1	1	5-pin header
JU2, JU3, JU4	3	3-pin headers
L1	1	Ferrite bead (0603) TDK MMZ1608R301A
P1	1	USB type-B right-angle PC-mount receptacle
P2	1	SCART connector (side-entry PCB mount) KYCON K-SCARTX-021
P3, P4, P5	3	RCA phono jacks (side-entry PCB mount), white
P6, P7, P8	3	RCA phono jacks (side-entry PCB mount), red
R1, R2	2	27 Ω \pm 5% resistors (0603)
R3, R22, R23	3	1.5k Ω \pm 5% resistors (0603)
R4	1	470 Ω \pm 5% resistor (0603)
R5	1	2.2k Ω \pm 5% resistor (0603)
R6, R36, R42	3	10k Ω \pm 5% resistors (0603)
R7	1	169k Ω \pm 1% resistor (0603)
R8	1	100k Ω \pm 1% resistor (0603)
R9–R13	0	Not installed, resistors—shorted by PCB trace (0402)

Windows and Windows Vista are registered trademarks of Microsoft Corp.



MAX9597 Evaluation Kit

Component List (continued)

DESIGNATION	QTY	DESCRIPTION
R14–R21, R28–R35, R54, R55	18	75Ω ±5% resistors (0603)
R24–R27, R37, R38, R39, R43, R44, R45, R50, R51	12	0Ω ±5% resistors (0603)
R40, R41, R46–R49, R52, R53	0	Not installed, resistors (0603)
U1	1	Single SCART interface (28 TQFN-EP*) Maxim MAX9597CTI+
U2	1	Microcontroller (68 QFN-EP*) Maxim MAXQ2000-RAX+
U3	1	LDO regulator (5 SC70) Maxim MAX8511EXK25+

*EP = Exposed pad.

DESIGNATION	QTY	DESCRIPTION
U4	1	Adjustable output LDO regulator (5 SC70) Maxim MAX8512EXK+
U5	1	UART-to-USB converter (32 TQFP) FTDI FT232BL
U6	1	93C46 type 3-wire EEPROM (8 SO) Atmel AT93C46A-10SU-2.7
Y1	1	16MHz crystal (HCM49) Hong Kong X'tals SSM1600000E18FAF
Y2	1	6MHz crystal (HCM49) Hong Kong X'tals SSL600000E18FAF
—	4	Shunts
—	1	USB high-speed A-to-B cables, 5ft (1.5m)
—	1	PCB: MAX9597 Evaluation Kit+

Component Suppliers

SUPPLIER	PHONE	WEBSITE
Central Semiconductor Corp.	631-435-1110	www.centralsemi.com
Hong Kong X'tals Ltd.	852-35112388	www.hongkongcrystal.com
KYCON, Inc.	408-494-0330	www.kycon.com
Murata Electronics North America, Inc.	770-436-1300	www.murata-northamerica.com
TDK Corp.	847-803-6100	www.component.tdk.com

Note: Indicate that you are using the MAX9597 when contacting these component suppliers.

MAX9597 EV Kit Files

FILE	DESCRIPTION
INSTALL.EXE	Installs the EV kit files on your computer
MAX9597.EXE	Application program
FTD2XX.INF	USB driver file
UNINST.INI	Uninstalls the EV kit software
USB_Driver_Help.PDF	USB driver installation help file

MAX9597 Evaluation Kit

Quick Start

Recommended Equipment

Before beginning, the following equipment is needed:

- MAX9597 EV kit (USB cable included)
- A user-supplied Windows 2000/XP/Vista PC with a spare USB port
- 12V/100mA DC power supply (V12)
- 3.3V/250mA DC power supply (VVID)
- 3.3V/100mA DC power supply (VAUD)
- DVD player with composite video, RGB video, left audio, and right audio outputs

Note: In the following sections, software-related items are identified by bolding. Text in **bold** refers to items directly from the EV kit software. Text in **bold and underlined** refers to items from the Windows operating system.

Procedure

The MAX9597 EV kit is fully assembled and tested. Follow the steps below to verify board operation.

Caution: Do not turn on the power supplies until all connections are made.

- 1) Visit www.maxim-ic.com/evkitsoftware to download the latest version of the EV kit software, 9597Rxx.ZIP. Save the EV kit software to a temporary folder and uncompress the ZIP file.
- 2) Install the EV kit software on your computer by running the INSTALL.EXE program inside the temporary folder. The program files are copied and icons are created in the Windows **Start | Programs** menu.
- 3) Verify that all jumpers (JU1–JU4) are in their default positions, as shown in Tables 1 and 2. **Do not turn on the power supplies until all connections are made.**
- 4) Connect the 12V/100mA DC power supply to the V12 and the GNDV12 pads on the MAX9597 EV kit board.
- 5) Connect the 3.3V/250mA DC power supply to the VVID and the GNDVID pads on the MAX9597 EV kit board.
- 6) Connect the 3.3V/100mA DC power supply to the VAUD and the GNDAUD pads on the MAX9597 EV kit board.
- 7) Connect the GNDVID and GNDAUD pads together at the board.
- 8) Connect the GNDV12 and GNDAUD pads together at the board.
- 9) Connect the GNDDIG and GNDAUD pads together at the board.
- 10) Connect the DVD composite video output to the ENC_Y/CVBS_IN input of the MAX9597 evaluation kit. Connect the DVD R, G, and B outputs to the ENC_R/C_IN, ENC_G_IN, and ENC_B_IN inputs, respectively. The video signals must be between 0 and 1V, approximately. If the video signals are not between 0 and 1V, refer to Application Note 4028: *How to Level Shift Video Signals for DC-Coupled Video Amplifiers/Filters*, available at www.maxim-ic.com.
- 11) Connect the DVD left and right audio outputs to the DL_INP and DR_INP inputs of the MAX9597 EV kit, respectively. The ENC_INL+ and ENC_INR+ expect the incoming audio signals to be 0.5V_{RMS} full scale and to be centered around ground. Most of the audio output signals from DVD players are 2V_{RMS}. If the DVD player has an audio volume control, reduce the audio volume such that the full-scale audio signal is $\leq 0.5V_{RMS}$. If the DVD player does not have an audio volume control, replace R37 and R43 with 30k Ω resistors. The audio signals are then attenuated by a factor of 4 before being presented to ENC_INL+ and ENC_INR+. Most incoming audio signals are centered around ground. If not, add a 10 μ F capacitor in series with the audio source.
- 12) Connect a TV to the TV (P2) SCART connector.
- 13) Connect the USB cable from the PC to the EV kit board. A **New Hardware Found** window pops up when installing the USB driver for the first time. If you do not see a window that is similar to the one described above after 30s, remove the USB cable from the board and reconnect it. Administrator privileges are required to install the USB device driver on Windows.
- 14) Follow the directions of the **Add New Hardware Wizard** to install the USB device driver. Choose the **Search for the best driver for your device** option. Specify the location of the device driver to be **C:\Program Files\MAX9597** (default installation directory) using the **Browse** button. During device driver installation, Windows might show a warning message indicating that the device driver Maxim uses does not contain a digital signature. This is not an error condition and it is safe to proceed with installation. Refer to the USB_Driver_Help.PDF document included with the software for additional information.

MAX9597 Evaluation Kit

- 15) Turn on the power supplies.
- 16) Start the EV kit software by opening its icon in the **Start | Programs** menu. The EV kit software main window appears, as shown in Figure 1. Observe as the program automatically detects the address of the MAX9597 and starts the main program.

Detailed Description of Software

User Interface

The user interface (Figure 1) is easy to operate. Use the mouse, or press the tab key to navigate with the arrow keys. Each of the buttons correspond to bits in the command and configuration bytes. By pressing them, the correct I²C-compatible write operation is generated to update the internal registers of the MAX9597. The **Interface** group box indicates the current I²C-compatible **Device Address**, **Register Address Sent**, and the **Data Sent/Received**, for the last read/write operation. This data is used to confirm proper device operation.

The MAX9597 EV kit software splits and groups the functions of the MAX9597 into two separate categories. **TV** and **Configuration** control functions are accessed by selecting the appropriate tab at the top left of the MAX9597 EV kit software main window. The **TV** tab sheet of the MAX9597 EV kit software is again split into two sections (**Video Control** and **Audio Control**).

Click the **POR Reset** button to reset the MAX9597 registers and EV kit software to their power-on-reset configuration.

TV Controls (Video/Audio)

The **Video Control** group box of the MAX9597 EV kit software (Figure 1) allows the user to select functions, such as **Slow Switching** and **Fast Switching**, by manipulating the drop-down lists (refer to the MAX9597 IC data sheet for a description of each of these functions).

The **Audio Control** group box of the MAX9597 EV kit software allows the user to adjust various audio characteristics of the TV output, such as **Mute** and **Zero Crossing Detector**.

Table 1. Shunt Setting for SMBus/I²C Address (JU1)

SHUNT POSITION	DEV_ADDR	B7	B6	B5	B4	B3	B2	B1	B0	WRITE ADDRESS (HEX)	READ ADDRESS (HEX)
1-2*	VVID	1	0	0	1	0	1	1	R/W	0x96	0x97
1-3	SCL	1	0	0	1	1	0	0	R/W	0x98	0x99
1-4	GND	1	0	0	1	0	1	0	R/W	0x94	0x95
1-5	SDA	1	0	0	1	1	0	1	R/W	0x9A	0x9B

*Default position.

Table 2. MAX9597 EV Kit Jumper Description (JU2, JU3, JU4)

JUMPER	SHUNT POSITION	DESCRIPTION
JU2	1-2*	Connect to on-board SCL
	2-3	Connect user-supplied SCL
JU3	1-2*	Connect to on-board SDA
	2-3	Connect user-supplied SDA
JU4	1-2*	Connect to on-board +3.3V supply
	2-3	Connect user-supplied +3.3V

*Default position.

MAX9597 Evaluation Kit

Evaluates: MAX9597

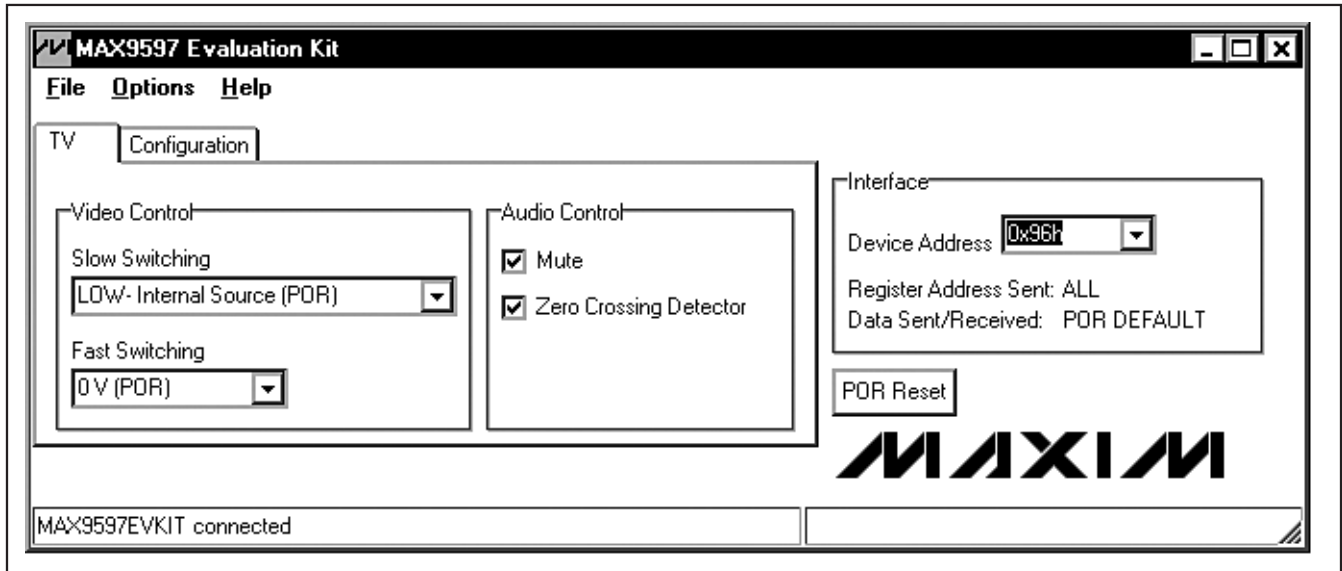

Figure 1. MAX9597 EV Kit Software Main Window (TV Tab)

Configuration Control

Selecting the **Configuration** tab sheet (Figure 2) of the MAX9597 EV kit software allows the user to adjust configuration features of the MAX9597. Checking the desired checkboxes in the **Output Enable** group box enables selected outputs of the MAX9597. The **Operating Modes** group box allows the user to select

Full Power (POR) or **Shutdown** mode. A bias voltage can also be applied at the R/C input of the encoder (**Chrominance Bias at ENC_R/C_IN**). The EV kit software checks to see if the slave is present every second. Checking the **Disable I2C Activity** checkbox stops activity between the microcontroller and the MAX9597 when software is idle.

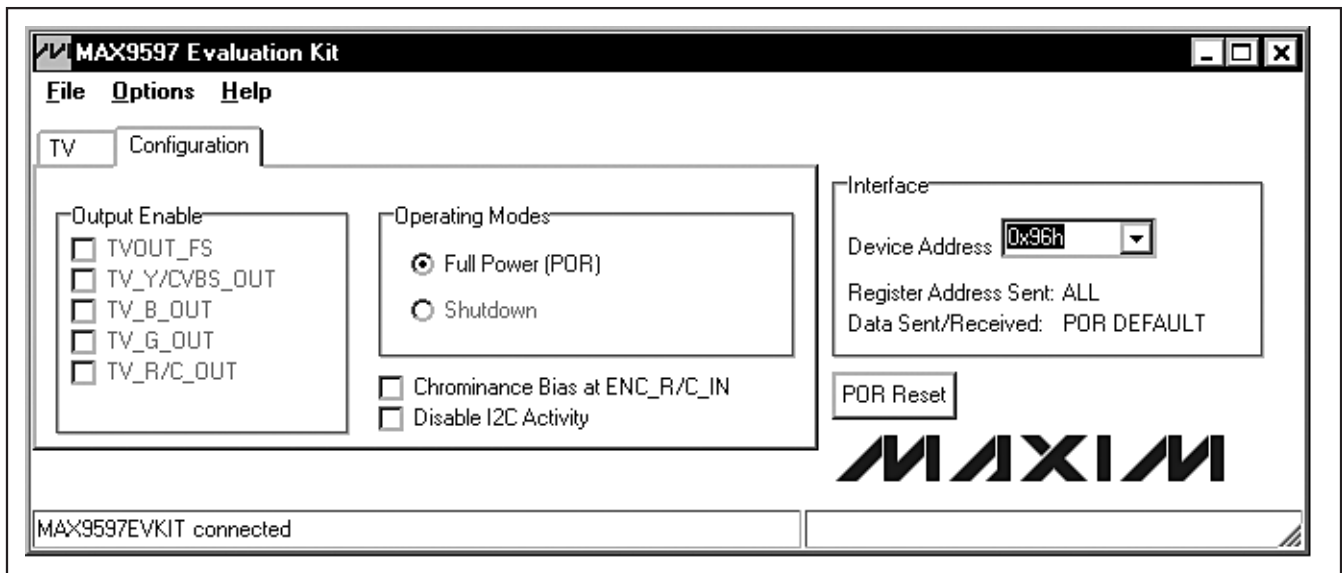

Figure 2. MAX9597 EV Kit Software Main Window (Configuration Tab)

MAX9597 Evaluation Kit

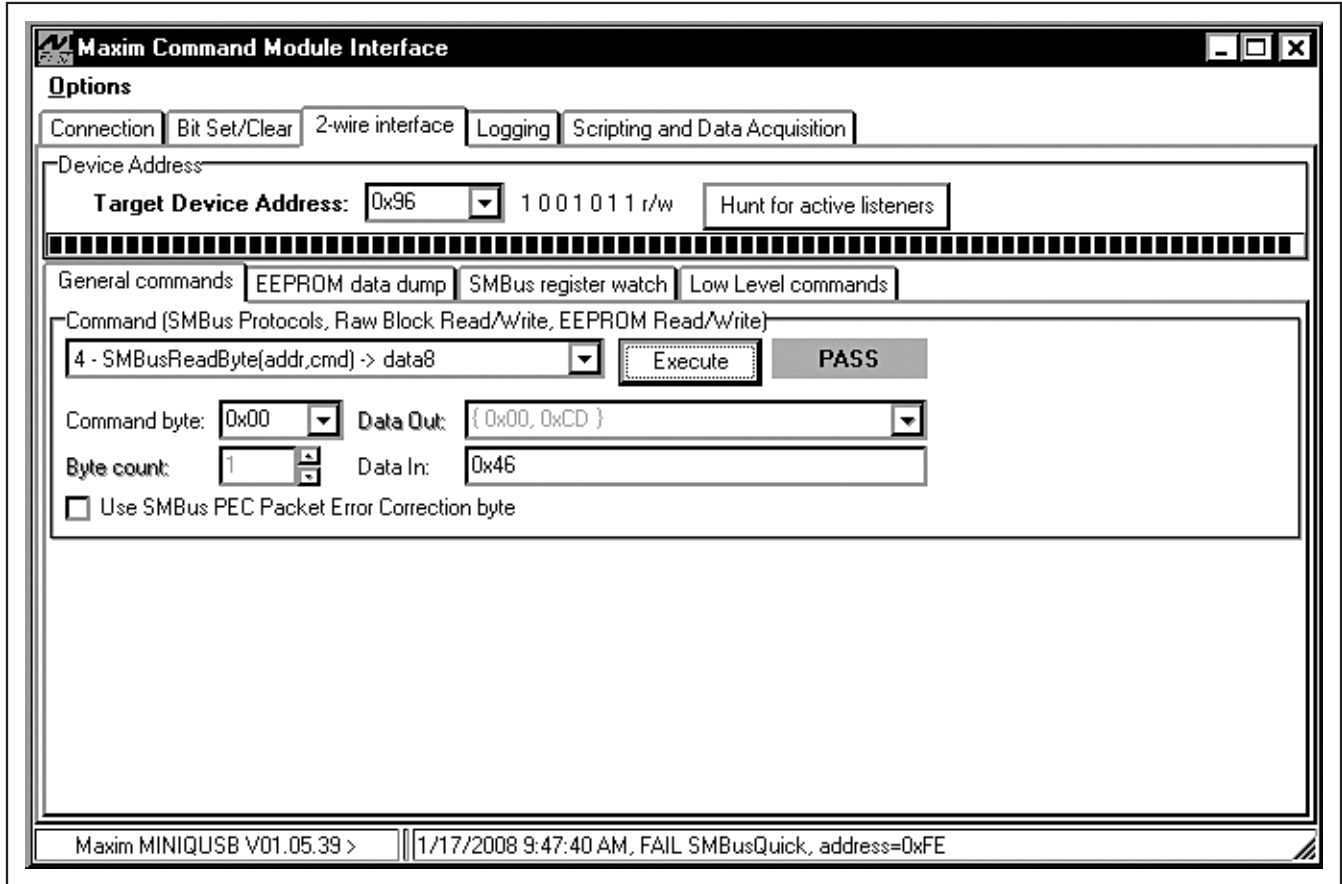

Figure 3. Example of a Simple SMBusReadByte Operation Using the Advanced User Interface

Advanced User Interface

There are two methods for communicating with the MAX9597: through the normal user-interface main window or through the I²C commands available by selecting **Options | Interface (Advanced Users)** from the menu bar. A display pops up that allows the SMBus™/I²C-compatible protocols, such as **Read Byte** and **Write Byte**, to be executed. The only SMBus/I²C compatible protocols used by the MAX9597 are:

- **1 - SMBusWriteByte(addr,cmd,data8)**
- **4 - SMBusReadByte(addr,cmd) → data8**

The combo and edit boxes accept numeric data in hexadecimal and should be prefixed by 0x. See Figure 3 for an example of this tool.

In this example, the software is reading from device address 1001011 (r/w) binary, and register address 0x00.

SMBus is a trademark of Intel Corp.

Detailed Description of Hardware

The MAX9597 EV kit is an assembled and tested PCB that demonstrates the features of the MAX9597 single SCART interface. It routes audio, video, and control signals between a set-top box decoder chip and the TV SCART connector. All video connections are made through 75Ω controlled-impedance traces. Connect a TV to the corresponding TV SCART connector. The set-top box decoder video connections are made through the 75Ω BNCs with the ENC prefix. Audio signals from the stereo audio DAC are connected to the white (P3, P4, P5) and red (P6, P7, P8) RCA phono jacks.

Address Selection

Jumper JU1 sets the MAX9597 slave address. The default address is 1001 011(r/w) (DEV_ADDR = VVID). See Table 1 for a complete list of addresses.

MAX9597 Evaluation Kit

AC-Coupling of Incoming Video Signals

Most of the video DACs on set-top box chips generate video signals between 0 and 1V. Therefore, the most convenient connection between the set-top box chip and the MAX9597 video inputs is a DC connection. If the video DAC does not generate a video signal between 0 and 1V, or if the incoming video signals are from an external source, then the video signal should be AC-coupled through a 0.1µF capacitor. The internal transparent clamp or input bias circuit of the MAX9597 restores the DC level of the video signal to the proper voltage, such that the MAX9597 can process the signal properly.

If a chroma signal is AC-coupled into ENC_R/C_IN, the input bias circuit should be activated by checking the **Chrominance Bias at ENC_R/C_IN** checkbox. The chroma signal does not have a sync pulse, so the transparent sync-tip clamp circuit cannot set a chroma signal to the correct DC level. If a red, composite, or luma video signal is AC-coupled into ENC_R/C_IN, leave the checkbox unchecked.

S-Video Signal Evaluation

Connect the luma signal of the DVD S-video output to the ENC_Y/CVBS_IN input of the MAX9597 EV kit, and

connect the chroma signal of the DVD S-video output to the ENC_R/C_IN input. If the DVD player has an S-video connector (4-pin DIN), then an S-video to BNC “Y” connector cable can be used to break out the luma and chroma signals separately. The video signals must be between 0 and 1V, approximately. If the video signals are not between 0 and 1V, see the previous section.

Audio Lowpass Filter Circuits

The audio circuit is essentially a left audio path and a right audio path, each with an independent op amp followed by a gain-of-4 amplifier. The encoder (stereo audio DAC) is the input source and the output goes to the TV SCART connector (Figure 4).

The full-scale output of the independent op amp is 0.5V_{RMS}. The closed-loop gain of the op amp circuit should be designed such that the resulting full-scale output is 0.5V_{RMS}. The fixed, gain-of-4 amplifiers that follow the independent op amps amplify the 0.5V_{RMS} to 2V_{RMS}, which complies with the SCART standard.

The lowpass filter configurations shown in Figures 5 and 6 are recommended when connecting a stereo audio DAC to the audio preamplifier (input amplifier) of the MAX9597. The filter configuration helps eliminate

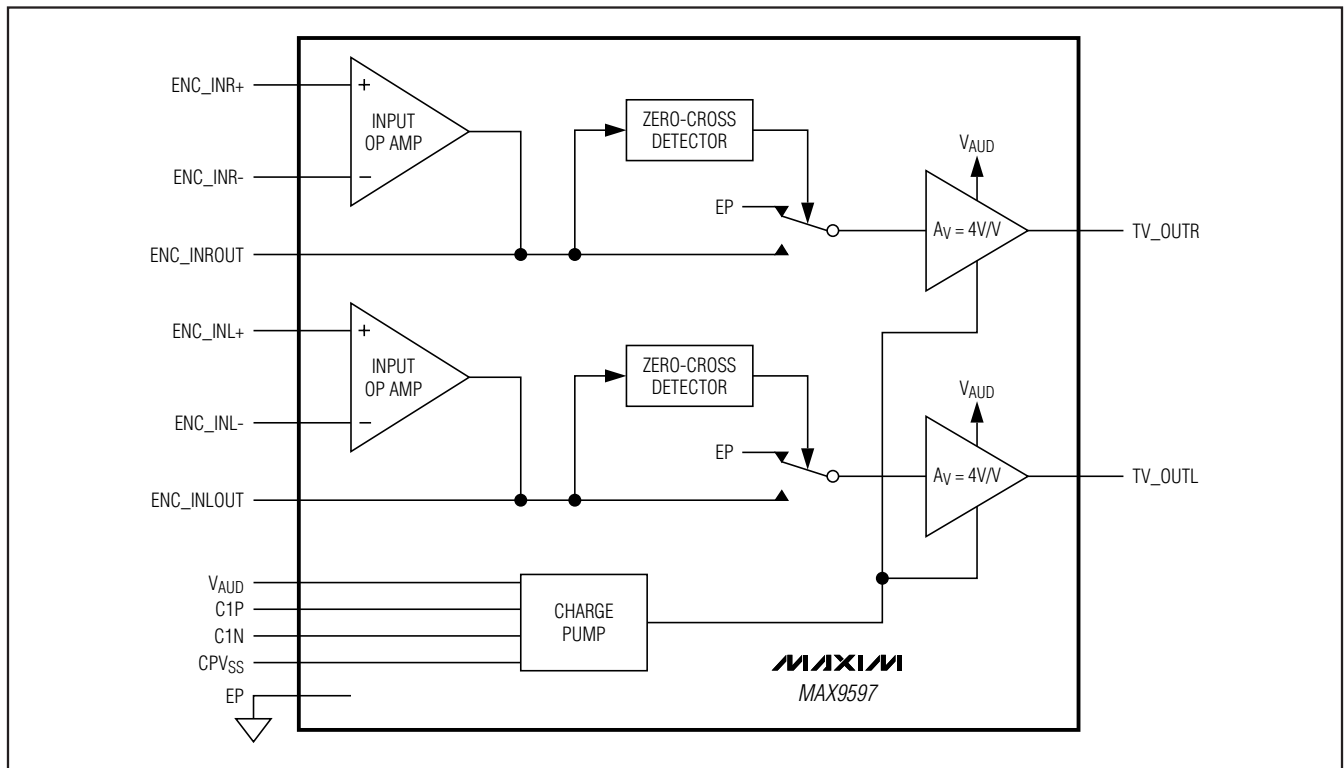

Figure 4. MAX9597 Audio Section Functional Diagram

MAX9597 Evaluation Kit

The audio input circuit of the MAX9597 has been designed such that the existing resistors and capacitors can be replaced to create the lowpass filter circuits

for the PCM1742 and the CS4334. See Table 3 for component values.

Table 3. Component Values to Create Audio Lowpass Filter Circuits (PCM1742 and CS4334)

DESIGNATION	VALUES		
	DEFAULT	PCM1742	CS4334
CAPACITORS			
C35, C47	Open	1.2nF	2.7nF
C43, C51	10 μ F	10 μ F	10 μ F
C44, C48	Open	Open	Open
C45, C49	Open	390pF	560pF
C46, C50	Open	Open	3.3nF
RESISTORS			
R36, R42	10k Ω	Open	Open
R37, R43	0 Ω	0 Ω	0 Ω
R38, R44	0 Ω	0 Ω	1.21k Ω
R39, R45	0 Ω	3.01k Ω	2.4k Ω
R40, R46	Open	6.04k Ω	4.64k Ω
R41, R47	Open	604 Ω	1.21k Ω
R48, R49	Open	Open	270k Ω
R50, R51	0 Ω	Open	Open
R52, R53	Open	3.01k Ω	3.57k Ω
R54, R55	75 Ω	Open	Open

Evaluates: MAX9597

MAX9597 Evaluation Kit

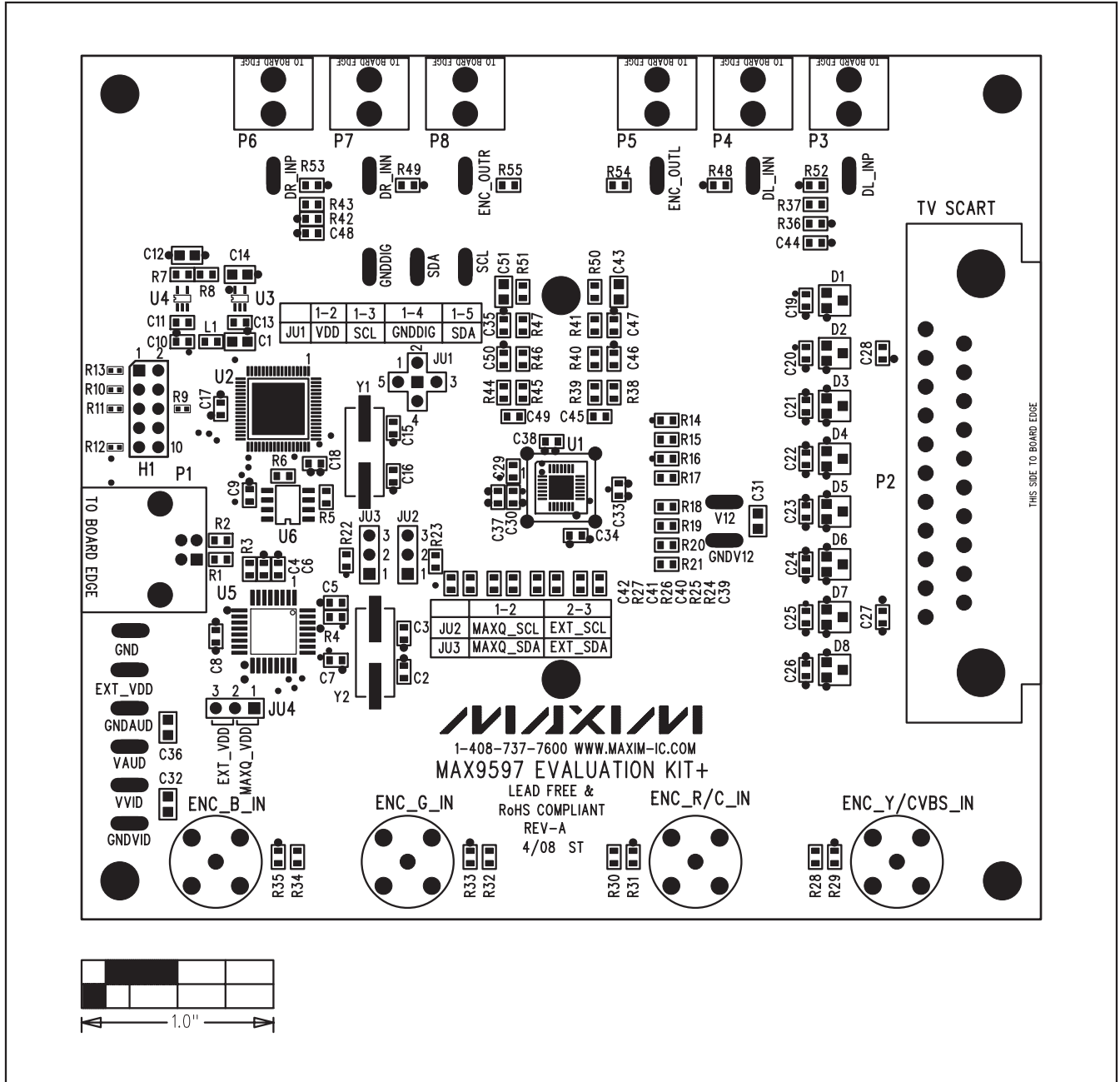

Figure 8. MAX9597 EV Kit Component Placement Guide—Component Side

MAX9597 Evaluation Kit

Evaluates: MAX9597

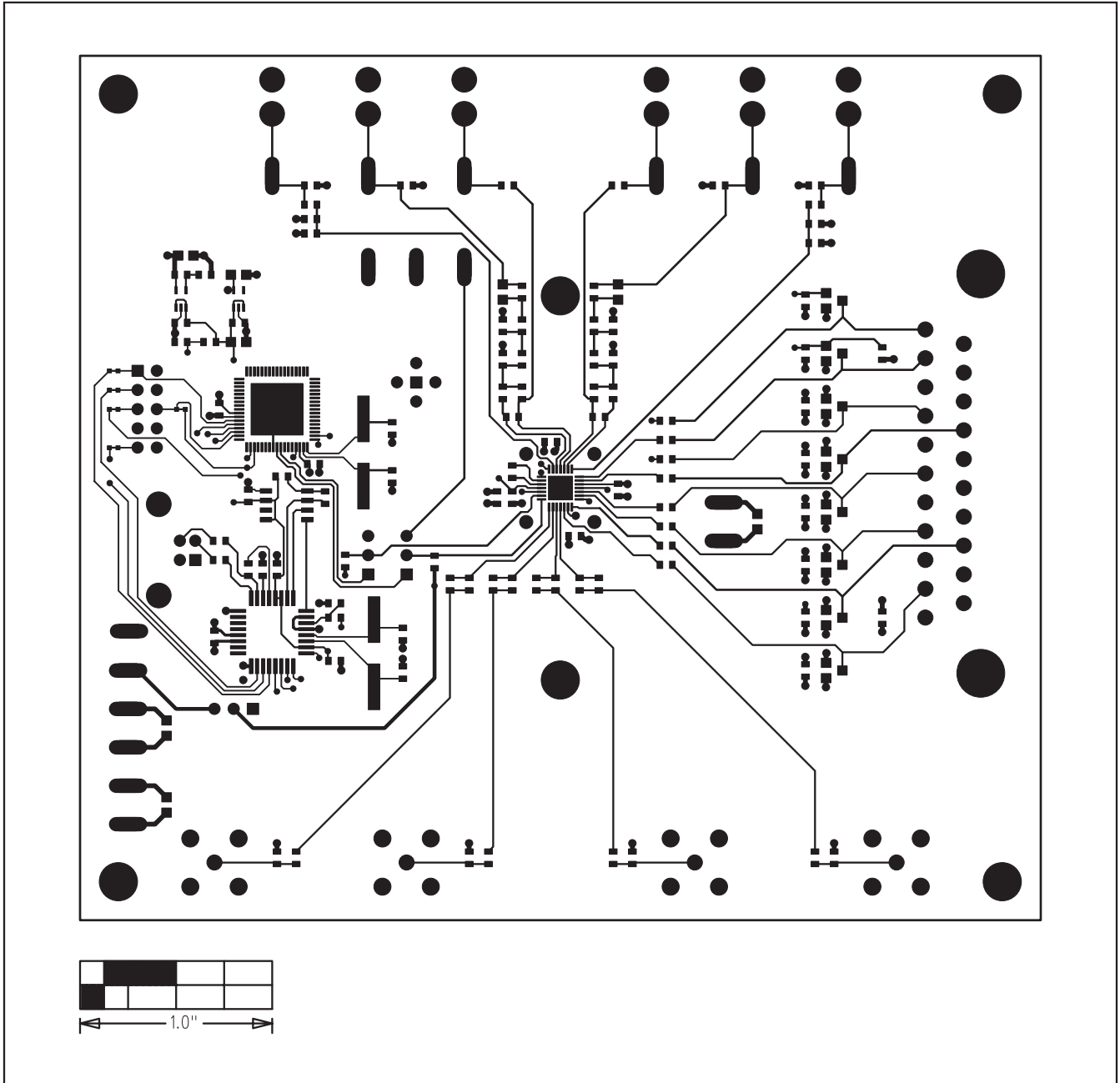

Figure 9. MAX9597 EV Kit Component PCB Layout—Component Side

MAX9597 Evaluation Kit

Evaluates: MAX9597

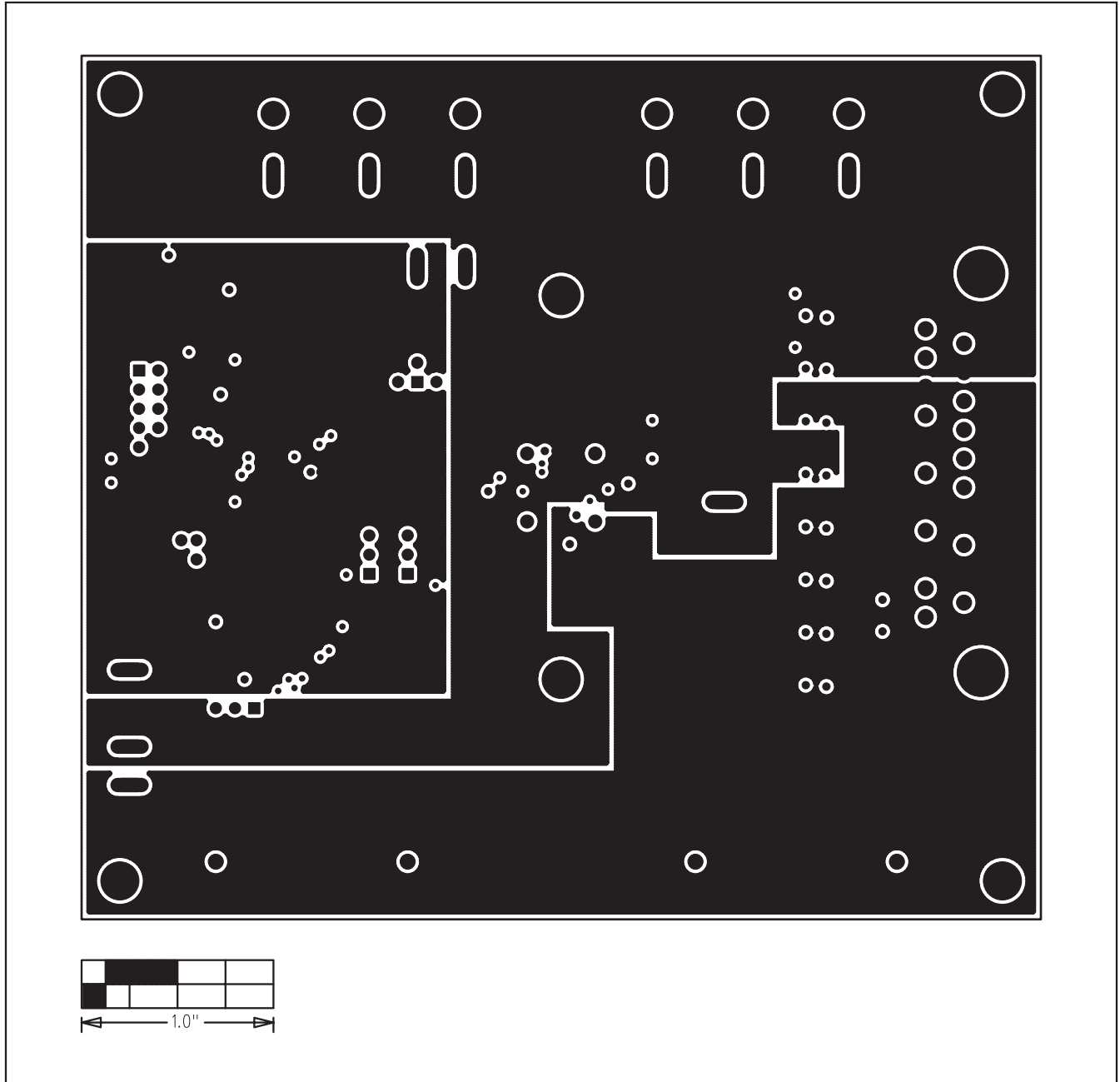

Figure 10. MAX9597 EV Kit PCB Layout—Inner Layer 2

MAX9597 Evaluation Kit

Evaluates: MAX9597

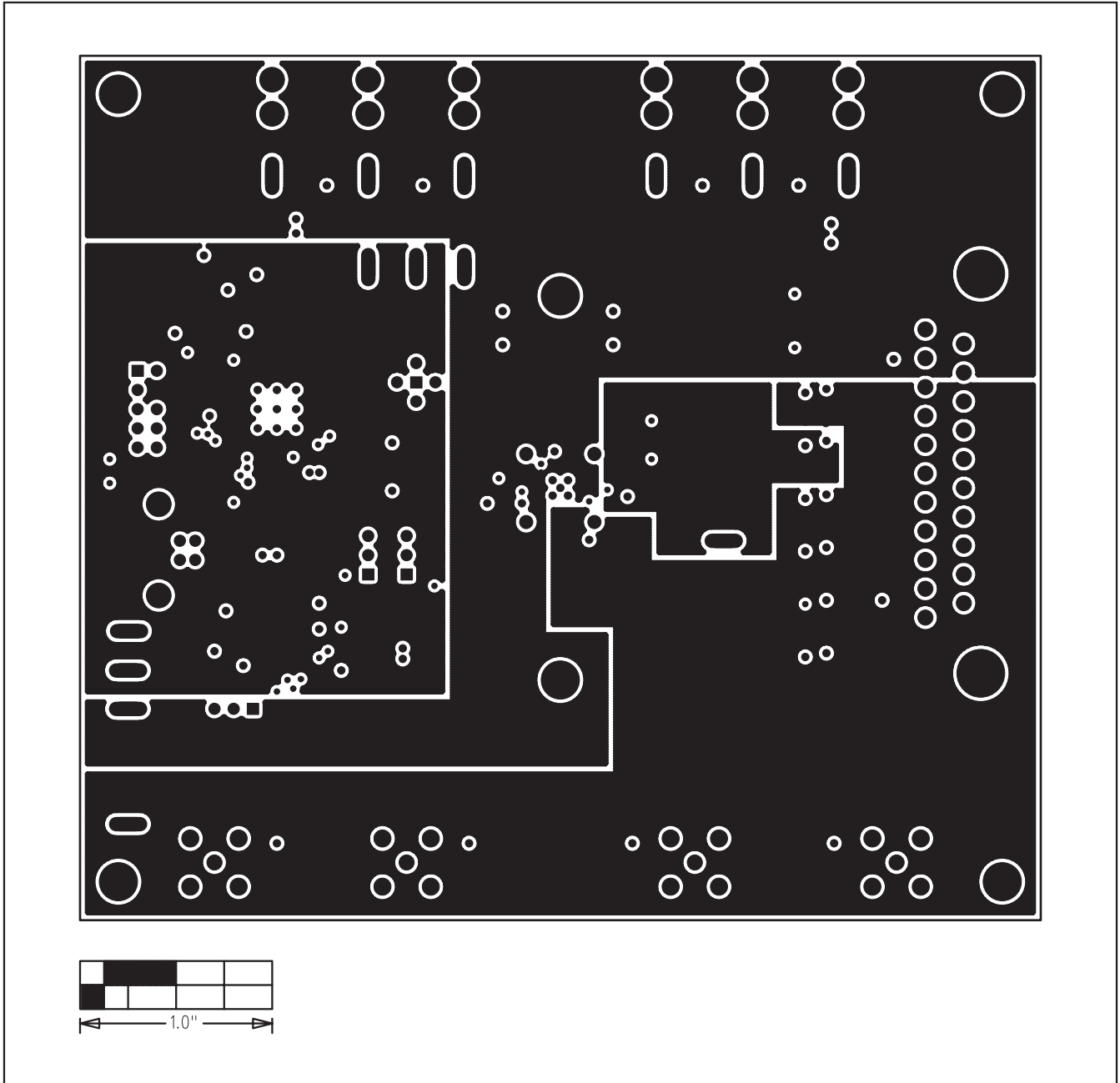

Figure 11. MAX9597 EV Kit PCB Layout—Inner Layer 3

MAX9597 Evaluation Kit

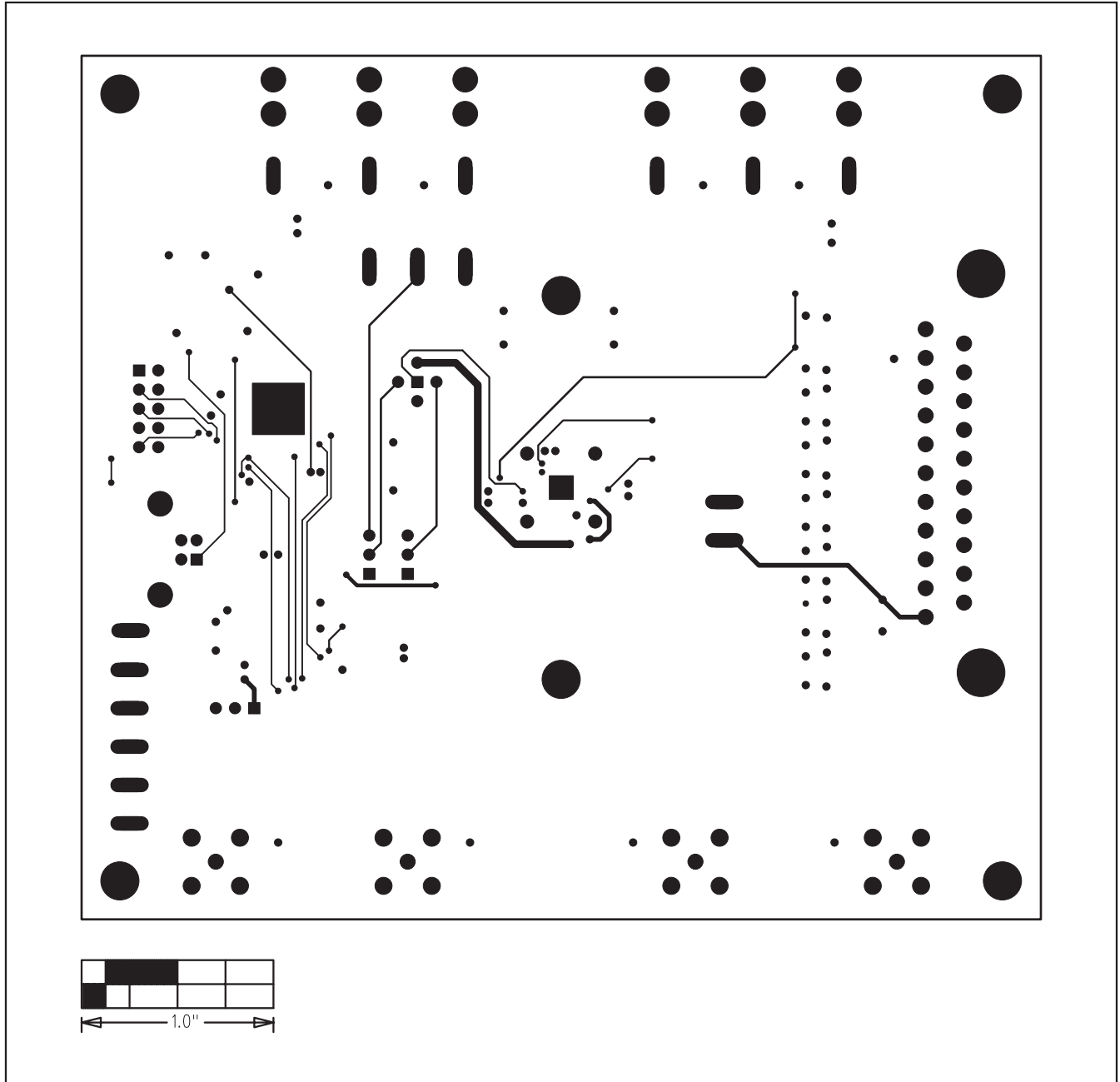

Figure 12. MAX9597 EV Kit PCB Layout—Solder Side

Maxim cannot assume responsibility for use of any circuitry other than circuitry entirely embodied in a Maxim product. No circuit patent licenses are implied. Maxim reserves the right to change the circuitry and specifications without notice at any time.

16 **Maxim Integrated Products, 120 San Gabriel Drive, Sunnyvale, CA 94086 408-737-7600**