



# MAX8677A Evaluation Kit

## General Description

The MAX8677A evaluation kit (EV kit) demonstrates the MAX8677A dual-input charger and Smart Power Selector™ IC. The EV kit charges a single-cell Li-ion (Li+) battery from a DC input (AC adapter) or a USB 100mA/500mA source and provides system power from the DC input, USB input, or battery. The DC input has a resistor-adjustable current limit, while USB current input limit is logic programmed to 100mA/500mA. USB suspend mode is also supported. The charge current is adjustable from 300mA to 1.5A. The system load has priority over the charger so that charge current is reduced as necessary to prevent input overload. Charge current is also thermally regulated.

Smart Power Selector is a trademark of Maxim Integrated Products, Inc.

## Features

- ◆ DC Input Current Limit of 2A (EV Kit Standard Configuration)
- ◆ DC Input Current-Limit-Adjustment Range of 0.5A to 2A
- ◆ USB Current Limit of 100mA or 500mA
- ◆ Charge-Current Limit of 1A (EV Kit Standard Configuration)
- ◆ Charge-Current-Adjustment Range of 0.3A to 1.5A
- ◆ Input Current Thermal-Limit Threshold of +100°C
- ◆ 24-Pin, 4mm x 4mm Thin QFN Package

## Ordering Information

PART	TEMP RANGE	IC PACKAGE
MAX8677AEVKIT+	0°C to +70°C	24 Thin QFN (4mm x 4mm)

+Denotes a lead-free and RoHS-compliant EV kit.

## Component List

DESIGNATION	QTY	DESCRIPTION
C1, C2, C3	3	4.7μF ±10%, 10V X5R ceramic capacitors (0805) TDK C2012X5R1A475K
C4	1	10μF ±10%, 16V X5R ceramic capacitor (1206) Taiyo Yuden EMK316BJ106KL
C5	1	0.068μF ±10%, 10V X7R ceramic capacitor (0402) TDK C1005X5R1A683K
C6	1	0.1μF ±10%, 10V X7R ceramic capacitor (0402) TDK C1005X5R1A683K
C7, C8	0	Not installed, capacitors
D1–D5	5	Small red LEDs Panasonic LNJ208R8ARA
J1	1	USB type-AB mini jack, right-angle Molex 56579-0576
JU1–JU5	5	3-pin headers 36-pin header, 0.1in centers (comes in 36-pin strips, cut to fit) Sullins PEC36SAAN Digi-Key S1012E-36-ND

DESIGNATION	QTY	DESCRIPTION
JU6, JU7	2	2-pin headers 36-pin header, 0.1in centers (comes in 36-pin strips, cut to fit) Sullins PEC36SAAN Digi-Key S1012E-36-ND
R1–R5,	5	4.7kΩ ±5% resistors (0402), lead free
R6	1	1.5kΩ ±1% resistor (0402), lead free
R7	1	3.01kΩ ±1% resistor (0402), lead free
R8, R9	2	10kΩ ±1% resistors (0402), lead free
R10	1	Not installed, resistor (0402)
NTC	0	Not installed, NTC thermistor (0603)
<b>U1</b>	<b>1</b>	<b>MAX8677AETG+</b>
—	5	Shunts Sullins Electronics Corp. STC02SYAN Mouser 151-8000 or Digi-Key # S9000-ND or equivalent
—	1	PCB: MAX8677A Evaluation Kit+

# MAX8677A Evaluation Kit

## Component Suppliers

SUPPLIER	PHONE	WEBSITE
Kamaya Inc.	260-489-1533	www.kamaya.com
Mouser/Molex	800-346-6873	www.mouser.com/molex
Panasonic Corp.	714-373-7366	www.panasonic.com
Taiyo Yuden	408-573-4150	www.t-yuden.com
TDK Corp.	847-803-6100	www.component.tdk.com
Vishay	402-563-6866	www.vishay.com

**Note:** Indicate that you are using the MAX8677A when contacting these component suppliers.

## Quick Start

### Recommended Equipment

- Adjustable DC power supply capable of 7V at 3A
- Li+ battery or a 2A, 4.5V power supply capable of sinking current

- Digital multimeter (DMM)
- Up to 3A adjustable load
- Three 10A ammeters

### Procedure

The MAX8677A EV kit is fully assembled and tested. Follow the steps below to verify board operation. Use twisted wires of appropriate gauge that are as short as possible to connect the battery and power sources:

- 1) Preset the DC power supply to 5V. Turn off the power supply. **Do not turn on the power supply until all connections are made.**
- 2) Preset the adjustable load to 0A.
- 3) Connect the EV kit to the power supply, battery, adjustable load, and meter, as shown in Figure 1.
- 4) Ensure that the EV kit has jumper settings configured as shown in Table 1, and also shown in Figure 1.
- 5) Turn on the power supply.

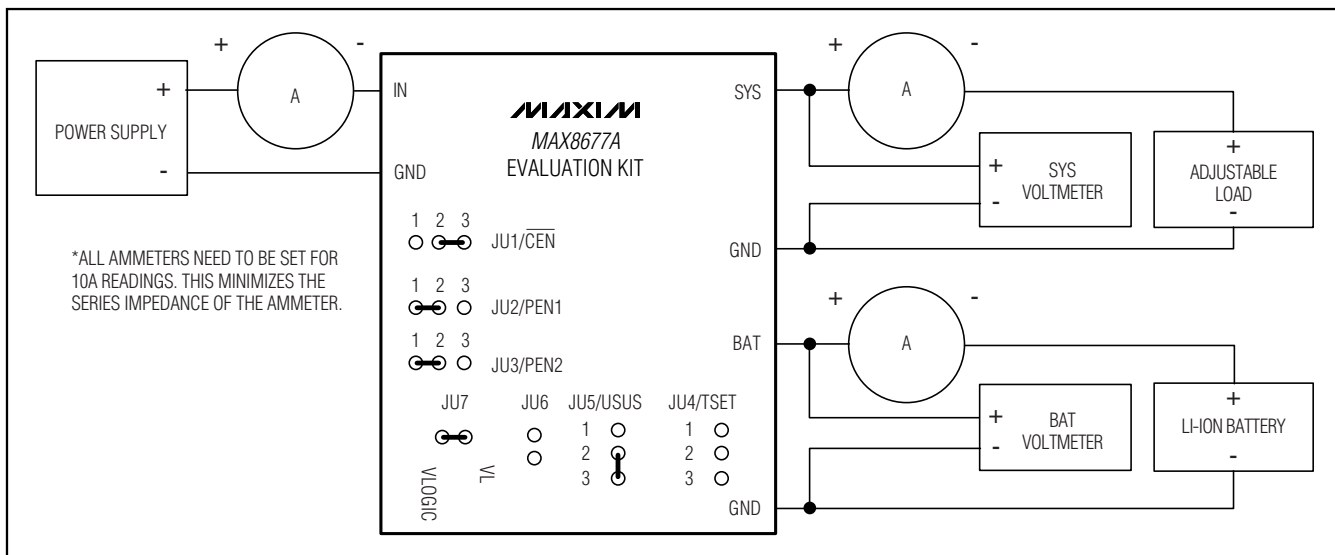

Figure 1. Test Procedure Setup

## Table 1. Jumper Settings

JUMPER	LABEL	DEFAULT POSITION	NOTES
JU1	CEN	2-3	Enables charger
JU2	PEN1	1-2	Configures DC input as adapter source
JU3	PEN2	1-2	500mA setting for USB power at DC input
JU4	TSET	Open	5% (1-2), 10% (open), 15% (2-3)
JU5	USUS	2-3	Not in USB suspend mode
JU6	—	Open	Ties THM to GND to bypass thermistor function
JU7	—	Short	Connects V <sub>LOGIC</sub> to VL

# MAX8677A Evaluation Kit

- 6) Verify that the voltage at SYS is approximately 5V.
- 7) If  $V_{BAT}$  is less than 4.05V, verify that the current from BATT+ into the battery is approximately 1A.
- 8) Increase the load current on SYS to 1A.
- 9) Verify that the charge current into the battery remains near 1A.
- 10) Increase the load current on SYS to 1.5A.
- 11) Verify that the charge current into the battery is near 0.5A.
- 12) Increase the load current on SYS to 2.5A.
- 13) Verify that current out of the battery is near 0.5A.

## Detailed Description

### Adjusting the EV Kit for In-Circuit Evaluation

Follow the steps below to ensure that the EV kit is configured for operation in a specific application circuit:

- 1) Verify that the EV kit DC input current-limit setting is less than the AC adapter source current limit.
- 2) If necessary, replace R6 in the EV kit such that the DC input current is less than or equal to the AC adapter output-current capability.
- 3) Verify that the USB source can supply 100mA or 500mA.
- 4) Verify the maximum charge-current rating or desired charge-current rating of the battery.
- 5) Ensure that the charge-current setting of the EV kit does not exceed the battery rating, or replace resistor R7 as required. See the *Adjusting Input Current Limit and Charge-Current Limit* section for more details.

### Adjusting Input Current Limit and Charge-Current Limit

The input and charge current limits are set, as shown in Table 2. It is often preferable to change the input current limit as the input power source is changed. The MAX8677A facilitates this by allowing different input current limits for DC and USB inputs.

When the input current limit is reached, the first action taken by the MAX8677A is to reduce battery-charge current. This allows the SYS regulator to stay in drop-out, or at 5.3V, during heavy loads, thus reducing power dissipation. If, after the charge current is reduced to 0mA, the load at SYS still exceeds the input current limit, the SYS voltage starts falling. When the SYS voltage drops to BAT, the SYS-to-BAT switch turns on, using battery power to support the system load during the load peak.

The MAX8677A features flexible input connections (at the DC and USB input pins) and current-limit settings (set by PEN1, PEN2, PSET, and ISET) to accommodate nearly any input power configuration. However, it is expected that most systems use one of two external power schemes: separate connections for USB and an AC adapter, or a single connector that accepts either USB or the AC adapter output. Input and charge-current limits are controlled by PEN1, PEN2, RPSET, and RISET, as shown in Table 2.

### Charge Enable ( $\overline{CEN}$ )

When  $\overline{CEN}$  is low, the charger is on. When  $\overline{CEN}$  is high, the charger turns off.  $\overline{CEN}$  does not affect the SYS output. In many systems there is no need for the system controller (typically a microprocessor) to disable the charger, because the MAX8677A Smart Power Selector circuitry independently manages charging and adapter/battery power hand-off. In these situations,  $\overline{CEN}$  may be connected to ground.

**Table 2. Input Limiter Control Logic**

POWER SOURCE	$\overline{DOK}$	$\overline{UOK}$	PEN1	PEN2	USUS	DC INPUT CURRENT LIMIT	USB INPUT CURRENT LIMIT	MAXIMUM CHARGE CURRENT*
AC adapter at DC input	L	x	H	x	x	3000/R6	USB input off. DC input has priority.	3000/R7
USB power at DC input	L	x	L	L	L	100mA		100mA
	L	x	L	X	H	500mA		500mA
USB power at USB input, DC unconnected	L	x	L	X	H	USB suspend		0
	H	L	x	L	L	No DC input	100mA	3000/R7
	H	L	x	H	L		500mA	
	H	L	x	x	H		USB suspend	0
DC and USB unconnected	H	H	x	x	x		No USB input	0

\*Charge current cannot exceed the input current limit. Charge may be less than the maximum charge current if the total SYS load exceeds the input current limit.

x = Don't care.

# MAX8677A Evaluation Kit

## Charge Termination

When the charge current falls to the termination threshold AND the charger is in voltage mode, charging is complete. Charging continues for a brief 15s top-off period and then enters the DONE state where charging stops. The termination current threshold ( $I_{TERM}$ ) is set by TSET to a percentage of the fast-charge current:

Connect TSET to GND for  $I_{TERM} = I_{CHGMAX} \times 5\%$

Leave TSET open for  $I_{TERM} = I_{CHGMAX} \times 10\%$

Connect TSET to VL for  $I_{TERM} = I_{CHGMAX} \times 15\%$

When the charger enters DONE 15s later, the  $\overline{DONE}$  output goes low. Note that if charge current falls to  $I_{TERM}$  as a result of the input or thermal limiter, the charger does not enter DONE. For the charger to enter DONE, charge current must be less than  $I_{TERM}$ , the charger must be in voltage mode, and the input or thermal limiter must not be reducing charge current.

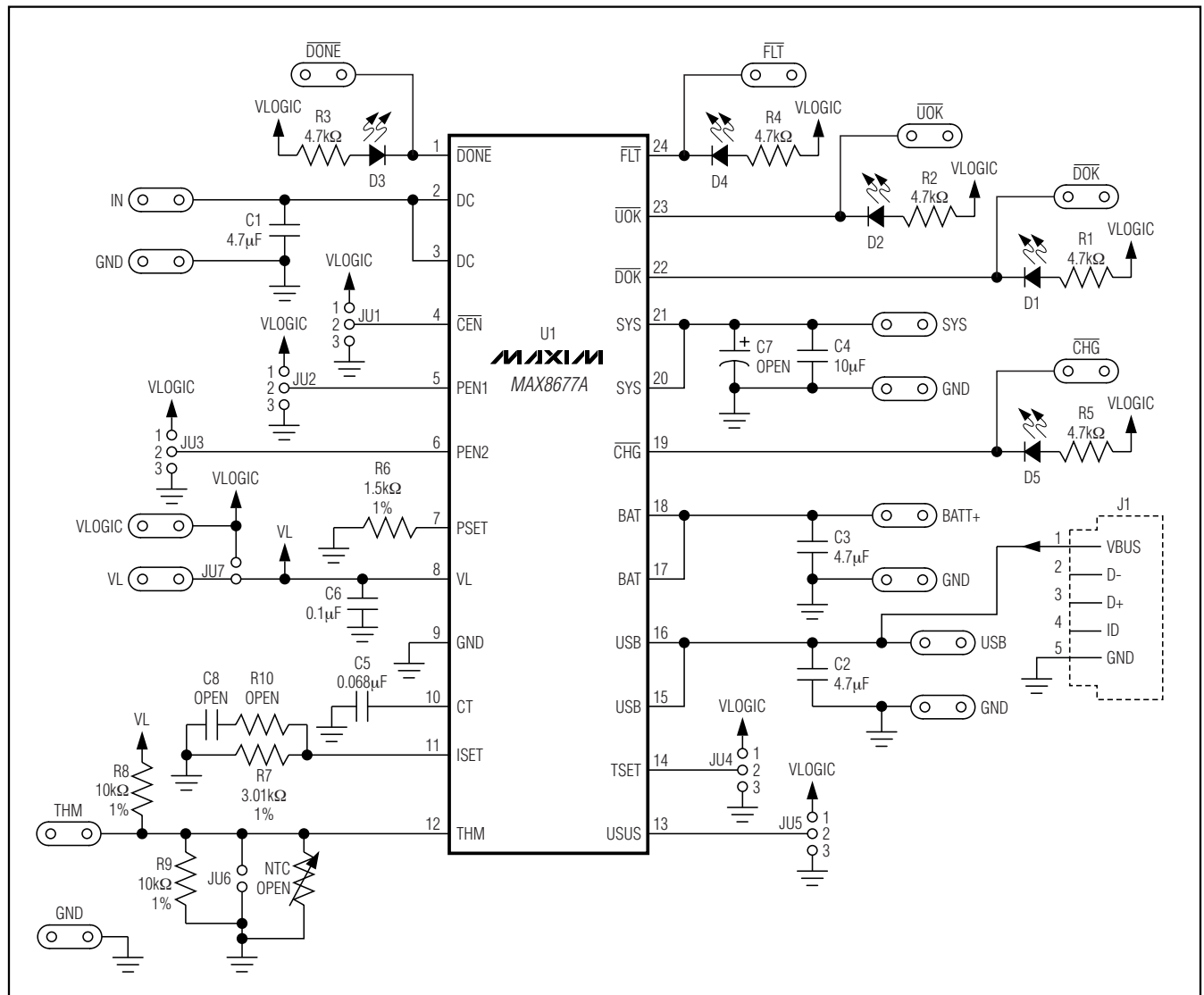

Figure 2. MAX8677A EV Kit Schematic

# MAX8677A Evaluation Kit

Evaluates: MAX8677A

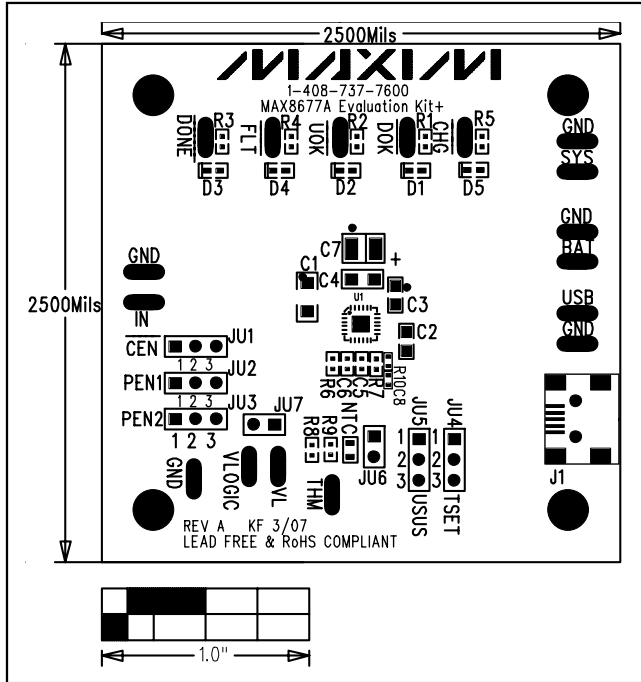

Figure 3. MAX8677A EV Kit Component Placement Guide—Component Side

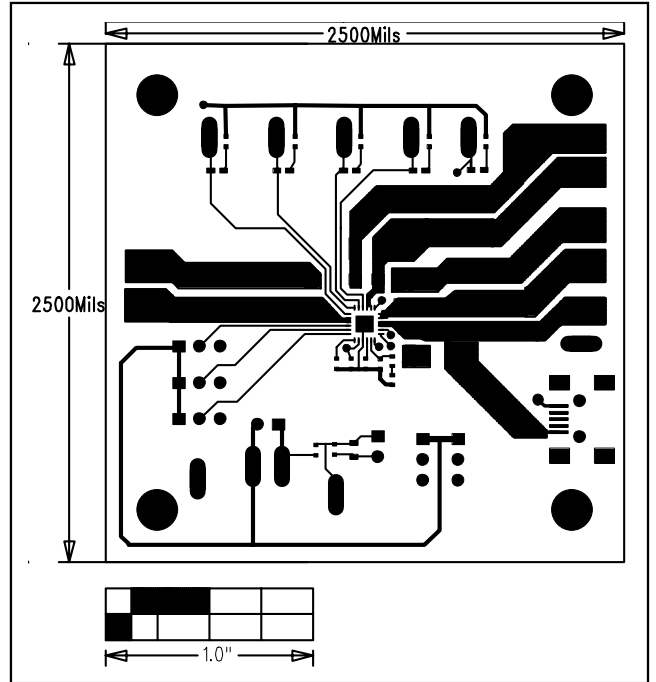

Figure 4. MAX8677A EV Kit PCB Layout—Component Side

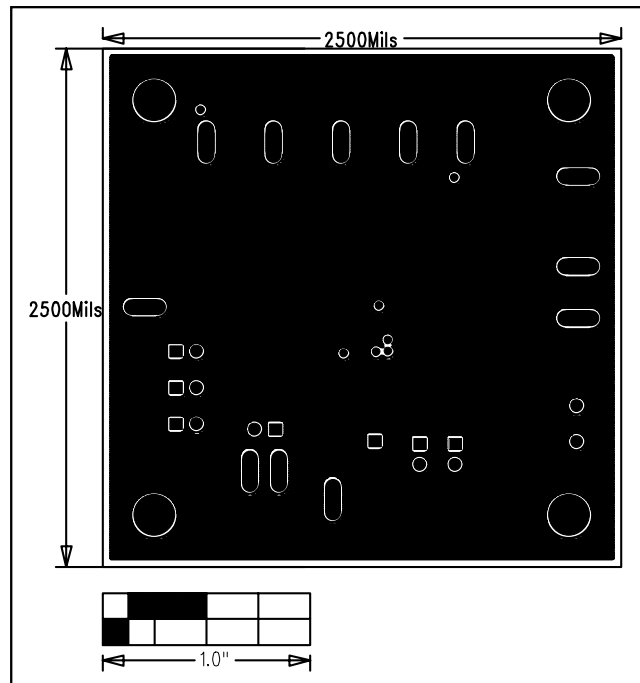

Figure 5. MAX8677A EV Kit PCB Layout—Layer 2

# MAX8677A Evaluation Kit

Evaluates: MAX8677A

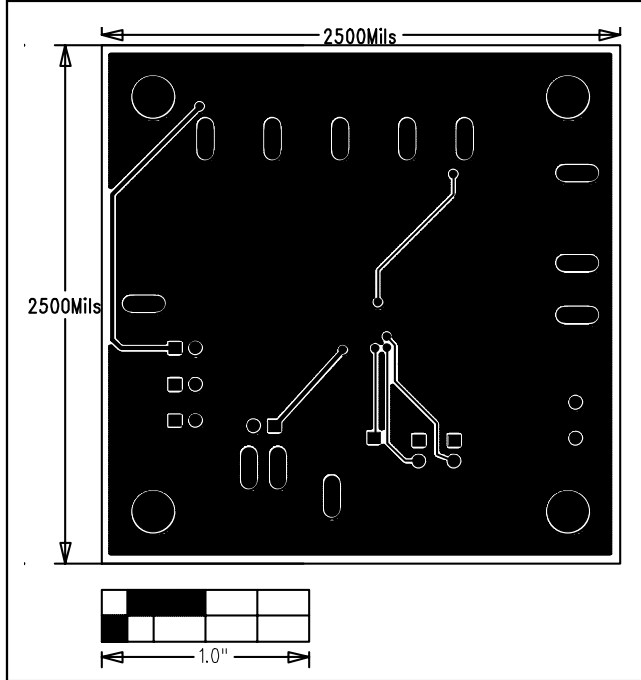

Figure 6. MAX8677A EV Kit PCB Layout—Layer 3

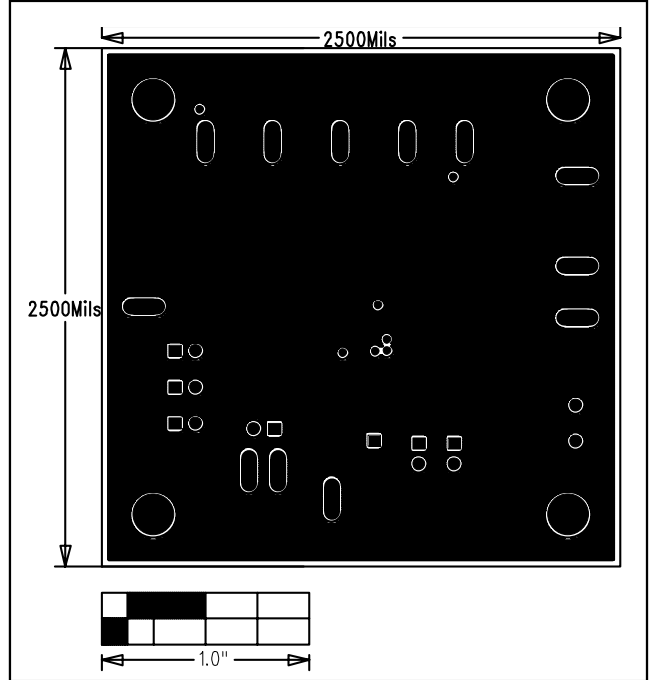

Figure 7. MAX8677A EV Kit PCB Layout—Solder Side

Maxim cannot assume responsibility for use of any circuitry other than circuitry entirely embodied in a Maxim product. No circuit patent licenses are implied. Maxim reserves the right to change the circuitry and specifications without notice at any time.

6 Maxim Integrated Products, 120 San Gabriel Drive, Sunnyvale, CA 94086 408-737-7600

© 2007 Maxim Integrated Products

MAXIM is a registered trademark of Maxim Integrated Products.