



MAX6946 Evaluation Kit/Evaluation System

General Description

The MAX6946 evaluation (EV) kit is an assembled and tested PCB that demonstrates the capabilities of the MAX6946 constant-current LED driver and digital I/O expander. The EV kit includes three RGB LEDs and one white LED that can be controlled simultaneously by the MAX6946. The MAX6947 can also be evaluated on the EV kit board by replacing the MAX6946 IC.

The MAX6946 evaluation system (EV system) includes a MAX6946 EV kit and a Maxim interface board (CMAXQUSB). The CMAXQUSB board connects to a PC's USB port and allows the transfer of I²C commands to the MAX6946 EV kit.

The CMAXQUSB board allows a PC to use its USB port to emulate an I²C 2-wire interface. Windows® 98SE/2000/XP-compatible software (which can be downloaded from www.maxim-ic.com/evkitsoftware) provides a user-friendly interface to exercise the features of the MAX6946. The program is menu driven and offers a graphical user interface (GUI) with control buttons and a status display. Order the MAX6946EVCMAXQU+ for a complete PC-based evaluation kit of the MAX6946. Order the MAX6946EVKIT+ if you already have a CMAXQUSB interface board or an I²C-compatible 2-wire interface system.

Windows is a registered trademark of Microsoft Corp.

Component Suppliers

SUPPLIER	PHONE	WEBSITE
Optek	972-323-2200	www.optekinc.com
TDK	847-803-6100	www.component.tdk.com

Note: Indicate you are using the MAX6946/MAX6947 when contacting these manufacturers.

MAX6946EVCMAXQU EV System

PART	QTY	DESCRIPTION
MAX6946EVKIT+	1	MAX6946 EV kit
CMAXQUSB+	1	Maxim interface board

MAX6946 Evaluation Kit

DESIGNATION	QTY	DESCRIPTION
C1	1	0.1µF ±10%, 6.3V X5R ceramic capacitor (0402) TDK C1005X5R0J104K
C2	0	Not installed, ceramic capacitor (0603)
C3	1	10µF ±10%, 10V X5R ceramic capacitor (0805) TDK C2012X5R1A106K

Features

- ◆ Proven PCB Layout
- ◆ Windows 98SE/2000/XP-Compatible Evaluation Software
- ◆ Three RGB LEDs and One White LED
- ◆ Access to I²C Interface Signals
- ◆ Header for Accessing to the MAX6946 10 I/O Ports
- ◆ Fully Assembled and Tested

Ordering Information

PART	TEMP RANGE*	IC PACKAGE	2-WIRE SERIAL INTERFACE TYPE
MAX6946EVKIT+	0°C to +70°C	16 TQFN-EP	User-supplied I ² C interface
MAX6946EVCMAXQU+	0°C to +70°C	16 TQFN-EP	CMAXQUSB interface board

+ Denotes a lead-free and RoHS-compliant EV kit/system.

*PCB temperature rating only.

Component List

MAX6946 Evaluation Kit

DESIGNATION	QTY	DESCRIPTION
C4	0	Not installed, ceramic capacitor (0805)
D1, D2, D3	3	RGB LEDs (2.4mm x 3.2mm) Optek OVSARGB3R8
D4	1	White LED (PLCC-2) Optek OVS9WBCR9
J1	1	2 x 10 right-angle female receptacle
J2	1	2 x 10-pin header
JU1	1	2-pin header
JU2	0	Not installed, 3-pin header
R1	1	4.7kΩ ±5% resistor (0402)
R2-R11	0	Not installed, resistors (0402)
R12, R13	0	Not installed, resistors (0603)



MAX6946 Evaluation Kit/Evaluation System

Component List (continued)

MAX6946 Evaluation Kit

DESIGNATION	QTY	DESCRIPTION
SW1	1	Momentary pushbutton switch
U1	1	Maxim: MAX6946ATE+ (16-pin TQFN 3mm x 3mm) Top Mark: AES
See jumper table for jumper settings	11	Shunts (J2, JU1)
—	1	PC Board: MAX6946 Evaluation Kit

MAX6946EVKIT Files

FILE	DESCRIPTION
INSTALL.EXE	Installs the EV kit files on your computer
MAX6946.EXE	Executes the application program
UNINST.INI	Uninstalls the EV kit software
Ftd2xx.INF	USB device driver file
TROUBLESHOOTING_USB.PDF	USB troubleshooting guide

Quick Start

Recommended Equipment

- The Maxim MAX6946EVCMAXQU evaluation system:
MAX6946 EV kit
Maxim interface board (CMAXQUSB)
USB cable (included with CMAXQUSB)
- One 5.5V to 7.0V, 300mA power supply
- One user-supplied Windows 98SE/2000/XP PC with an unused USB port

Note: In the following section(s), software-related items are identified by bolding. Text in **bold** refers to items directly from the EV kit software. Text in **bold and underline** refers to items from the Windows 98SE/2000/XP operating system.

Procedure

The MAX6946 EV kit is a fully assembled and tested surface-mount board. Follow the steps below to verify board operation. Do not enable the power supply until all connections are made.

- 1) Visit the Maxim Integrated Products website (www.maxim-ic.com/evkitsoftware) to download the

most current version of the EV kit software MAX6946Rxx.ZIP. Save the EV kit software to a temporary folder and uncompress the ZIP file.

- 2) Install the MAX6946 EV kit software on your PC by running the INSTALL.EXE program. The program files are copied and icons are created for them in the Windows **Start | Programs** menu.
- 3) Place a shunt on the 3.3V setting of jumper JU1 on the CMAXQUSB interface board.
- 4) Verify that the two switches on SW1, located on the CMAXQUSB board, are set to the ON position.
- 5) Verify that a shunt is installed across jumper JU1 on the EV kit board.
- 6) Connect the MAX6946 EV kit's 20-pin female connector (J1) to the CMAXQUSB's 20-pin male connector (P3).
- 7) Connect the 5.5V power supply between the MAX6946 EV kit's VLED and GND pads.
- 8) Enable the power supply.
- 9) Connect the USB cable from the PC to the CMAXQUSB board. A **Building Driver Database** window should pop up in addition to a **New Hardware Found** message if this is the first time the EV kit board is connected to the PC. If you do not see a window that is similar to the one described above after 30 seconds, try removing the USB cable from the CMAXQUSB and reconnect it. Administrator privileges are required to install the USB device driver on Windows 2000 and XP. Refer to the document TROUBLESHOOTING_USB.PDF included with the software if you have any problems during this step.
- 10) Follow the directions of the **Add New Hardware Wizard** to install the USB device driver. Choose the **Search for the best driver for your device** option. Specify the location of the device driver to be **C:\Program Files\MAX6946** (default installation directory) using the **Browse** button.
- 11) Start the MAX6946 EV kit software by opening its icon in the **Start | Programs** menu. The application window shown in Figure 1 appears, and the software connects to the CMAXQUSB after a few seconds.
- 12) Select the **Run Enable:** drop box located in the **Global Settings** group box and select **Run Mode**.
- 13) Select the **Constant-Current Sink** radio button in the **P0-P9 Configuration** group box to illuminate all of the LEDs on the EV kit.

MAX6946 Evaluation Kit/Evaluation System

Detailed Description of Hardware

MAX6946 EV System

The MAX6946 EV system (MAX6946EVCMAXQU) is a complete 10-port, constant-current LED driver and I/O expander system, consisting of a MAX6946 EV kit and the Maxim interface board (CMAXQUSB).

CMAXQUSB

The CMAXQUSB is a Maxim interface board that provides an I²C interface bus to demonstrate various Maxim devices. Maxim reserves the right to change the implementation of this module at any time with no advance notice.

MAX6946 EV Kit

The MAX6946 EV kit board provides a proven layout for evaluating the MAX6946 constant-current LED driver/10-port I/O expander IC and can be obtained separately without the CMAXQUSB. The 10 I/O ports can be configured as logic inputs, open-drain logic outputs, constant-current sink outputs, or any combination of the above. The EV kit includes three RGB LEDs (D1, D2, and D3) and one white LED (D4). These LEDs can be enabled and the current through each LED can be controlled using the MAX6946 EV kit software (see the *Detailed Description of Software* section).

The MAX6946 EV kit includes PCB pads (R2–R11) on the bottom side of the PCB that can be used to add pullup resistors at each of the MAX6946's P0–P9 ports to operate the EV kit in logic input/output mode.

Power Supplies

The MAX6946 EV kit requires a 2.25V to 3.6V power supply connected to the VDD and GND PC pads for normal operation. The EV kit can also use the CMAXQUSB interface board's 3.3V power source by installing a shunt across jumper JU1 on the MAX6946 EV kit and configuring the CMAXQUSB interface board VDD. Set jumper JU1 in the CMAXQUSB to 3.3V. See Table 1 for EV kit jumper JU1 configuration. **Note:** Insure that all of the data sheet absolute maximum specifications are not violated when operating the MAX6946 EV kit.

The EV kit also requires a 5.5V to 7V voltage source connected to the VLED and GND pads to power the LEDs when operating the EV kit in input/current-sink mode. Use voltages from 2.25V to 7V to provide a pullup voltage during logic output/input operation.

Table 1. Voltage Source Selection (Jumper JU1)

SHUNT POSITION	EV KIT FUNCTION
Installed*	Power supplied from the CMAXQUSB. Note: Verify that the CMAXQUSB JU1 voltage is configured to 3.3V.
Not installed	User-supplied power source required at the EV kit VDD and GND pads.

*Default configuration.

RST Input

The EV kit features a pushbutton switch, SW1, that connects the MAX6946 RST pin to ground. Push and hold the pushbutton switch to connect the RST pin to ground. Refer to the *RST Input* section in the MAX6946/MAX6947 IC data sheet to use this RST feature.

I/O Ports

The MAX6946 EV kit includes three RGB LEDs (D1, D2, and D3) and one white LED (D4) connected to the 10 I/O ports through shunts installed on header J2. The LEDs are enabled by configuring the respective port on the MAX6946 to constant-current static output, constant-current PWM output, or low-logic output mode. For logic operation at each port, remove the shunts on header J2, install 10kΩ pullup resistors on PC pads R2–R11, and configure the ports for logic outputs or inputs.

I²C Clock and Data Inputs

The MAX6946 EV kit features a 2 x 10 right-angle header receptacle (J1) to interface with the CMAXQUSB interface board. Pin J1-7 connects to the MAX6946 clock pin (SCL) and pin J1-3 connects to the data pin (SDA) for I²C-compatible communications. Slide both SW1 dip switches on the CMAXQUSB interface board to the ON position to connect pullup resistors to the SCL and SDA signal lines for proper I²C communication.

The clock and data input pins can also be accessed at the SCL and SDA EV kit PCB pads, respectively. An external I²C-compatible controller can be connected to the SCL, SDA, and GND PCB pads to communicate with the MAX6946 IC. If the external device does not have pullup resistors on the clock and data lines, 2.4kΩ (typ) pullup surface-mount resistors (0603 size) must be installed on R12 and R13 PCB pads for proper I²C communication. The GND PCB pad must also be connected to the external I²C controller.

Evaluate: MAX6946/MAX6947

MAX6946 Evaluation Kit/Evaluation System

Evaluating the MAX6947

The MAX6946 EV kit PCB can also be used to evaluate the MAX6947 10-port expander. Remove the MAX6946 IC (U1) and replace it with the MAX6947 IC. The MAX6947 is pin and function compatible with the MAX6946, with the exception of pin 12. When evaluating the MAX6947, the OSC PC pad on the EV kit can be used to access the AD0 pin. Refer to the MAX6946/MAX6947 IC data sheet for a complete description of part-to-part differences. Install a 3-pin 0.1in header at JU2 on the EV kit board and use a shunt to configure the MAX6947 address. See Table 2 for jumper JU2 configuration.

Table 2. MAX6947 Slave Address Selection (Jumper JU2)

SHUNT POSITION	AD0 PIN	MAX6947 SLAVE ADDRESS
1-2	Connected to VDD	0x40
2-3	Connected to GND	0x48

Detailed Description of Software

Note: Words in boldface are user-selectable features in the software.

Graphical User Interface

The user interface (shown in Figure 1) is simple to operate. Use the computer mouse buttons or press the Tab key to navigate through the GUI controls. The correct I²C write operation is generated to update the internal registers of the MAX6946 when any of these controls are used.

The software divides EV kit functions into group boxes. The **Interface** group box indicates the **Device Address**, **I²C Bus Speed**, EV kit **Status**, and the last operation **Command Sent** and **Data Sent** indicators. This data is used to confirm proper device operation. The **Global Settings** box allows the user to program the configuration register, configure the global settings for the 10 ports, and read the ports. The tabs on the GUI are used to configure individual or groups of ports.

The MAX6946 EV kit software features additional functions to simplify operation. **Automatic Diagnostics** continually probe the interface board and the MAX6946 EV kit to make sure that all communications are maintained and that all devices are working. These functions will create some activity on the I²C bus. The **Silence I²C Activity** checkbox reduces I²C bus activity so triggering of an oscilloscope while communicating to the MAX6946 EV kit is made easy. The **Factory Reset** button programs the EV kit to the MAX6946 initial power-up conditions.

MAX6946 Evaluation Kit/Evaluation System

Evaluate: MAX6946/MAX6947

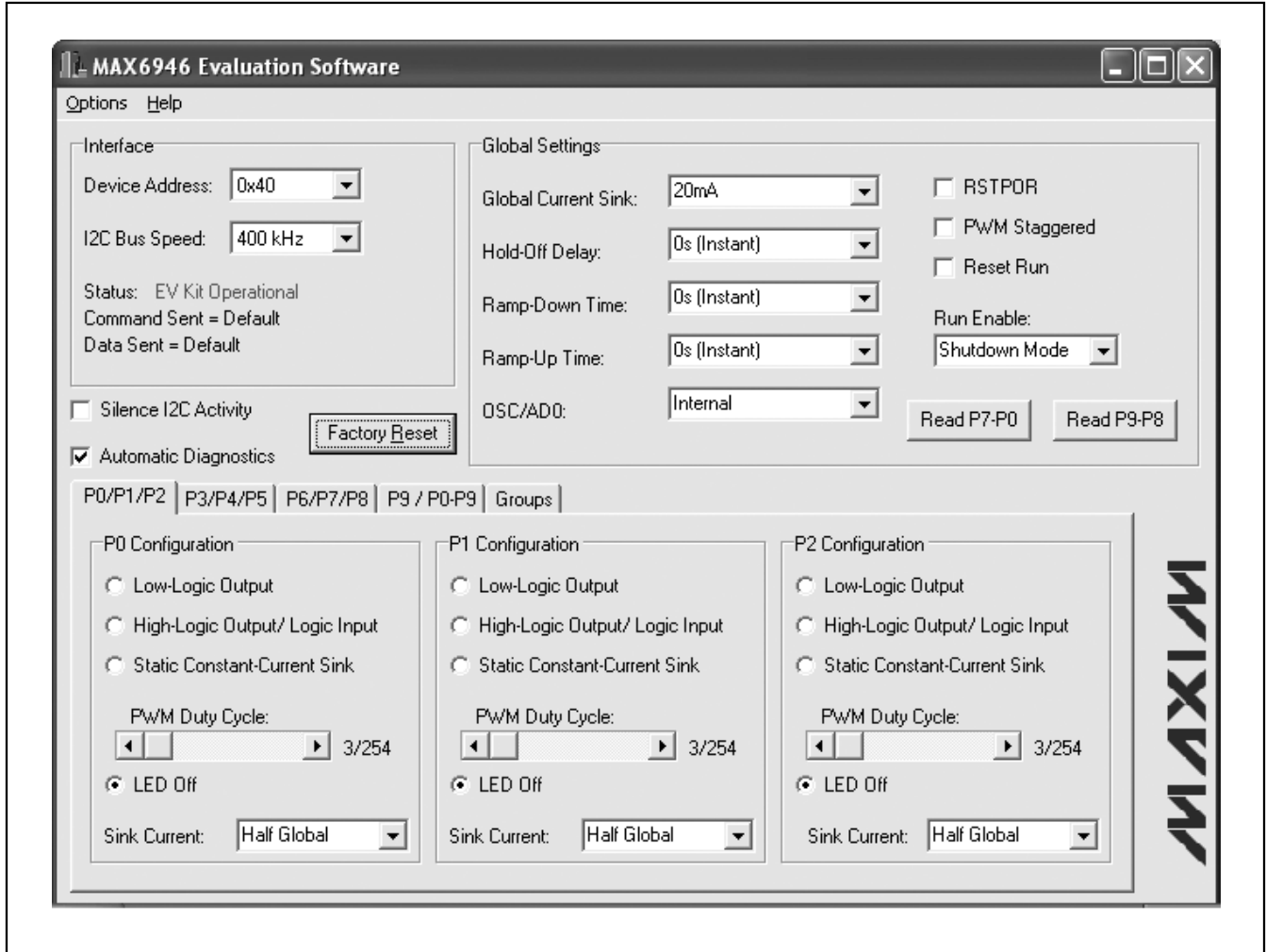

Figure 1. MAX6946 EV Kit Software Graphical User Interface (GUI)

Software Connection to CMAXQUSB

The MAX6946 EV kit software automatically searches for the CMAXQUSB interface board and MAX6946 EV kit during startup. The **Status** indicator shows if the interface board and the MAX6946 EV kit are operational. If the interface board is not found, verify that the command module and the USB cable are connected properly, power is applied to the EV kit, and select the YES button on the retry-connection message box.

The nonfunctional GUI can be viewed by selecting the NO button on the retry-connection message box when attempting to start the software without the CMAXQUSB interface board being connected. Restart the software with the interface board and EV kit properly connected for normal operation.

Interface

The MAX6946 EV kit software automatically searches for the MAX6946 during startup. If the software finds the MAX6946, the **Status** indicator shows that the MAX6946 is operational. If the MAX6946 is not found, the **Status** indicator shows that the MAX6946 was not found and the **Device Address** is set to "??". Select the **Auto Detect** option from the **Device Address** combo box to search for the device address.

Use the **I2C Bus Speed** combo box to set the serial bus speed to 400kHz or 100kHz.

Global Settings

The **Global Settings** group box includes controls to configure the **Global Current Sink** from 2.5mA to

MAX6946 Evaluation Kit/Evaluation System

20mA and the **Hold-Off Delay**, **Ramp-Down Time**, and **Ramp-Up Time** from 0 to 4s. The other configuration register bits can be programmed by configuring the **OSC/AD0**, **RSTPOR**, **PWM Staggered**, **Reset Run**, and **Run Enable** GUI controls. The **Read P7-P0** and **Read P9-P8** buttons can be used to read the logical state of the MAX6946 P7–P0 and P9 to P8 pins, respectively. Refer to the MAX6946/MAX6947 IC data sheet for a detailed description of each of these functions. **Note:** During **Read P7-P0** and **Read P9-P8** operations, the software automatically changes the r/w bit in the address from 0 to 1 for proper I²C read operation.

Configuring the I/O Ports

The GUI tabs allow the user to configure the 10 I/O ports individually or in groups. Once a port(s) tab has been selected, the **P_ Configuration** group box allows the user to configure the port as a **Low-Logic Output**, **High-Logic Output/ Logic Input**, **Static Constant-Current Sink**, constant-current PWM output (**PWM Duty Cycle** slide bar), or disable the LED(s) (**LED Off**). Individual port **Sink Current** can be configured to half or full of the global current setting (**Global Current Sink**). Configuring the I/O ports to **Low-Logic Output** turns on the LEDs without regulating the LED current at the respective port. Use the mouse or keyboard left/right arrows to move the **PWM Duty Cycle** slide bar from left to right to dim or brighten the LED(s). Refer to the MAX6946/MAX6947 IC data sheet for a detailed description of each of these registers. For true logic input or output configuration of each port, remove the shunts on header J2, install pullup resistors on PC pads R2–R11, and use the software to configure the ports for logic outputs or inputs. Refer to the *I/O Ports* section in the MAX6946/MAX6947 IC data sheet for further details.

Simple I²C Commands

There are two methods for communicating with the MAX6946; through the normal user-interface panel (Figure 1) or by using low-level I²C commands available through the **2-wire interface** diagnostics (Figure

2) item from the main program's **Options** menu. A window is displayed that allows I²C operations, such as read byte and write byte. To stop normal user-interface execution so that it does not override the manually set values, turn off the update timer by unchecking the **Automatic Diagnostics** checkbox in the MAX6946 main program.

The I²C dialog boxes accept numeric data in binary, decimal, or hexadecimal. Hexadecimal numbers must be prefixed by \$ or 0x. Binary numbers must be exactly eight digits of 0s and 1s. See Figure 2 for an example using the **2-wire interface** diagnostics tool.

Note: When using low-level I²C commands, the GUI interface is no longer synchronized and will not reflect the IC register settings.

General Troubleshooting

Problem: software reports it cannot find the board.

- Is the CMAXQUSB interface board power LED (LED1) lit?
- Is the USB communications cable connected?
- Has windows plug-and-play detected the board? Bring up **Control Panel System | Device Manager**, and look at what device nodes are indicated for USB. If there is an “unknown device” node attached to the USB, delete it—this forces plug-and-play to try again.

Problem: Unable to find DUT (device-under-test).

- Is power connected to the MAX6946 EV kit?
- Are the SCL and SDA signals pulled up to VDD through appropriate resistors (2.4k Ω typ)? The CMAXQUSB interface board dip-switch SW1 enables the on-board resistors. There must be pullup resistors somewhere on the I²C bus.
- If using jumper wires to connect to the I²C bus, could the SCL and SDA signals be swapped? Could the GND ground return be missing?

MAX6946 Evaluation Kit/Evaluation System

Evaluate: MAX6946/MAX6947

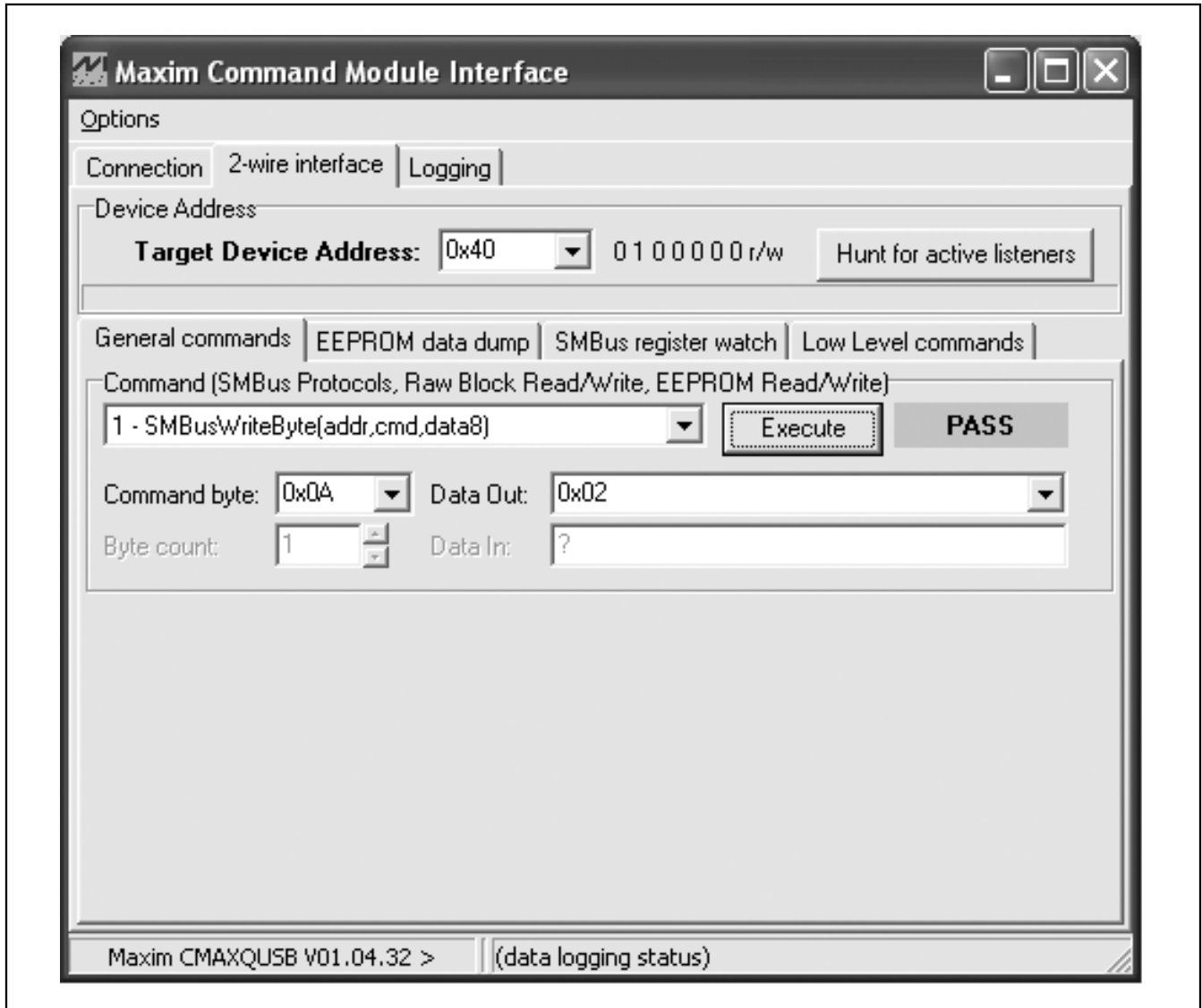

Figure 2. 2-Wire Interface Utility. The above example shows a simple SMBusWriteByte operation using the included 2-wire interface diagnostics tool. In this example, the software is writing 0x02 data to register address 0x0A (write to ports P0–P9) of the device with a device address of 0x40. The above data sequence sets the MAX6946 10 ports to constant-current static sink output.

MAX6946 Evaluation Kit/Evaluation System

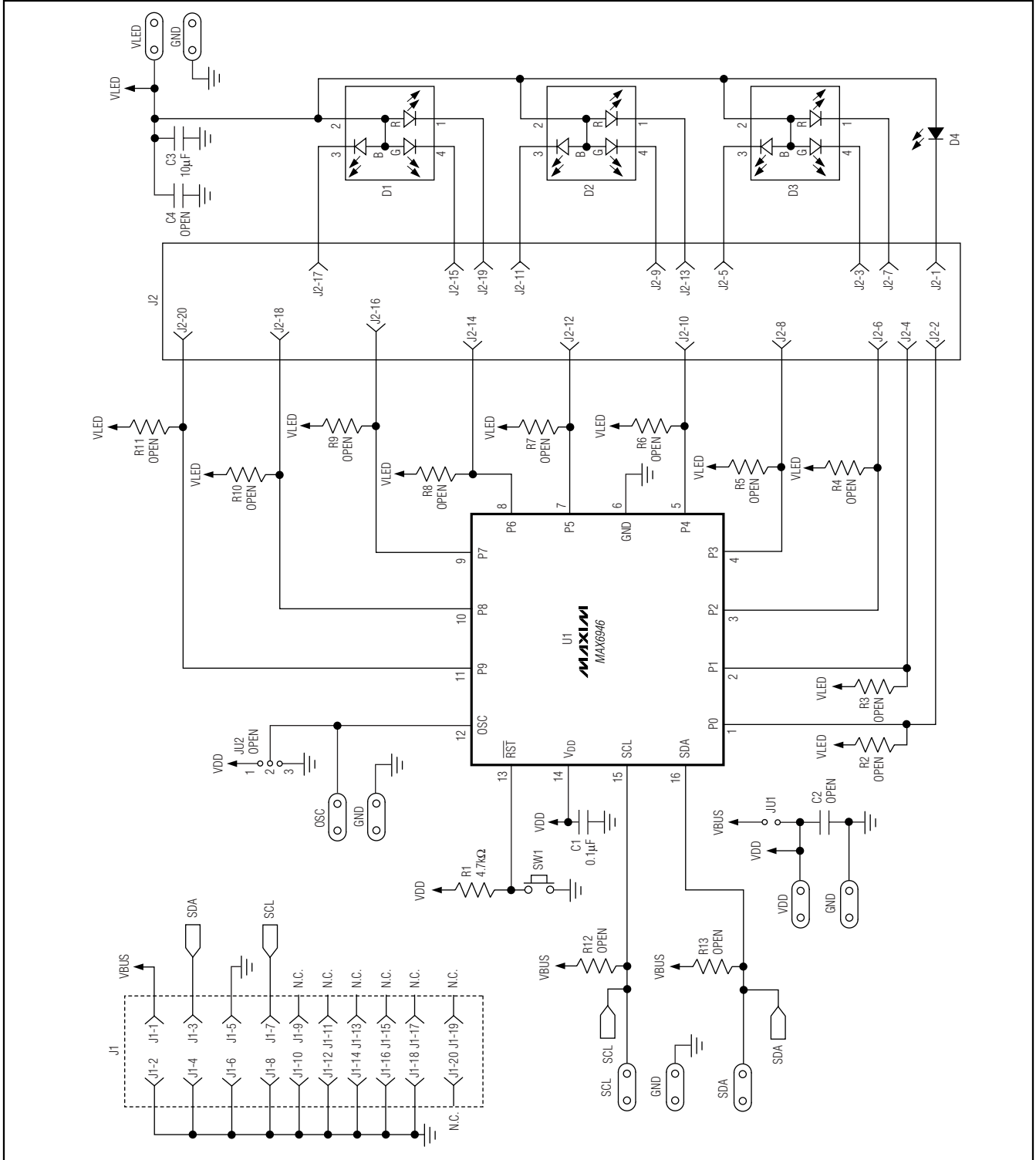

Figure3. MAX6946 EV Kit Schematic

MAX6946 Evaluation Kit/Evaluation System

Evaluate: MAX6946/MAX6947

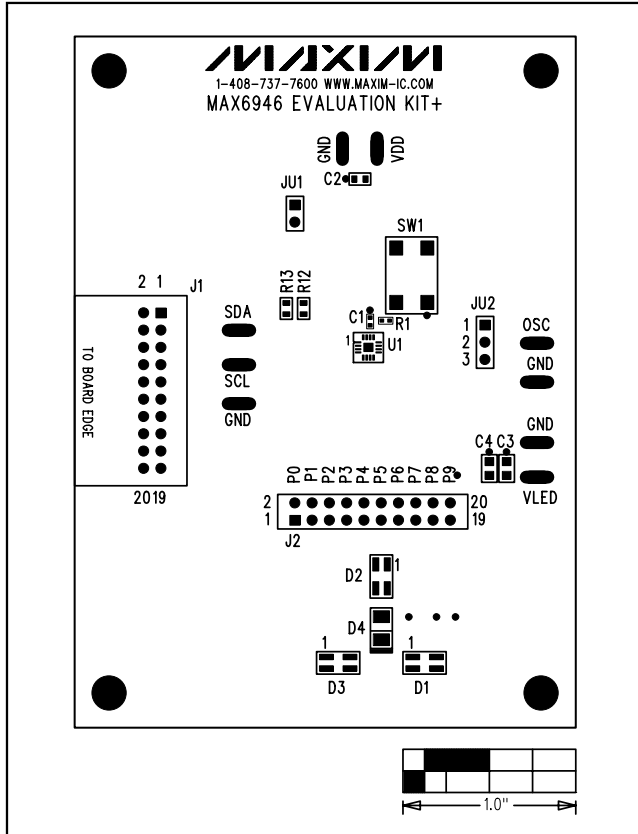

Figure 4. MAX6946 EV Kit Component Placement Guide—Component Side

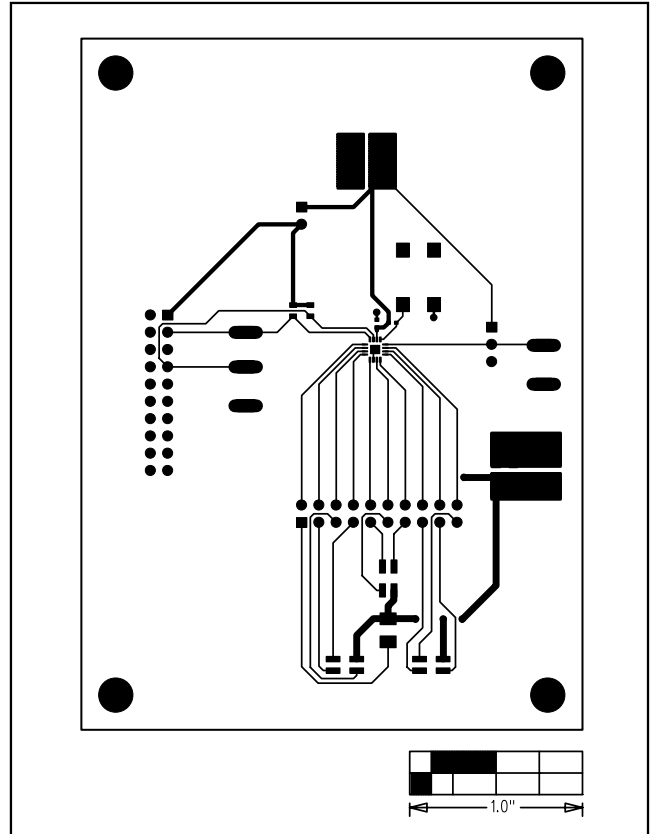

Figure 5. MAX6946 EV Kit PCB Layout—Component Side

MAX6946 Evaluation Kit/Evaluation System

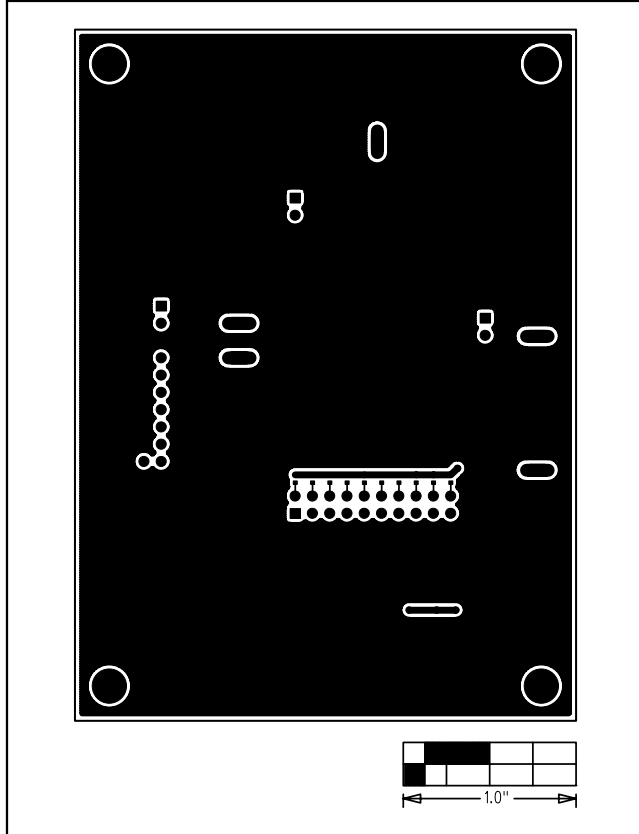

Figure 6. MAX6946 EV Kit PCB Layout—Solder Side

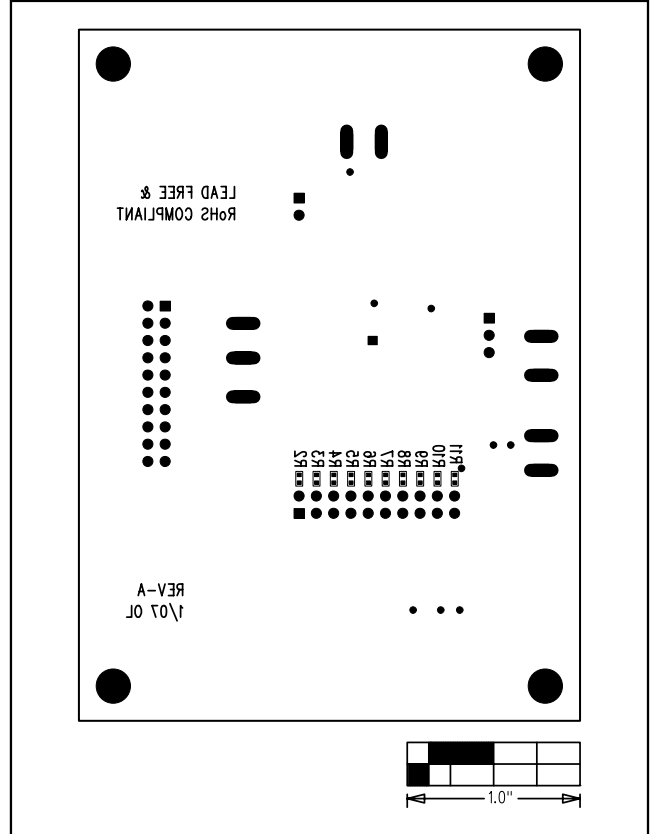

Figure 7. MAX6946 EV Kit Component Placement Guide—Solder Side

Maxim cannot assume responsibility for use of any circuitry other than circuitry entirely embodied in a Maxim product. No circuit patent licenses are implied. Maxim reserves the right to change the circuitry and specifications without notice at any time.

10 _____ **Maxim Integrated Products, 120 San Gabriel Drive, Sunnyvale, CA 94086 408-737-7600**