



# MAX5854 Evaluation Kit

## General Description

The MAX5854 evaluation kit (EV kit) is a fully assembled and tested circuit board that contains all the components necessary to evaluate the performance of the MAX5854 digital-to-analog converter (DAC). The MAX5854 is a dual, 10-bit parallel, 165Msps DAC that integrates a 1.24V voltage reference and provides a differential current output. The EV kit operates with CMOS-compatible data inputs, a differential or single-ended clock input, and 3V power supplies for simple board operation.

The MAX5854 EV kit can also be used to evaluate the MAX5853 (80Msps) DAC.

## Features

- ◆ **Fast Evaluation and Performance Testing**
- ◆ **CMOS Compatible**
- ◆ **SMA Coaxial Connectors for Clock Inputs, Clock Output, and Analog Output**
- ◆ **50Ω Matched Clock Input and Analog Output Signal Lines**
- ◆ **Single-Ended to Differential Clock Signal-Conversion Circuitry**
- ◆ **Differential Current Output to Single-Ended Voltage Signal Output Conversion Circuitry**
- ◆ **Full-Scale Current Output Configured for 20mA**
- ◆ **Fully Assembled and Tested**
- ◆ **Also Evaluates the 80Msps MAX5853**

## Ordering Information

PART	TEMP RANGE	IC PACKAGE
MAX5854EVKIT	0°C to +70°C	40 Thin QFN-EP

EP = Exposed pad.

## Component List

DESIGNATION	QTY	DESCRIPTION
C1-C6	6	0.1μF ±10%, 6.3V X5R ceramic capacitors (0201) TDK C0603X5R0J104K or Murata GRM033R60J104K
C7-C13	7	0.1μF ±10%, 10V X5R ceramic capacitors (0402) TDK C1005X5R1A104K or Taiyo Yuden LMK105BJ104KV
C14, C15	2	5pF ±0.25pF, 50V C0G ceramic capacitors (0603) TDK C1608C0G1H050C
C16-C21	6	1μF ±10%, 10V X5R ceramic capacitors (0603) TDK C1608X5R1A105K
C22-C27	6	10μF ±10%, 10V tantalum capacitors (A) AVX TAJA106K010R or Kemet T494A106K010AS
L1, L2, L3	3	Ferrite bead inductors, 115Ω at 100MHz (1812) Panasonic EXC-CL4532U1
R1-R7, R16	8	49.9Ω ±1% resistors (0603)
R8, R12	0	Not installed, resistor (0603)
R9	1	1.91kΩ ±1% resistor (0603)

DESIGNATION	QTY	DESCRIPTION
R10	1	10kΩ ±5% resistor (0603)
R11, R13, R14, R15	4	1kΩ ±5% resistors (0603)
R17, R18	2	100Ω ±1% resistors (0603)
T1	1	Transformer (1:1) Mini-Circuits ADTL1-12
T2, T3, T4	3	Transformers (1:1) Coilcraft TTWB3010-1
U1	1	MAX5854ETL (40-pin thin QFN-EP, 6mm x 6mm)
U2	1	Quadruple bus buffer gate with tri-state outputs (14-pin TSSOP-PW) Texas Instruments SN74ALVC125PWR
CLKD, CLKIN, CLKOUT, OUTA, OUTB	5	SMA PC-mount vertical connectors
J1	1	2 x 21 pin surface-mount header Samtec TSM-121-02-S-MT
JU1-JU9	9	2-pin headers
None	9	Shunts (JU1-JU9)
None	1	MAX5854 PC board

Evaluates: MAX5854/MAX5853



# MAX5854 Evaluation Kit

## Component Suppliers

SUPPLIER	PHONE	FAX	WEBSITE
AVX	843-946-0238	843-626-3123	www.avxcorp.com
Coilcraft	847-639-6400	847-639-1469	www.coilcraft.com
Kemet	864-963-6300	864-963-6322	www.kemet.com
Mini-Circuits	718-934-4500	718-934-7092	www.minicircuits.com
Murata	770-436-1300	770-436-3030	www.murata.com
Panasonic	714-373-7366	714-737-7323	www.panasonic.com
Samtec	800-726-8329	812-948-5047	www.samtec.com
Taiyo Yuden	800-348-2496	847-925-0899	www.t-yuden.com
TDK	847- 803-6100	847-390-4405	www.component.tdk.com

**Note:** Please indicate that you are using the MAX5854 when contacting these component suppliers.

## Quick Start

Recommended equipment:

- Three 3VDC power supplies
- Two signal generators with low-phase noise and low jitter for clock input (e.g., HP 8662A)
- One dual 10-bit digital pattern generator for data inputs (e.g., Tektronix DG2020A)
- One spectrum analyzer (e.g., HP 8560E)
- One voltmeter

The MAX5854 EV kit is a fully assembled and tested surface-mount board. Follow the steps below for board operation. **Do not turn on power supplies or enable signal generators/pattern until all connections are completed:**

- 1) Verify that shunts are not installed across jumpers JU1, JU2, and JU3.
- 2) Verify that shunts are installed across jumpers JU4, JU5, JU6, JU7, JU8, and JU9.
- 3) Synchronize the digital pattern generator (DG2020A) with the clock signal generator (HP 8662A).
- 4) Connect the clock signal generator to the CLKD SMA connector on the EV kit.
- 5) Verify that the digital pattern generator is programmed for valid CMOS output voltage levels.
- 6) Connect the digital signal generator output to the J1 input header connector on the EV kit board. The input header pins are labeled for proper connection to the digital pattern generator.
- 7) Connect the spectrum analyzer to channel A OUTA output SMA connector or to channel B output OUTB SMA connector.

- 8) Connect a 3V, 100mA power supply to AVDDIN. Connect the ground terminal of this supply to AGND.
- 9) Connect a 3V, 100mA power supply to DVDDIN. Connect the ground terminal of this supply to DGND.
- 10) Connect a 3V, 100mA power supply to CVDDIN. Connect the ground terminal of this supply to CGND.
- 11) Turn on all three power supplies.
- 12) Enable the clock signal generator (HP 8662A) and the digital pattern generator.
- 13) Set the clock signal generator output power to 10dBm and the frequency ( $f_{CLK}$ ) to less than or equal to 165MHz.
- 14) Use the spectrum analyzer to view the MAX5854 output spectrum or view the output waveform using an oscilloscope on the OUTA or OUTB outputs.

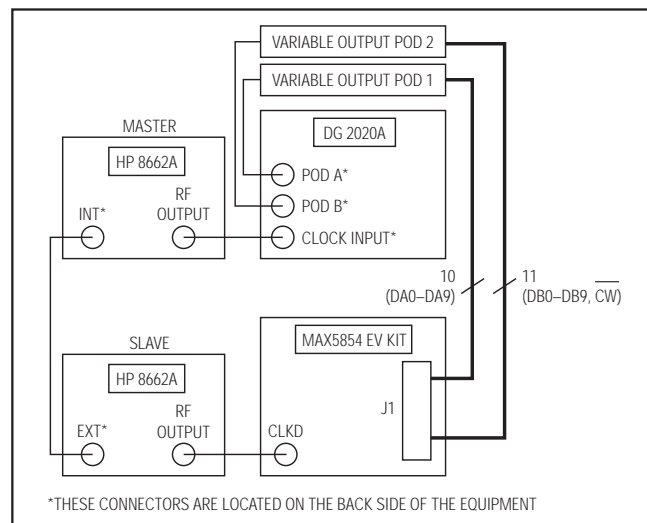

Figure 1. MAX5854 EV Kit Quick-Start Setup

# MAX5854 Evaluation Kit

Evaluates: MAX5854/MAX5853

## Detailed Description

The MAX5854 EV kit is designed to simplify the evaluation of the MAX5854 dual 10-bit, 165Msps, current output DAC. The MAX5854 operates with CMOS-compatible data inputs, a differential or single-ended clock input signal, an internal 1.24V reference voltage, and a 3V power supply.

The MAX5854 EV kit provides header connector J1 to easily interface with a pattern generator, circuitry that converts the differential current outputs to single-ended voltage signals, and circuitry to convert a user-supplied single-ended clock signal to a differential clock signal. The EV kit can operate from a single 3V power supply but also supports the use of three separate 3V power supplies. Dividing the circuit into digital, analog, and clock planes improves dynamic performance.

### Power Supplies

The MAX5854 EV kit can operate from a single 3V power supply connected to the DVDDIN, AVDDIN, CVDDIN input power pads, and their respective ground pads for simple board operation. However, three separate 3V power supplies are recommended for optimum dynamic performance. The EV kit board layout is divided into three sections: digital, analog, and clock. Using separate power supplies for each section reduces crosstalk noise and improves the integrity of the output signal. When using separate power supplies, connect a power supply across the DVDDIN and DGND PC board pads (digital), across the CVDDIN and CGND PC board pads (clock), and across the AVDDIN and AGND PC board pads (analog) on the EV kit.

### CMOS Digital Input Data

The MAX5854 EV kit provides one 0.1in 2 x 21 header (J1) to interface a dual 10-bit CMOS pattern generator to the EV kit. The header data pins are labeled on the PC board with their appropriate data bit designation for channel A and channel B. Use the labels on the EV kit to match the data bits from the pattern generator to the corresponding data pins on header J1. The input data is latched on the rising edge of the clock signal.

### DAC Programming

The MAX5854 can be programmed to operate in different modes by writing a control word through the channel A data port. Gain matching, interleaved data mode,

internal or external reference, idle mode, and power-down are functions that are programmable. On power-up, the MAX5854 is automatically configured with the internal reference enabled, the interleaved data mode disabled, DAC enabled and fully operational, and a gain of 0dB for channel A. Refer to the MAX5854 data sheet, *Programming the DAC* section for additional programming details.

### Clock Signal

The MAX5854 operates with a single-ended CMOS or a differential clock input signal. However, the EV kit board only requires one external single-ended clock signal to evaluate the two clock modes. The EV kit circuit provides connectors that connect a single-ended signal directly to the DAC and circuitry that converts a single-ended clock signal to a differential clock signal.

For single-ended clock mode, remove the shunt from jumper JU9, install shunts on jumpers JU1, JU2, and JU3, and connect the clock signal to the CLKIN SMA connector. The clock signal connected to CLKIN input has to meet the CMOS-level requirements. The clock signal speed can be set up to 165MHz.

For differential clock mode, connect a shunt on jumper JU9, remove the shunts on jumpers JU1, JU2, and JU3, and connect the single-ended signal to the CLKD SMA connector. The clock signal can be either a sine or a square wave. A signal amplitude with a 1V<sub>p-p</sub> (4dBm) minimum is recommended. In differential clock mode, a single-ended clock signal is available at the CLKOUT SMA connector and can be used to synchronize the input data signals. See Table 1 for the clock input configuration.

**Table 1. Input Clock Configuration**

JU1, JU2, AND JU3 SHUNTS POSITION	JU9 SHUNT POSITION	EV KIT FUNCTION
Installed	Not installed	Single-ended input clock signal enabled; connect single-ended clock to CLKIN
Not installed	Installed	Differential input clock signal enabled; connect single-ended clock to CLKD, clock signal available at CLKOUT

# MAX5854 Evaluation Kit

## Reference Voltage

The MAX5854 requires a reference voltage to set the full-scale output current. The MAX5854 integrates a stable on-chip bandgap reference of 1.24V that is used by default during initial power-up. The internal reference can be disabled by writing the appropriate control word to channel A inputs. An external voltage reference must be connected to the REFO PC board pad when the internal voltage reference is disabled.

## Full-Scale Current

The MAX5854 requires an external resistor to set the full-scale output current. The MAX5854 EV kit full-scale current is set to 20mA with resistor R9. Replace resistor R9 to adjust the full-scale output current. Refer to the *Internal Reference and Control Amplifier* section in the MAX5854 data sheet to select different values for resistor R9.

## Differential Outputs

The MAX5854 outputs are configured for differential mode to achieve the best dynamic performance. Connect shunts across jumpers JU5, JU6, JU7, and JU8 to convert the differential signals to single-ended signals. Output transformers T3 and T4 convert the differential DAC output signals to single-ended signals that are available at the OUTA and OUTB SMA connectors. The resistor networks at the DAC outputs are configured in such a way that the output impedance seen at SMA connectors OUTA and OUTB is equal to 50Ω. When outputs OUTA and OUTB are terminated with 50Ω external loads, the full-scale output signal level is equal to -2dBm. The shunt on jumper JU4 should always be installed, unless it is required to shift the common-mode voltage of the DAC outputs. To evaluate the MAX5854 dynamic performance with increased output common-mode voltage, remove the shunt from jumper JU4 and connect a DC voltage source across the jumper. The DC source should be able to sink 45mA of current.

To evaluate the converter's single-ended outputs, remove the shunts from jumpers JU5, JU6, JU7, and JU8. Then probe the output signals between the jumper pins connected to the DAC outputs and the provided ground pads. In single-ended configuration, the DAC output signal amplitude is equal to 1V<sub>p-p</sub> at each of the outputs. See Table 2 for analog output signal configuration.

**Table 2. Analog Output Configuration**

JU5, JU6, JU7, AND JU8 SHUNTS POSITION	EV KIT FUNCTION
Installed	Differential analog output signals converted to single-ended signals; output signals available at OUTA and OUTB.
Not installed	The output signals can be differentially measured at jumpers JU5 and JU6 for channel A output, and jumpers JU7 and JU8 for channel B output.

## Evaluating the MAX5853

The MAX5854 EV kit can be used to evaluate the MAX5853. The MAX5853 is a 10-bit DAC with a maximum conversion rate of 80Msps. The MAX5853 is pin compatible with the MAX5854. Replace the MAX5854 (U1) with the MAX5853 to evaluate it.

## Board Layout

The MAX5854 EV kit is a four-layer PC board design optimized for high-speed signals. All high-speed signal lines are routed through 50Ω impedance-matched transmission lines. The length of these 50Ω transmission lines is matched to within 40 mils (1mm) to minimize layout-dependent data skew. The PC board layout separates the digital, analog, and clock sections of the circuit for optimum dynamic performance.

# MAX5854 Evaluation Kit

Evaluates: MAX5854/MAX5853

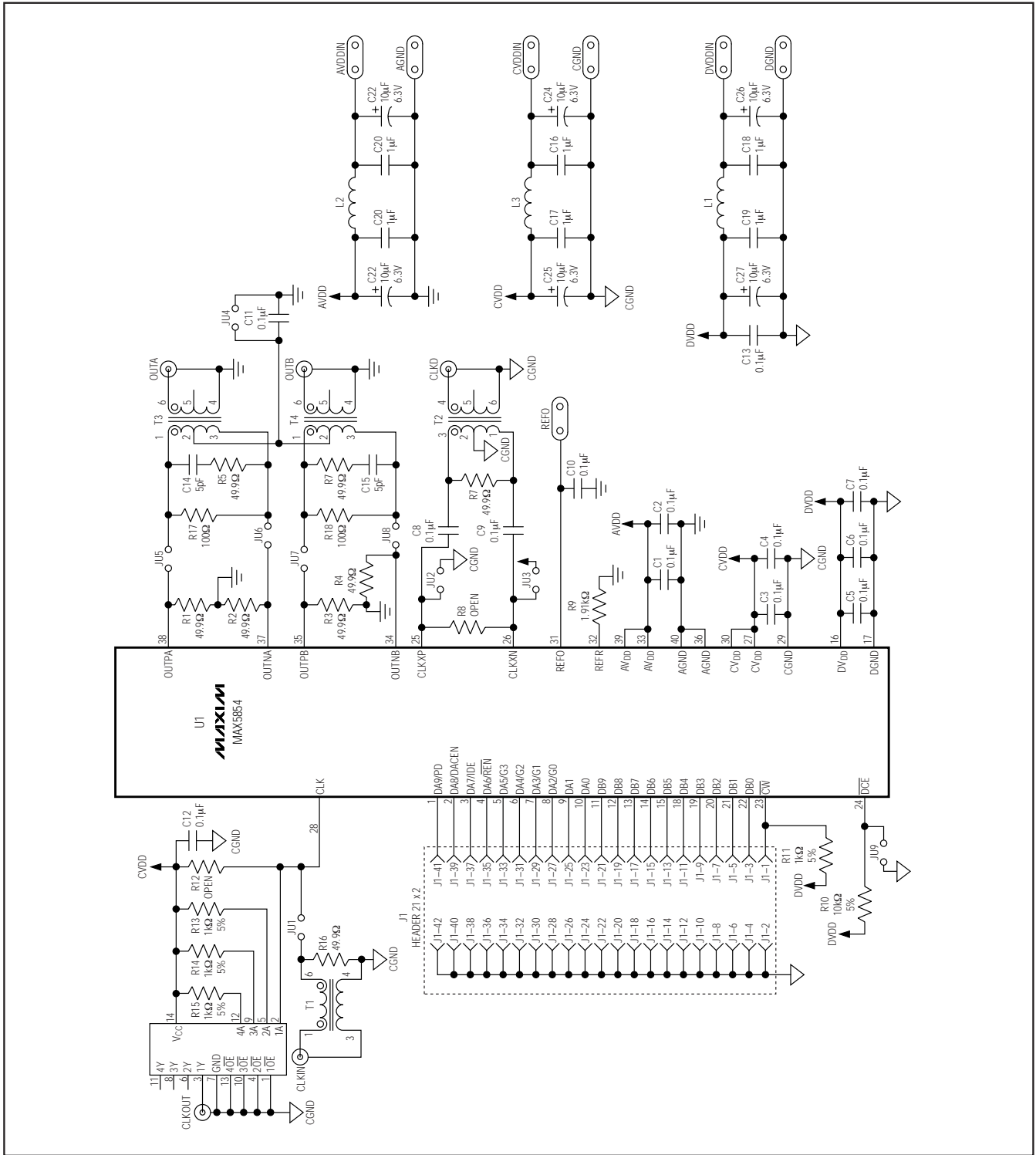

Figure 2. MAX5854 EV Kit Schematic

# MAX5854 Evaluation Kit

Evaluates: MAX5854/MAX5853

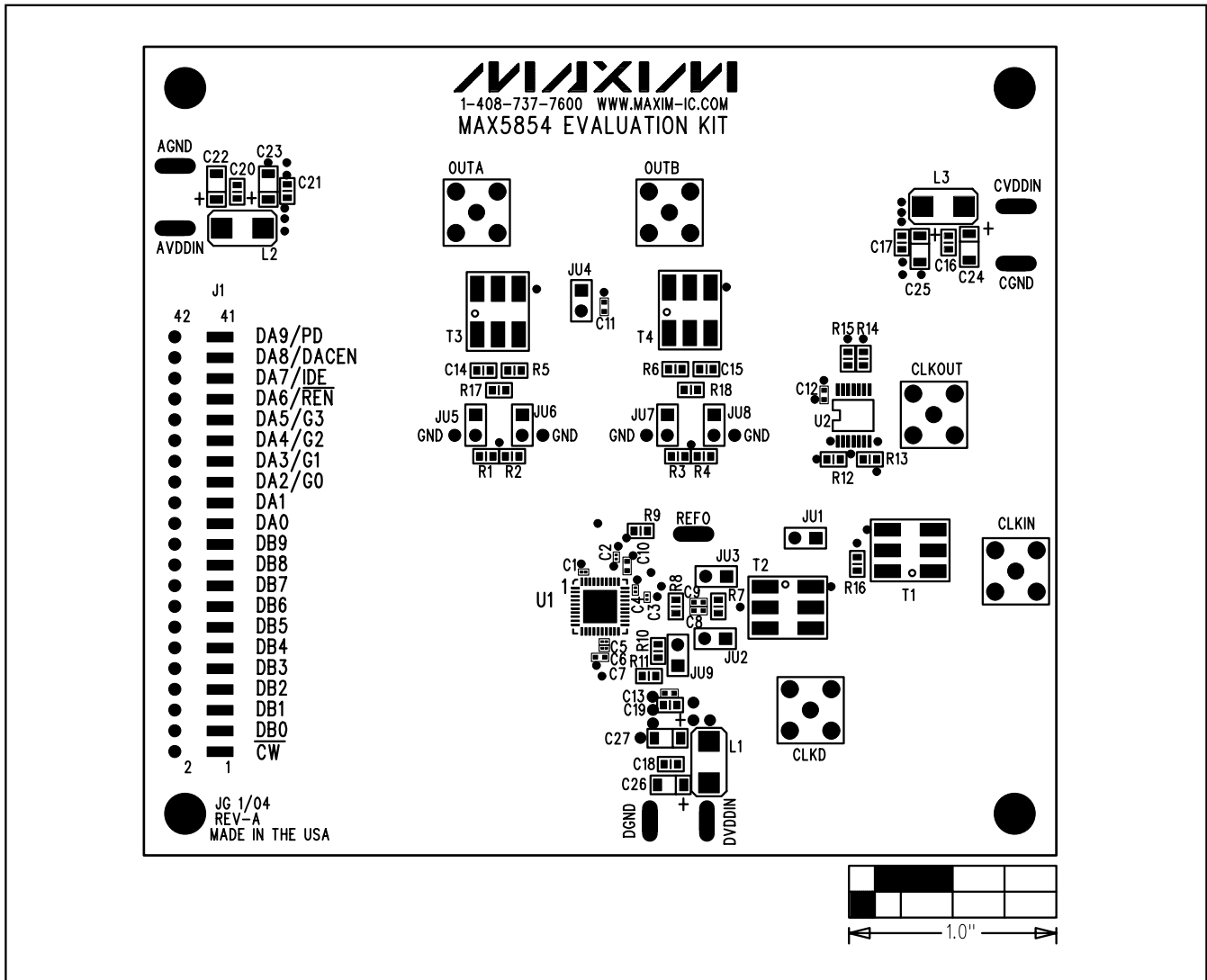

Figure 3. MAX5854 EV Kit Component Placement Guide—Component Side

# MAX5854 Evaluation Kit

Evaluates: MAX5854/MAX5853

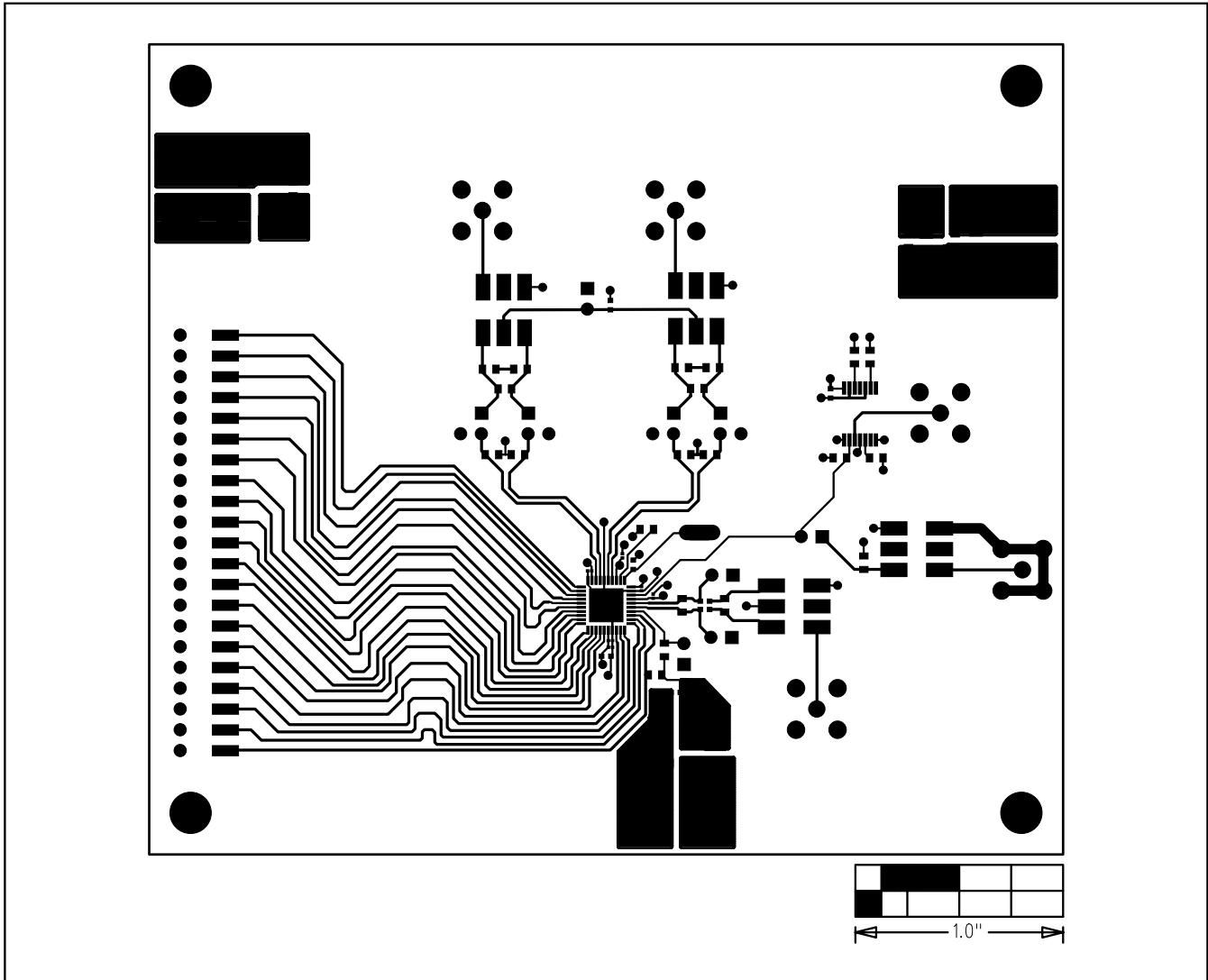

Figure 4. MAX5854 EV Kit PC Board Layout—Component Side (Layer 1)

# MAX5854 Evaluation Kit

Evaluates: MAX5854/MAX5853

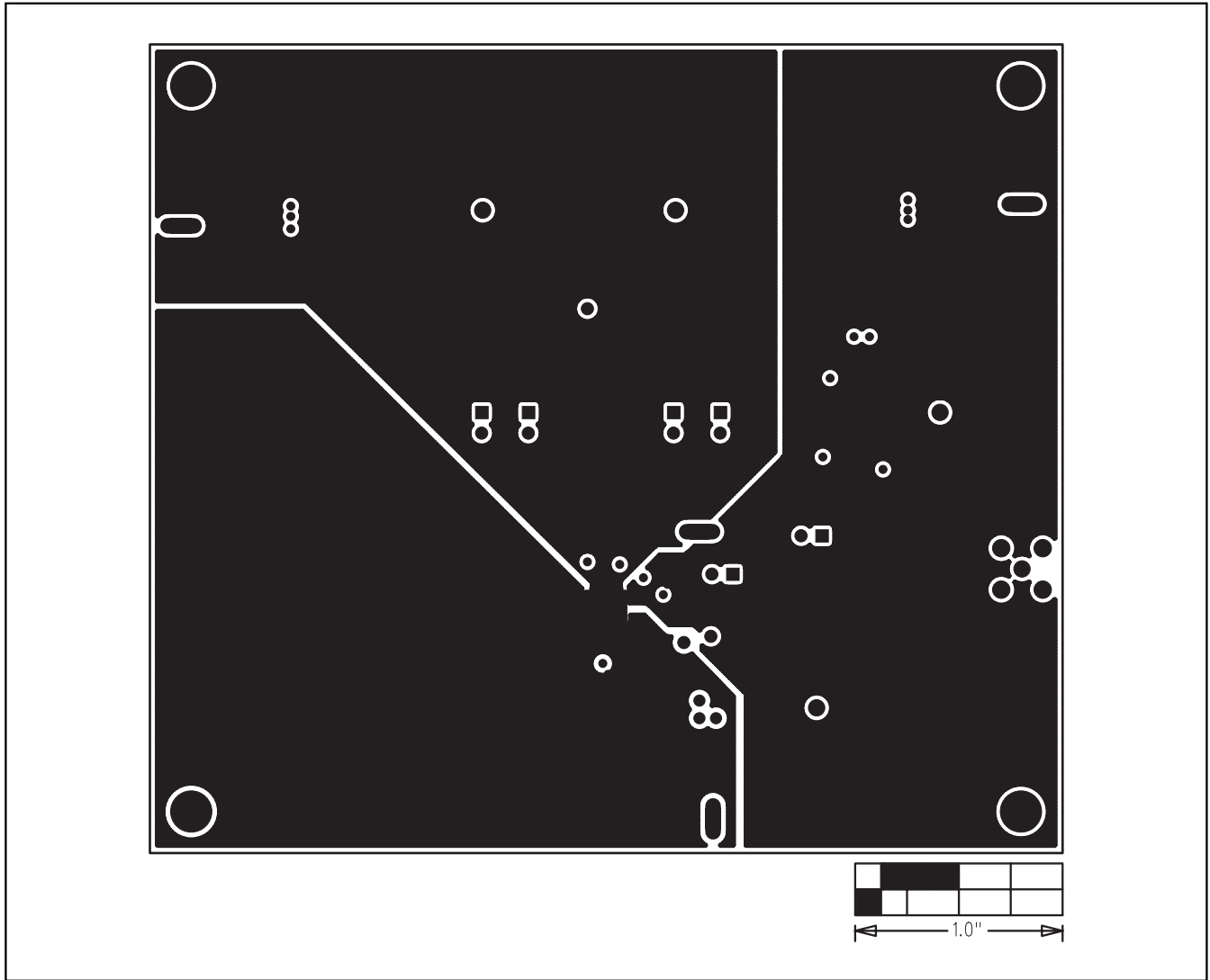

Figure 5. MAX5854 EV Kit PC Board Layout—Ground Planes (Layer 2)

# MAX5854 Evaluation Kit

Evaluates: MAX5854/MAX5853

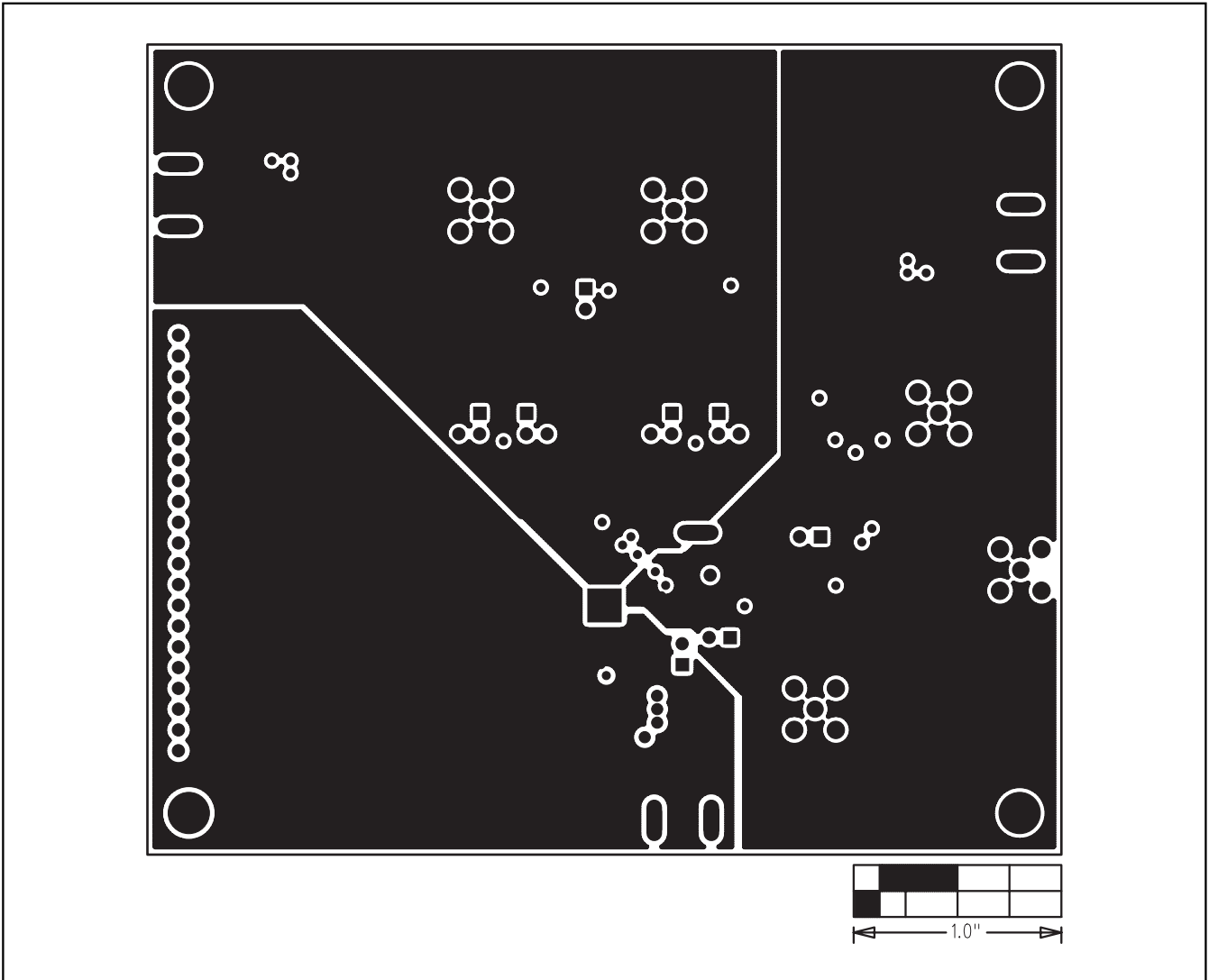

Figure 6. MAX5854 EV Kit PC Board Layout—Power Planes (Layer 3)

# MAX5854 Evaluation Kit

Evaluates: MAX5854/MAX5853

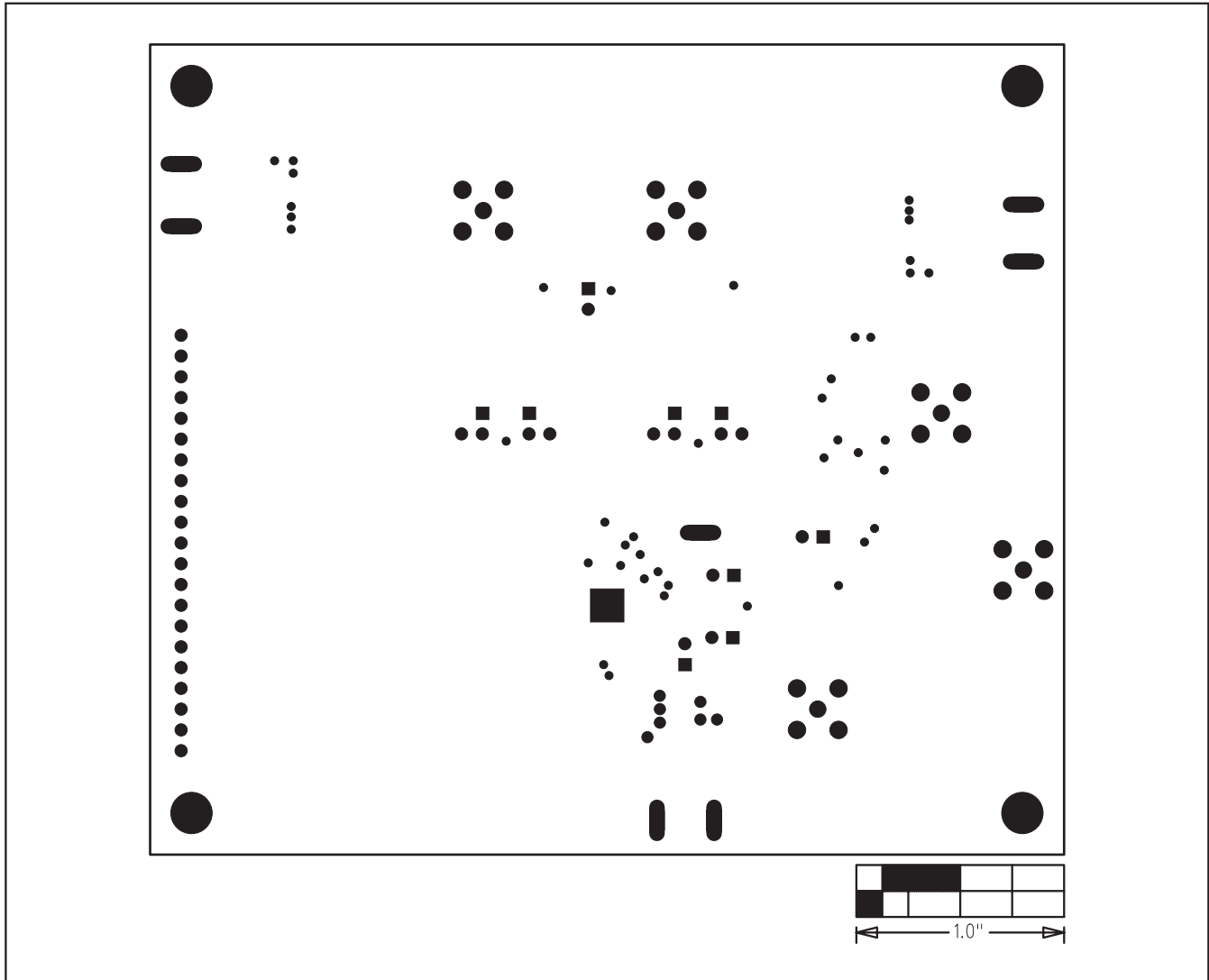

Figure 7. MAX5854 EV Kit PC Board Layout—Solder Side (Layer 4)

Maxim cannot assume responsibility for use of any circuitry other than circuitry entirely embodied in a Maxim product. No circuit patent licenses are implied. Maxim reserves the right to change the circuitry and specifications without notice at any time.

10 \_\_\_\_\_ Maxim Integrated Products, 120 San Gabriel Drive, Sunnyvale, CA 94086 408-737-7600