



MAX5065 Evaluation Kit

General Description

The MAX5065 evaluation kit (EV kit) provides a +1.3V adjustable output voltage from a +12V input source. It delivers up to 10A of output current with a switching frequency of 250kHz per phase and achieves efficiencies up to 85%.

The MAX5065 dual-phase, PWM controller provides high-output-current capability in a compact package with a minimum number of external components. The MAX5065 utilizes a dual-phase, average current-mode control that enables optimal use of low $R_{DS(ON)}$ MOSFETs, eliminating the need for external heatsinks even when delivering high output currents.

Differential sensing enables accurate control of the output voltage, while adaptive voltage positioning provides optimum transient response. An internal regulator enables operation with input voltage ranges of +4.5V to +5.5V or +8V to +28V. The high switching frequency and dual-phase operation allow the use of low-output inductor values and input capacitor values. This accommodates the use of PC-board-embedded planar magnetics achieving superior reliability, current sharing, thermal management, compact size, and low system cost.

The MAX5065 also features a clock input (CLKIN) for synchronization to an external clock, and a clock output (CLKOUT) with programmable phase delay (relative to CLKIN/DH) for paralleling multiple phases. The MAX5065 also limits the reverse current if the bus voltage becomes higher than the regulated output voltage. This device is specifically designed to limit current sinking when multiple power-supply modules are paralleled. The MAX5065 offers an adjustable +0.6V to +3.3V output voltage.

Ordering Information

PART	TEMP RANGE	IC PACKAGE
MAX5065EVKIT	0°C to +70°C*	28 SSOP

*+70°C operation requires 200LFM airflow.

Features

- ◆ 10A Output Current
- ◆ 250kHz Switching Frequency/Phase
- ◆ Up to 85% Efficiency
- ◆ +10V to +14V Input Voltage
- ◆ V_{OUT} Set to +1.3V
(Adjustable from +0.6V to +3.3V)

Component List

DESIGNATION	QTY	DESCRIPTION
C1	1	1 μ F \pm 10%, 16V X7R ceramic capacitor (0805) Kemet C0805C105K4RAC Murata GRM21BR71C105K
C2, C3, C13	3	0.1 μ F \pm 10%, 10V X5R ceramic capacitors (0402) Kemet C0402C104K8PAC Murata GRP155R61A104K
C4	1	470pF \pm 10%, 50V X7R ceramic capacitor (0402) Kemet C0402C471K5RAC Murata GRP155R71H471K
C5, C6	2	100pF \pm 5%, 50V C0G ceramic capacitors (0402) Kemet C0402C101J5GAC Murata GRP1555C1H101J
C7	1	4700pF \pm 10%, 50V X7R ceramic capacitor (0402) Kemet C0402C472K5RAC Murata GRP155R71H472K
C8, C9	2	0.01 μ F \pm 10%, 25V X7R ceramic capacitors (0402) Kemet C0402C103K3RAC Murata GRP155R71E103K
C10	1	4.7 μ F \pm 20%, 6.3V X5R ceramic capacitor (0603) Murata GRM188R60J475K
C11	1	330 μ F \pm 20%, 2.5V, 9m Ω POSCAP Sanyo 2R5TPE330M9
C12	1	1000pF \pm 10%, 50V X7R ceramic capacitor (0402) Kemet C0402C102K5RAC Murata GRP155R71H102K

Evaluates: MAX5065

MAX5065 Evaluation Kit

Component List (continued)

DESIGNATION	QTY	DESCRIPTION
C14	1	0.1 μ F \pm 10%, 25V X7R ceramic capacitor (0603) Kemet C0603C104K3RAC Murata GRM188R71E104K
C15	1	10 μ F \pm 20%, 16V X5R ceramic capacitor (1206) Kemet C1206C106M4PAC Murata GRM31CR61C106M
D1	1	0.2A, 30V SOT-323 dual Schottky diode, common anode Central Semiconductor CMS5H-3A Diodes Inc. BAT54AW
D2, D3	1	1A, 30V, SOD-123 Schottky diodes Diodes Inc. 1N5819HW Toshiba CRS01
J1	1	5-pin header, single row, right angle
J2	1	6-pin header, 0.1in center
L1, L2	2	1 μ H, 8A inductors TOKO FDV0630-1R0M
N1, N2	2	30V, 20A, 4m Ω , 8-pin SO, n-channel MOSFETs International Rectifier IRF7832

DESIGNATION	QTY	DESCRIPTION
N3, N4	2	30V, 13.6A, 9.1m Ω , 8-pin SO, n-channel MOSFETs International Rectifier IRF7821
R1, R2	2	0.007 Ω \pm 1%, 0.5W current-sense resistors (2010) IRC LRC-LRF2010-01-R007-F Vishay Dale WSL2010 0.007 1.0%
R3	1	97.6k Ω \pm 1% resistor (0402)
R4	1	5.62k Ω \pm 1% resistor (0402)
R5	1	4.99k Ω \pm 1% resistor (0402)
R6	1	7.5k Ω \pm 5% resistor (0402)
R7, R8	2	1.8k Ω \pm 5% resistors (0402)
R9	1	25.5k Ω \pm 1% resistor (0402)
R10	1	4.02k Ω \pm 1% resistor (0402)
R11, R12	0	Not installed, resistors (0603)
R13	1	10 Ω \pm 5% resistor (0402)
R14	1	10k Ω \pm 5% resistor (0603)
U1	1	MAX5065EAI, 28-pin SSOP

Component Suppliers

SUPPLIER	PHONE	FAX	WEBSITE
Central Semiconductor	631-435-1110	631-435-1824	www.centralsemi.com
Diodes Inc.	805-446-4800	805-446-4850	www.diodes.com
International Resistive Co. (IRC)	361-992-7900	361-992-3377	www.irctt.com
Kemet	864-963-6300	864-963-6322	www.kemet.com
Murata	770-436-1300	770-436-3030	www.murata.com
Sanyo	619-661-6835	619-661-1055	www.sanyovideo.com
TOKO	847-297-0070	847-699-1194	www.tokoam.com
Toshiba	949-455-2000	949-859-3963	www.toshiba.com/taec
Vishay Dale	402-564-3131	402-563-6296	www.vishay.com

Note: Indicate you are using the MAX5065 when contacting these manufacturers.

MAX5065 Evaluation Kit

Quick Start

Recommended Equipment

- DC power source capable of supplying 2A at +12V
- Voltmeter
- Load

Procedure

The MAX5065 EV kit is a fully assembled and tested surface-mount board. Follow the steps below to verify board operation. **Do not turn on the power supply until all connections are completed:**

- 1) Connect the DC power source to the V_{IN} and GND pins of the MAX5065 EV kit. The pin diagram is shown in Figure 1.
- 2) Connect the load to the V_{OUT} and GND pins.
- 3) Connect the voltmeter across V_{OUT} and GND.
- 4) Turn on the power supply.
- 5) Verify the voltage at V_{OUT} is +1.3V.

Detailed Description

The MAX5065 EV kit provides a +1.3V adjustable output voltage from a +12V input source. It delivers up to 10A of output current.

Remote Voltage Sensing

For high currents, there can be significant voltage drop across the wires connecting the MAX5065 EV kit to the load. To compensate for this voltage drop, the MAX5065 EV kit includes a remote sense pin that allows the voltage to be sensed at the load.

To use this feature, connect a wire from remote sense (pin 3 of J1 on the MAX5065 EV kit) to the positive side of the load.

Enable

EN (pin 15 on the MAX5065) is internally pulled up to V_{CC} with 5μA of current. This allows the MAX5065 to power on

when the +12V input source powers on. To control enable with an external signal generator, connect the external signal generator to ENABLE (pin 6 of J2 on the MAX5065 EV kit). A logic low shuts down the power drivers.

Output Voltage

The MAX5065 EV kit provides a +1.3V output voltage. Change the output voltage to a value between +0.6V and +2.5V by changing the resistor-divider R4/R5.

Note: The output voltage is programmable up to +3.3V; however the output capacitor must be replaced with a higher voltage-rating capacitor.

Use the following equation to set the no-load output voltage:

$$R4 = R5 \left[\left(\frac{V_{OUT(NOLOAD)}}{0.6V} \times \frac{R3}{R3+R10} \right) - 1 \right]$$

where R3 = 97.6kΩ and R10 = 4.02kΩ.

Use ±1% resistors between 1kΩ and 10kΩ for R5.

Table 1. MAX5065 EV Kit Pinout

CONNECTOR	PIN	NAME	DESCRIPTION
J1	1	V _{OUT}	Voltage output
	2	V _{OUT}	Voltage output
	3	Remote Sense	High-side, remote voltage-sense input
	4	V _{OUT}	Voltage output
	5	PGND	Power ground
J2	1	PGND	Power ground
	2	V _{IN}	Voltage input
	3	V _{IN}	Voltage input
	4	N.C.	No connection
	5	N.C.	No connection
	6	EN	Enable

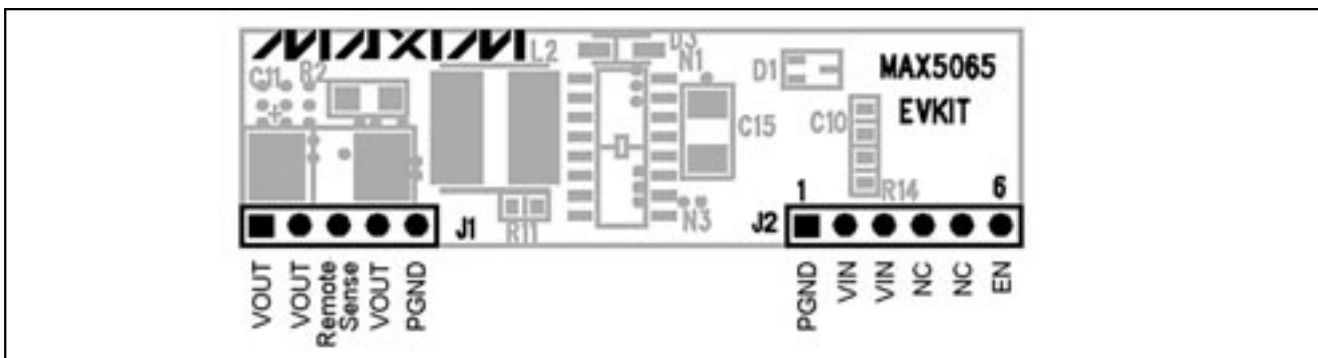

Figure 1. MAX5065 EV Kit Pinout

MAX5065 Evaluation Kit

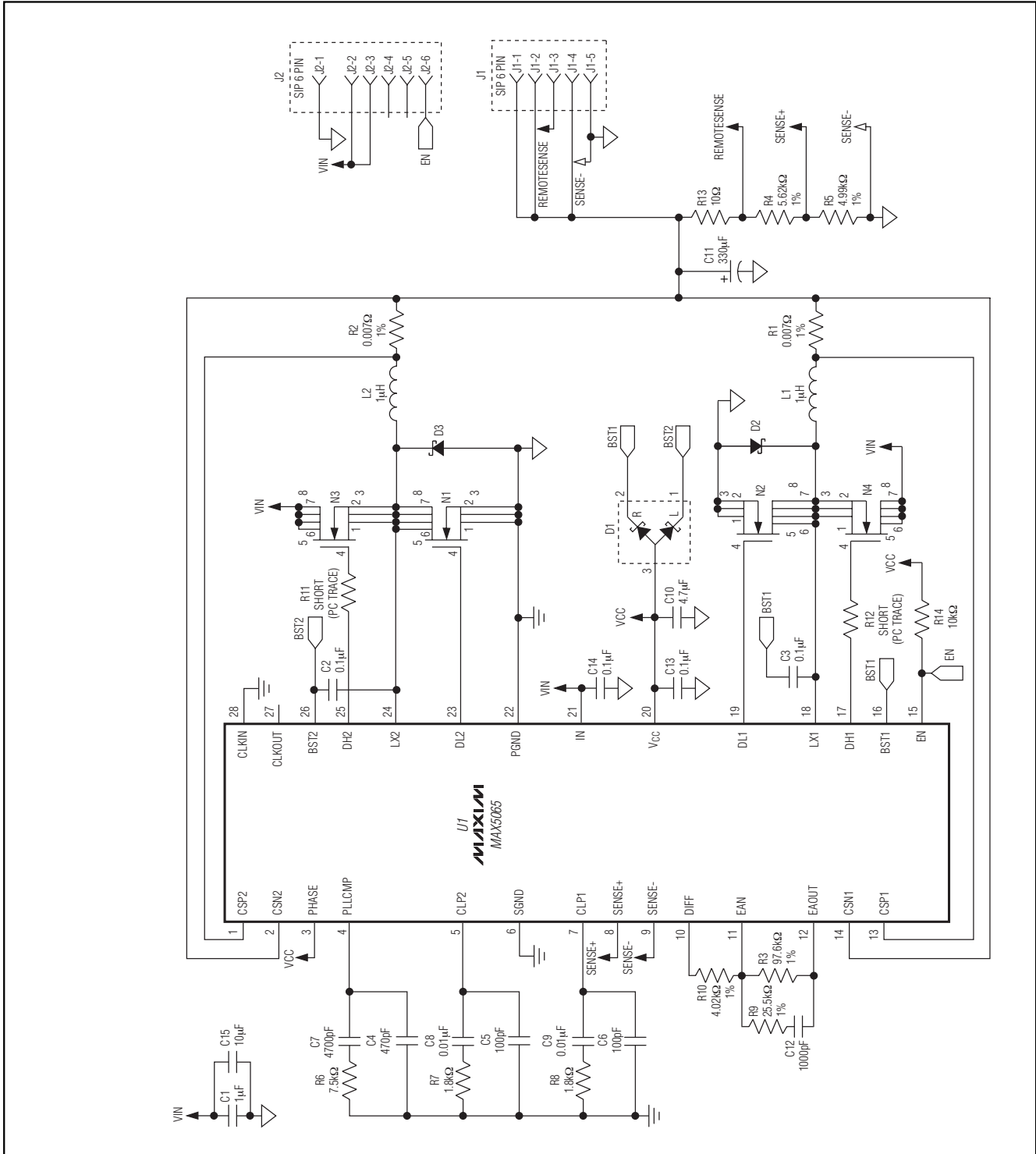

Figure 2. MAX5065 EV Kit Schematic

MAX5065 Evaluation Kit

Evaluates: MAX5065

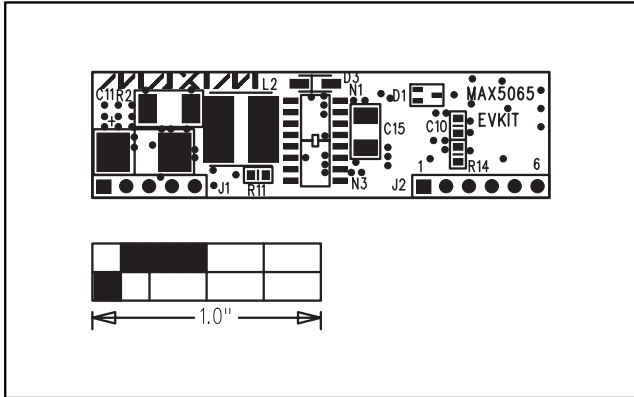

Figure 3. MAX5065 EV Kit Component Placement Guide—Top Layer

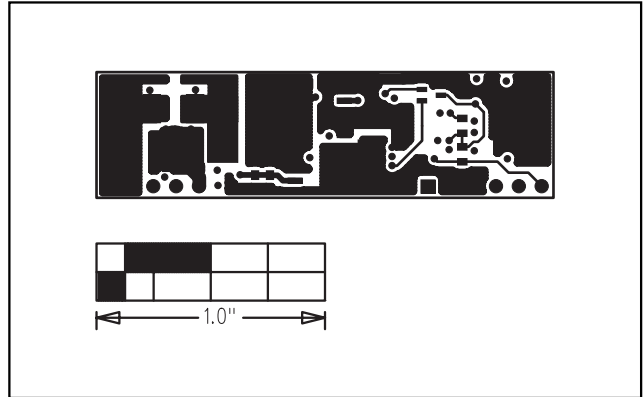

Figure 4. MAX5065 EV Kit PC Board Layout—Top Layer

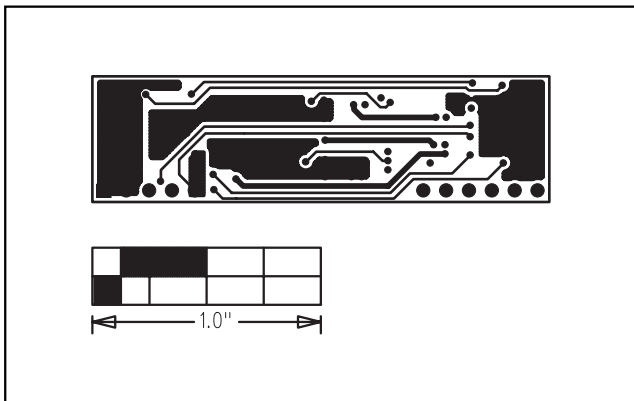

Figure 5. MAX5065 EV Kit PC Board Layout—Signal (Layer 2)

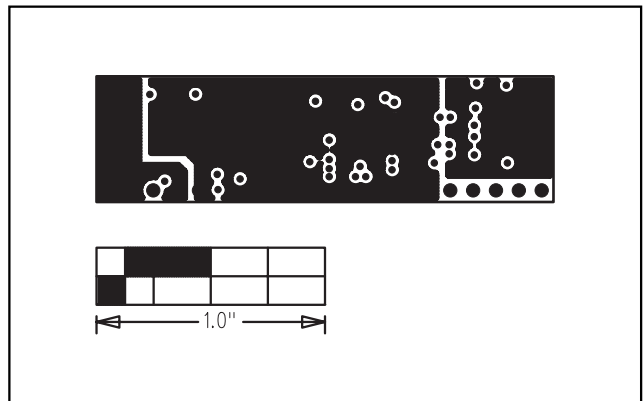

Figure 6. MAX5065 EV Kit PC Board Layout—GND, PGND, and VOUT (Layer 3)

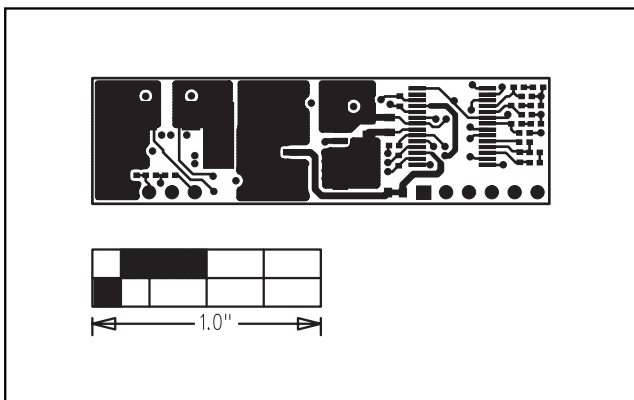

Figure 7. MAX5065 EV Kit PC Board Layout—Bottom Layer

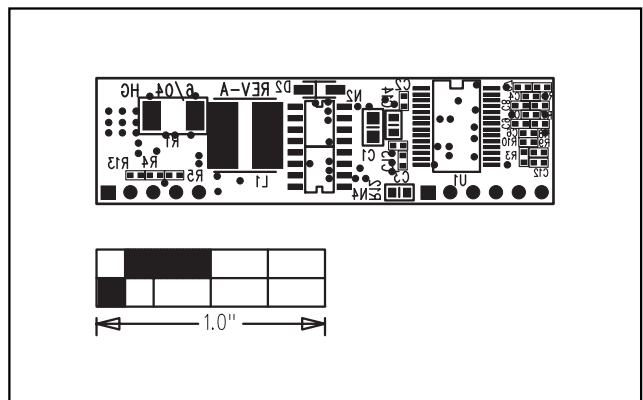

Figure 8. MAX5065 EV Kit Component Placement Guide—Bottom Layer

Maxim cannot assume responsibility for use of any circuitry other than circuitry entirely embodied in a Maxim product. No circuit patent licenses are implied. Maxim reserves the right to change the circuitry and specifications without notice at any time.

Maxim Integrated Products, 120 San Gabriel Drive, Sunnyvale, CA 94086 408-737-7600 _____ 5