



MAX2831 Evaluation Kit

General Description

The MAX2831 evaluation kit (EV kit) simplifies testing of the MAX2831 receive and transmit performance in 802.11g/b applications operating in the 2.4GHz to 2.5GHz ISM band. The EV kit provides 50Ω SMA connectors for all RF and baseband inputs and outputs. Differential-to-single-ended and single-ended-to-differential line drivers are provided to convert the differential I/Q baseband inputs and outputs to single ended.

Features

- ◆ On-Board Line Driver and Voltage Reference
- ◆ 50Ω SMA Connectors on All RF and Baseband Ports
- ◆ PC Control Software Available at www.maxim-ic.com

Ordering Information

PART	TEMP RANGE	IC PACKAGE
MAX2831EVKIT+	-40°C to +85°C	48 Thin QFN-EP*

+ Denotes a lead-free and RoHS-compliant EV kit.

*EP = Exposed paddle.

Component List

DESIGNATION	QTY	DESCRIPTION
C1	1	33pF ±5% capacitor (0402) Murata GRM1555C1H330J
C3, C16, C70, C79, C81, C89	6	100pF ±5% capacitors (0402) Murata GRM1555C1H101J
C4	1	18pF ±5% capacitor (0402) Murata GRM1555C1H180J
C5, C7, C10, C11, C13, C17, C18, C21, C22, C29, C40, C42, C43, C45, C46, C50, C52, C54, C59, C60, C64, C67, C83, C86	24	100nF ±10% capacitors (0402) Murata GRM155R61A104K
C6, C9, C30, C41, C62, C73, C74, C75, C87, C88	10	0.01μF ±10% capacitors (0402) Murata GRM155R71C103K
C8, C44, C48, C49, C71, C72, C77	0	Not installed
C12, C51, C53, C55, C63, C65, C66	7	10μF ±20% tantalum capacitors (R-case) AVX TAJR106M006
C61	1	10μF ±10% capacitor (1206) Murata GRM31CR60J106K
C68, C69	2	1.5pF ±0.25pF capacitors (0402) Murata GRM1555C1H1R5C
C76	1	1000pF ±10% capacitor (0402) Murata GRM155R71H102K

DESIGNATION	QTY	DESCRIPTION
C78	1	2200pF ±10% capacitor (0402) Murata GRM155R71H222K
C80	1	68pF ±5% capacitor (0402) Murata GRM1555C1H680J
C82	1	10μF ±10% capacitor (0805) Murata GRM21BR60J106K
J17	0	Not installed
J18	1	DB25 right-angle male connector AMP 5747238-4
JPB1–JPB4, JPB6, JPB7, JPCSB, JPDIN, JPLD, JPRXHP, JPCLK, JP SHDNB	0	Not installed
L1, L2, L7	0	Not installed
LDO_IN, VREG	2	1 x 2 headers Sullins PEC36SAAN
R1, R2, R6, R10, R16, R17, R22, R27	8	75Ω ±1% resistors (0402)
R3, R7, R18, R23	4	3.3kΩ ±5% resistors (0402)
R4, R5, R21, R26	4	49.9Ω ±1% resistors (0402)
R8, R9, R12, R13, R28, R29, R31, R32	8	0Ω ±1% resistors (0402)
R11, R30, R38, R46, R50	0	Not installed
R14	1	270Ω ±5% resistor (0402)
R39, R45	2	100Ω ±1% resistors (0402)

Evaluates: MAX2831

MAX2831 Evaluation Kit

Component List (continued)

DESIGNATION	QTY	DESCRIPTION
R43	1	1k Ω \pm 1% resistor (0402)
R51	1	1.2k Ω \pm 5% resistor (0402)
R52	1	750 Ω \pm 5% resistor (0402)
R53	1	10k Ω \pm 5% resistor (0402)
T1	0	Not installed
T2, T3	2	2.4GHz RF baluns Murata LDB212G4010C-001
U1, U5	2	Maxim MAX4447ESE+
U2, U6	2	Maxim MAX4444ESE+
U3	1	Low-dropout reference Maxim MAX6061BEUR+
U4	1	Maxim MAX2831ETM+
U8, U9	2	SN74LVTH244ADB Texas Instruments SN74LVTH244ADBR
U10	0	MAX8882EUTJJ+ (not installed/optional)
Y1	1	40MHz crystal Kyocera CX3225SB40000H0WZK21
+5V, -5V, B1-B7, CSB, DIN, GND1, GND2, LD, RSSI, RXBBI+, RXBBI-, RXBBQ+, RXBBQ-, RXHP, SCLK, SHDNB, TPANTSEL, TPCLKOUT, TPRXTX, TPTUNE, TPTXCMIN, TXBBI+ TXBBI-, TXBBQ+, TXBBQ-, VBAT, VCCAUX	33	Test points Keystone 5000

DESIGNATION	QTY	DESCRIPTION
CLKOUT, FREF, RXBBI, RXBBQ, RXRF, TXBBI, TXBBQ, TXRF	8	SMA edge-mount connectors, round Johnson 142-0701-801
VCCLNA, VCCPA1, VCCPA2, VCCPLL, VCCRBB1, VCCRBB2, VCCRXXM, VCCXXM, VCCXTAL, VCC_DB, VCC_REF, VREG	0	Not installed
—	6	Shunts (ANTSEL, LDO_IN, RXBBBUF, RXTX, TXBBBUF, VCCVCO) Sullins SSC02SYAN

Component Suppliers

SUPPLIER	PHONE	FAX	WEBSITE
AVX Corp.	843-448-9411	843-448-1943	www.avx.com
Digi-Key Corp.	800-344-4539	218-681-3380	www.digikey.com
Johnson Components	800-247-8256	507-833-6287	www.johnsoncomponents.com
Murata Mfg. Co., Ltd.	770-436-1300	770-436-3030	www.murata.com
Texas Instruments Inc.	—	—	www.ti.com

Note: Indicate that you are using the MAX2831 when contacting these component suppliers.

MAX2831 Evaluation Kit

Quick Start

The MAX2831 EV kit is fully assembled and factory tested. Follow the instructions in the *Connections and Setup* section to test the devices.

Test Equipment Required

This section lists the recommended test equipment to verify the operation of the MAX2831. It is intended as a guide only and substitutions may be possible:

- DC supply capable of delivering +5V and 200mA of continuous current
- DC supply capable of delivering -5V and 200mA of continuous current
- DC supply capable of delivering +3.3V and 300mA of continuous current
- DC supply capable of delivering +2.85V and 200mA of continuous current
- Two HP8648s or equivalent signal sources capable of generating 0dBm up to 3GHz
- 802.11b/g OFDM I/Q waveform generator
- HP8561E or equivalent RF spectrum analyzer with a minimum 100kHz to 3GHz frequency range
- TDS3012 or equivalent oscilloscope with 200MHz bandwidth
- HP437B power meter and power head
- IBM PC or PC-compatible computer with Windows® 95/98/2000/XP (or later) operating system with an available parallel port
- Female-to-male 25-pin parallel straight-through cable
- RF coupler

Connections and Setup

This section provides step-by-step instructions for getting the EV kit up and running in all modes:

- 1) Install and run the MAX2831 control software, available for download at www.maxim-ic.com/evkitsoftware.
- 2) To control the EV kit through the 3-wire interface, connect the male-to-female 25-pin parallel cable between the PC and the EV kit.
- 3) With the power supply turned off, connect a +2.85V power supply to VREG (pin 1, ■), VCCVCO (pins 2-3, ●●), and VCCAUX, and a +3.3V power supply to VBAT. Connect the power-supply ground to the header labeled GND1 or GND2.

- 4) With the power supply turned off, connect a +5V power supply to the +5V pin and a -5V power supply to the -5V pin. Connect the power-supply ground to the header labeled GND1 or GND2. Connect all the power-supply grounds together.
- 5) Turn on the +3.3V power supply, followed by the +2.85V power supply, +5V power supply, and -5V power supply.

Receive Mode

- 1) Set the RXTX jumper across pins 2-3 (RX) to enable the receiver and disable the transmitter.
- 2) Use the power meter to calibrate the RF signal generator to deliver -100dBm at 2438MHz. After calibration, turn the RF signal generator off, disconnect it from the power meter, and connect it to the receive port of the MAX2831 EV kit.
- 3) On the register-setting page of the EV kit software, set the register setting to the recommended setting in the MAX2831 data sheet by clicking the “send all” button. On the entry page, confirm that the receive mode is set to “normal,” baseband filter is set to “RX,” and the RF frequency is tuned to 2437MHz. Maximize the LNA gain and adjust the baseband gain using the RX VGA gain setting to achieve 98dB of gain.
- 4) Connect the spectrum analyzer to either RXBBI or RXBBQ. Set the center frequency to 1MHz with a span of 500kHz.
- 5) Turn on the RF signal source. The output CW tone at 1MHz should be approximately -2dBm.

Transmit Mode

- 1) Set the RXTX jumper across pins 1-2 (TX) to enable the transmitter and disable the receiver.
- 2) Connect a decoupler and a 10dB attenuator to the TXRF. Connect the spectrum analyzer and the power meter to the outputs of the decoupler.
- 3) Connect a 1MHz I/Q signal to TXBBI and TXBBQ. Set the input amplitude of each channel to 100mVRMS.
- 4) On the register-setting page of the EV kit software, set the register setting to the recommended register setting listed in the MAX2831 data sheet. Make sure that the transmitter mode is set to “normal,” baseband filter is set to “TX,” and the RF frequency is tuned to 2437MHz.
- 5) Enable the output of the baseband signal sources. The sideband, LO leakage, and the carrier appear at 2436MHz, 2437MHz, and 2438MHz, respectively. Adjust the TX gain sliding bar to observe the power level in the power meter reading.

Windows is a registered trademark of Microsoft Corp.

MAX2831 Evaluation Kit

Table 1. Jumper Functions

JUMPER	SETTING	FUNCTION
RXTX	Pins 2-3	Enable receive mode
	Pins 1-2	Enable transmit mode
ANTSEL	Pins 2-3	Default
TXBBBUF/RXBBBUF	Pins 1-2	Enables the buffers
	Pins 2-3	Disables the buffers
VREG	Pins 1-2	Short the jumper to provide voltage to the MAX2831 from the linear regulator (U10)
VCCVCO	Pins 2-3	Supply the VCCVCO from VREG
	Pins 1-2	Supply the VCCVCO from the linear regulator (U10)

Note: A square symbol (■) on top-layer silkscreen indicates pin 1.

Layout Considerations

The MAX2831 EV kit can serve as a guide for board layout. Keep PCB trace lengths as short as possible to minimize parasitic inductance. Also, keep decoupling capacitors as close to the IC as possible with a direct connection to the ground plane.

Power-Supply Layout

To minimize coupling between different sections of the IC, use a star power-supply routing configuration with a large decoupling capacitor at a central VCC node. The VCC traces branch out from this node, each going to a separate VCC node in the circuit. Place a bypass capacitor as close to each supply pin as possible. This arrangement provides local decoupling at each VCC pin. Use at least one via per bypass capacitor for a low-inductance ground connection. Do not share the capacitor ground vias with any other branch.

MAX2831 Evaluation Kit

Evaluates: MAX2831

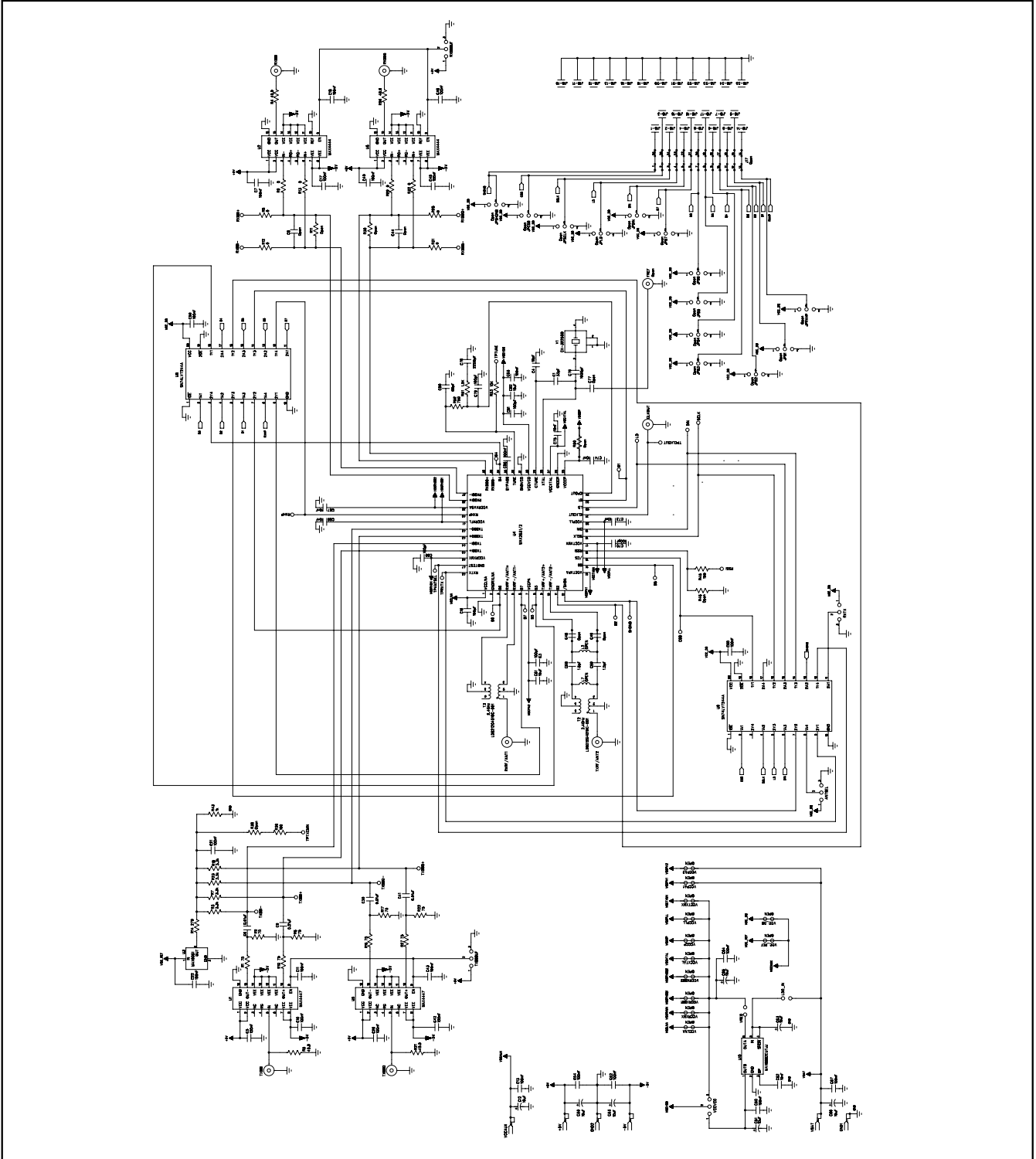

Figure 1. MAX2831 EV Kit Schematic

MAX2831 Evaluation Kit

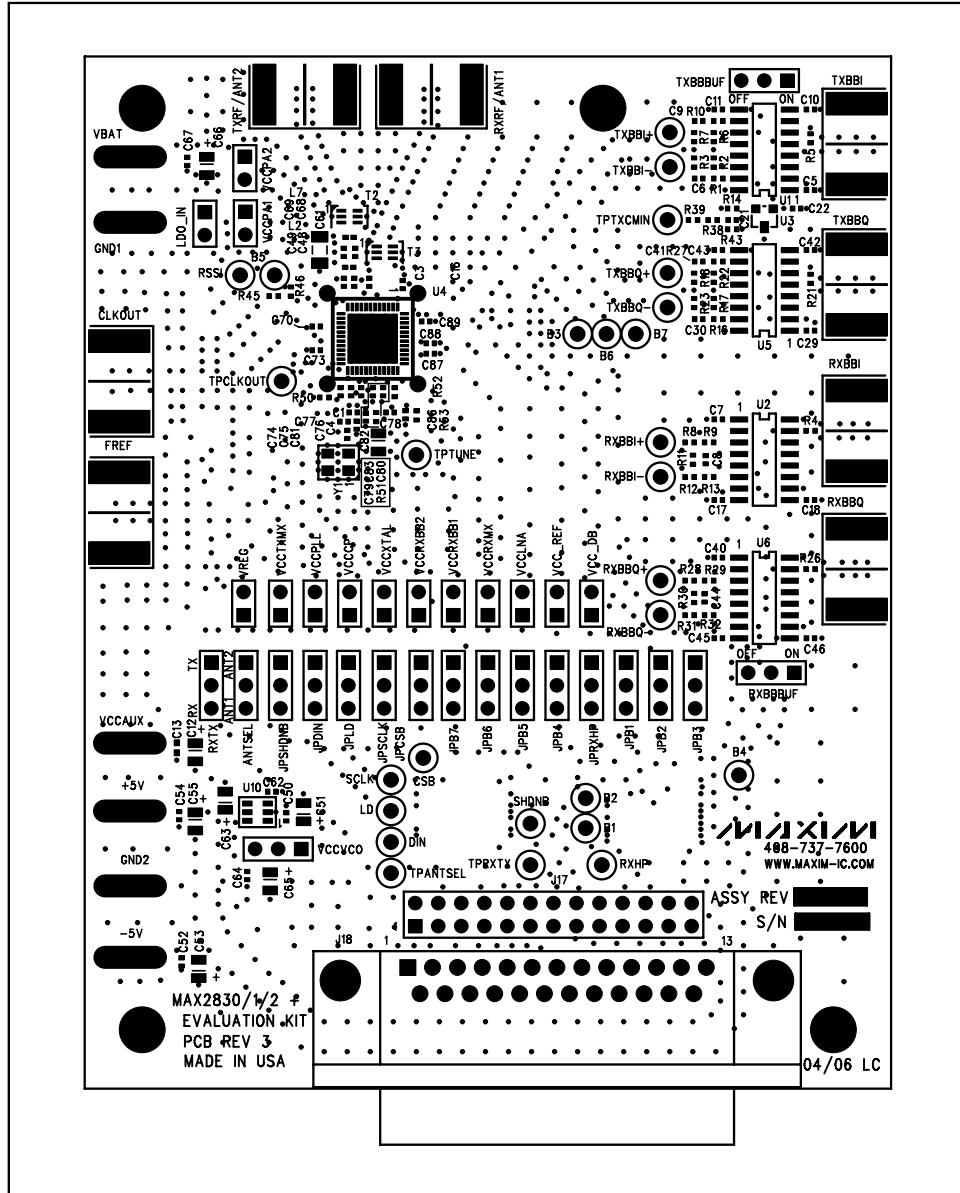

Figure 2. MAX2831 EV Kit PCB Layout—Top Silkscreen

MAX2831 Evaluation Kit

Evaluates: MAX2831

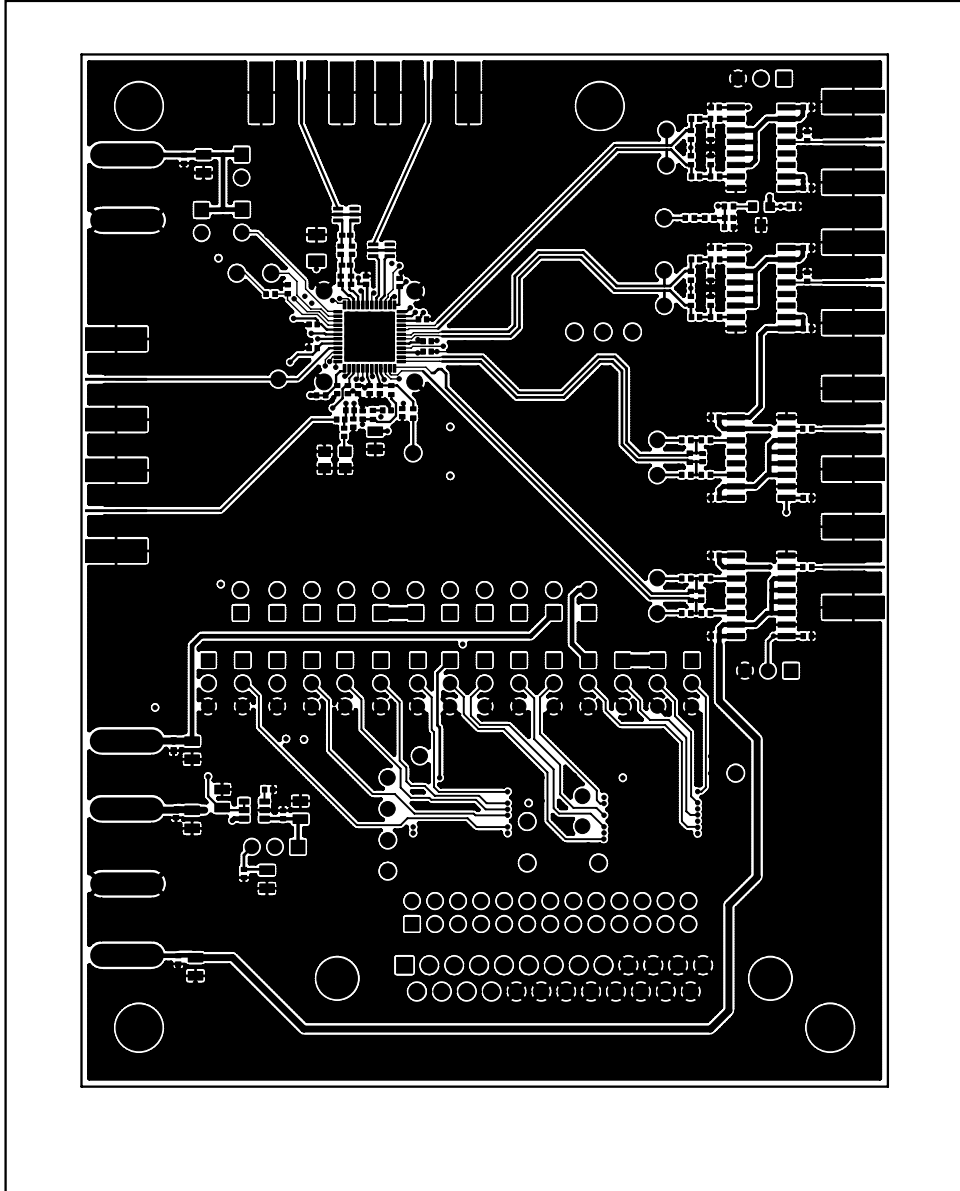

Figure 3. MAX2831 EV Kit PCB Layout—Component Side

MAX2831 Evaluation Kit

Evaluates: MAX2831

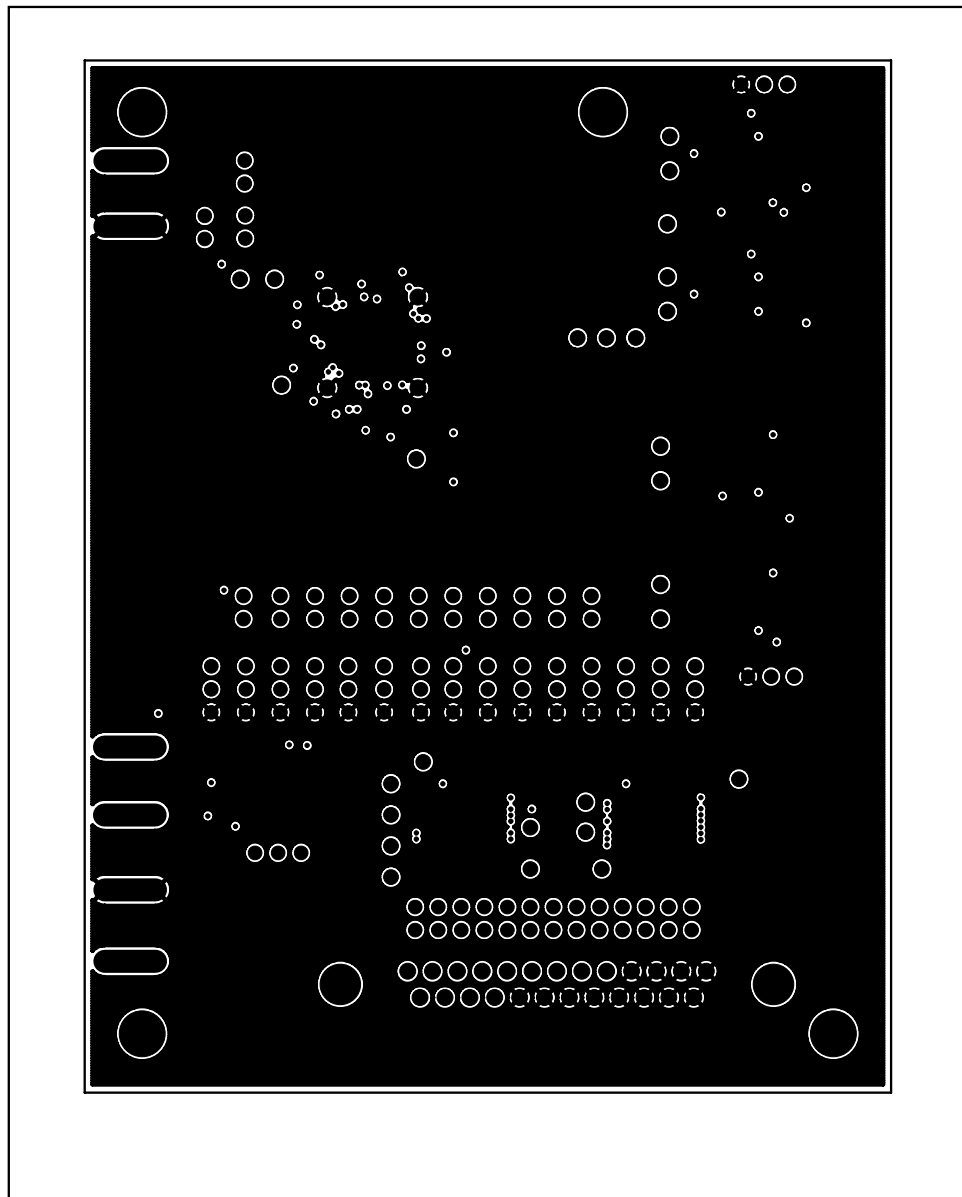

Figure 4. MAX2831 EV Kit PCB Layout—Inner Layer 2 (Ground Layer)

MAX2831 Evaluation Kit

Evaluates: MAX2831

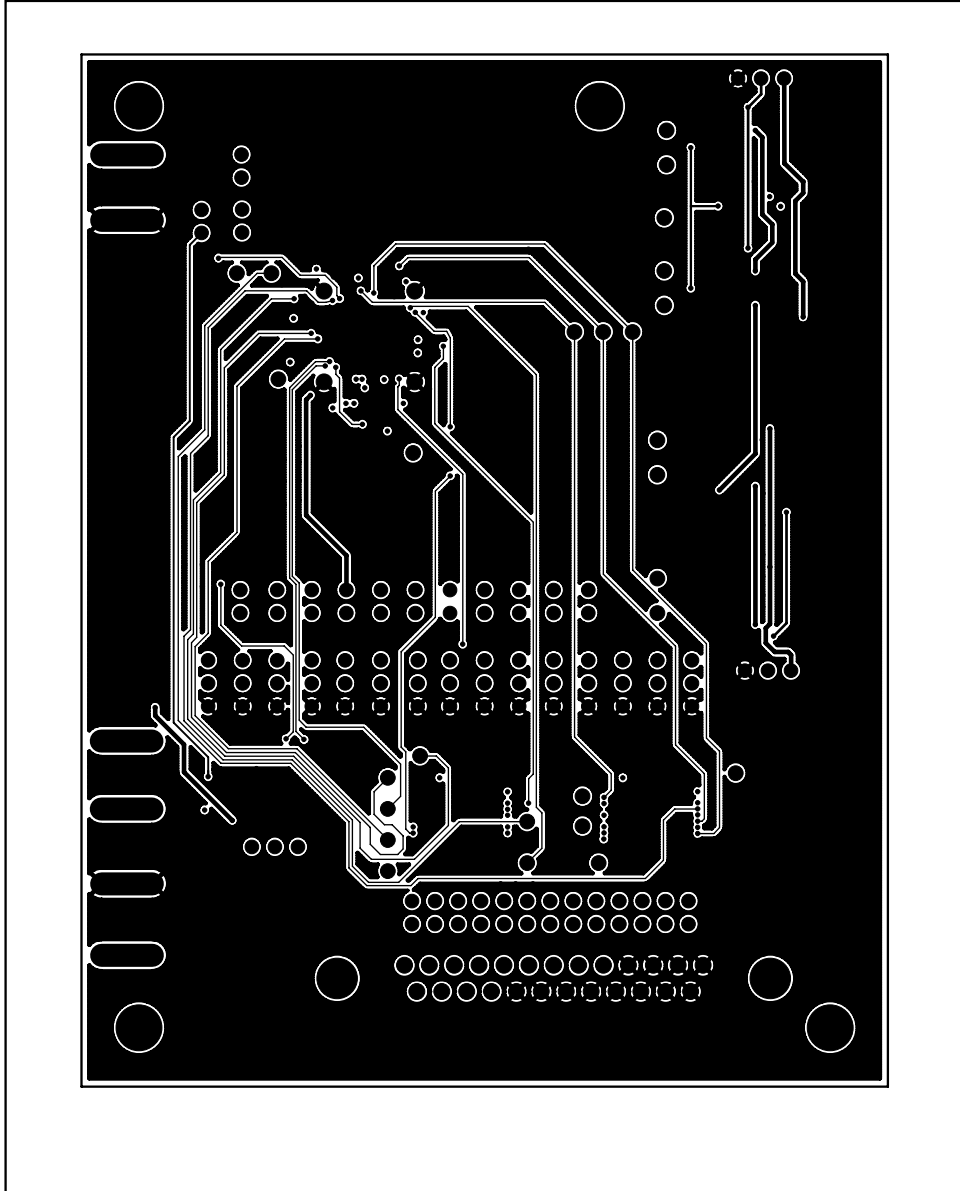

Figure 5. MAX2831 EV Kit PCB Layout—Inner Layer 3 (Routes)

MAX2831 Evaluation Kit

Evaluates: MAX2831

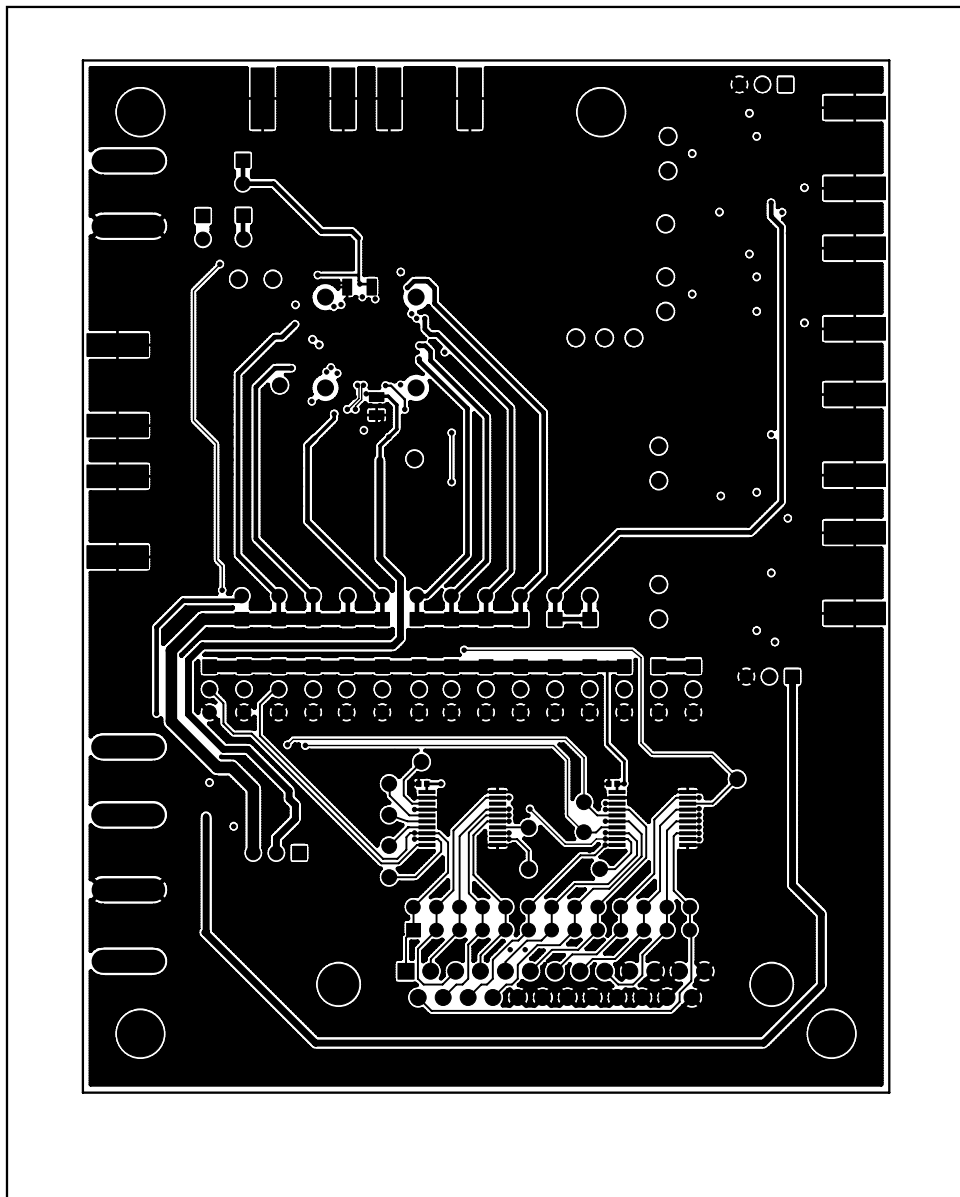

Figure 6. MAX2831 EV Kit PCB Layout—Solder Side

MAX2831 Evaluation Kit

Evaluates: MAX2831

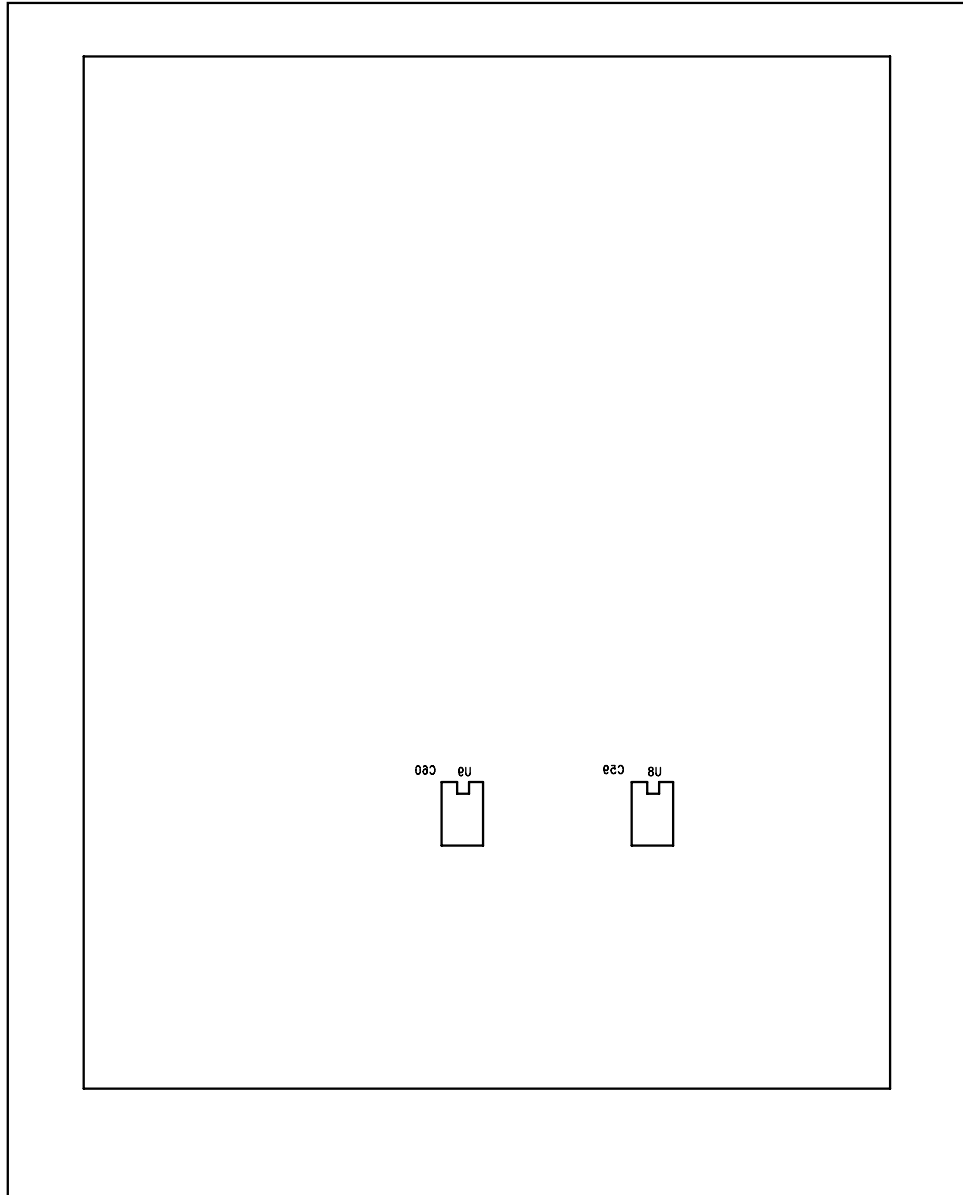

Figure 7. MAX2831 EV Kit PCB Layout—Bottom Silkscreen

Maxim cannot assume responsibility for use of any circuitry other than circuitry entirely embodied in a Maxim product. No circuit patent licenses are implied. Maxim reserves the right to change the circuitry and specifications without notice at any time.

Maxim Integrated Products, 120 San Gabriel Drive, Sunnyvale, CA 94086 408-737-7600 _____ 11