



# SiGe, High-Linearity, 850MHz to 1550MHz Up/Downconversion Mixer with LO Buffer

MAX2051

## General Description

The MAX2051 high-linearity, up/downconversion mixer provides +35dBm input IP3, 7.8dB noise figure (NF), and 7.4dB conversion loss for 850MHz to 1550MHz wireless infrastructure and multicarrier cable head-end downstream video, video-on-demand (VOD), and cable modem termination systems (CMTS) applications. The MAX2051 also provides excellent suppression of spurious intermodulation products (> 77dBc at an RF level of -14dBm), making it an ideal downconverter for DOCSIS® 3.0 and Euro DOCSIS cable head-end systems. With an LO circuit tuned to support frequencies ranging from 1200MHz to 2250MHz, the MAX2051 is ideal for high-side LO injection applications over an IF frequency range of 50MHz to 1000MHz.

In addition to offering excellent linearity and noise performance, the MAX2051 also yields a high level of component integration. The device integrates baluns in the RF and LO ports, which allow for a single-ended RF input and a single-ended LO input. The MAX2051 requires a typical LO drive of 0dBm and a supply current guaranteed to below 130mA.

The MAX2051 is available in a compact 5mm x 5mm, 20-pin thin QFN package with an exposed pad. Electrical performance is guaranteed over the extended temperature range, from  $T_C = -40^{\circ}\text{C}$  to  $+85^{\circ}\text{C}$ .

## Applications

Video-on-Demand and DOCSIS-Compatible Edge QAM Modulation  
Cable Modem Termination Systems  
Microwave and Fixed Broadband Wireless Access  
Microwave Links  
Military Systems  
Predistortion Receivers  
Private Mobile Radios  
Integrated Digital Enhanced Network (iDEN®) Base Stations  
WiMAX™ Base Stations and Customer Premise Equipment  
Wireless Local Loop

DOCSIS and CableLabs are registered trademarks of Cable Television Laboratories, Inc. (CableLabs®).  
iDEN is a registered trademark of Motorola, Inc.  
WiMAX is a trademark of WiMAX Forum.



## Features

- ◆ 850MHz to 1550MHz RF Frequency Range
- ◆ 1200MHz to 2250MHz LO Frequency Range
- ◆ 50MHz to 1000MHz IF Frequency Range
- ◆ DOCSIS 3.0 and Euro DOCSIS Compatible
- ◆ 7.4dB Typical Conversion Loss
- ◆ 7.8dB Typical Noise Figure
- ◆ +24dBm Typical Input 1dB Compression Point
- ◆ +35dBm Typical Input IP3
- ◆ 88dBc Typical 2RF-LO Rejection at  $P_{RF} = -14\text{dBm}$
- ◆ Integrated LO Buffer
- ◆ Integrated RF and LO Baluns for Single-Ended Inputs
- ◆ Low LO Drive (0dBm Nominal)
- ◆ External Current-Setting Resistor Provides Option for Operating Device in Reduced-Power/Reduced-Performance Mode

## Ordering Information

| PART         | TEMP RANGE     | PIN-PACKAGE     |
|--------------|----------------|-----------------|
| MAX2051ETP+  | -40°C to +85°C | 20 Thin QFN-EP* |
| MAX2051ETP+T | -40°C to +85°C | 20 Thin QFN-EP* |

+ Denotes a lead(Pb)-free/RoHS-compliant package.

\*EP = Exposed pad.

T = Tape and reel.

## Pin Configuration/ Functional Block Diagram

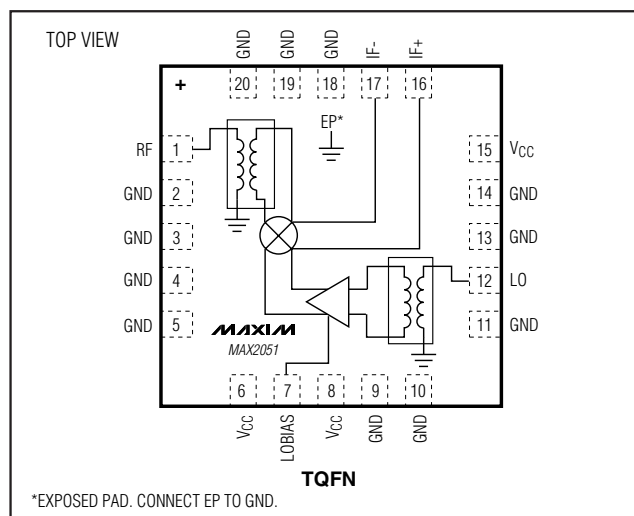

# SiGe, High-Linearity, 850MHz to 1550MHz Up/Downconversion Mixer with LO Buffer

## ABSOLUTE MAXIMUM RATINGS

|   |                                   |  |                                 |
|---|-----------------------------------|--|---------------------------------|
| V <sub>CC</sub> to GND  | -0.3V to +5.5V                    | θ <sub>JA</sub> (Notes 2, 3)                 | +33°C/W                         |
| RF, LO to GND   | -0.3V to 0.3V                     | θ <sub>JC</sub> (Note 3)                     | 8°C/W                           |
| IF+, IF-, LOBIAS to GND                                       | -0.3V to (V <sub>CC</sub> + 0.3V) | Operating Case Temperature Range<br>(Note 4) | T <sub>C</sub> = -40°C to +85°C |
| RF, LO Input Power  | +20dBm                            | Junction Temperature                         | +150°C                          |
| RF, LO Current (RF and LO is DC shorted to GND through balun) | 50mA                              | Storage Temperature Range                    | -65°C to +150°C                 |
| Continuous Power Dissipation (Note 1)                         | 2100mW                            | Lead Temperature (soldering, 10s)            | +300°C                          |

**Note 1:** Based on junction temperature  $T_J = T_C + (\theta_{JC} \times V_{CC} \times I_{CC})$ . This formula can be used when the temperature of the exposed pad is known while the device is soldered down to a PCB. See the *Applications Information* section for details. The junction temperature must not exceed +150°C.

**Note 2:** Junction temperature  $T_J = T_A + (\theta_{JA} \times V_{CC} \times I_{CC})$ . This formula can be used when the ambient temperature of the PCB is known. The junction temperature must not exceed +150°C.

**Note 3:** Package thermal resistances were obtained using the method described in JEDEC specification JESD51-7, using a four-layer board. For detailed information on package thermal considerations, refer to [www.maxim-ic.com/thermal-tutorial](http://www.maxim-ic.com/thermal-tutorial).

**Note 4:** T<sub>C</sub> is the temperature on the exposed pad of the package. T<sub>A</sub> is the ambient temperature of the device and PCB.

Stresses beyond those listed under "Absolute Maximum Ratings" may cause permanent damage to the device. These are stress ratings only, and functional operation of the device at these or any other conditions beyond those indicated in the operational sections of the specifications is not implied. Exposure to absolute maximum rating conditions for extended periods may affect device reliability.

## DC ELECTRICAL CHARACTERISTICS

(Typical Application Circuit, V<sub>CC</sub> = +4.75V to +5.25V, no input AC signals. T<sub>C</sub> = -40°C to +85°C, unless otherwise noted. Typical values are at V<sub>CC</sub> = +5.0V, T<sub>C</sub> = +25°C, unless otherwise noted.)

| PARAMETER      | SYMBOL          | CONDITIONS           | MIN  | TYP | MAX  | UNITS |
|----------------|-----------------|----------------------|------|-----|------|-------|
| Supply Voltage | V <sub>CC</sub> |                      | 4.75 | 5   | 5.25 | V     |
| Supply Current | I <sub>CC</sub> | Total supply current |      | 105 | 130  | mA    |

## RECOMMENDED AC OPERATING CONDITIONS

| PARAMETER      | SYMBOL          | CONDITIONS  | MIN  | TYP | MAX  | UNITS |
|----------------|-----------------|---|------|-----|------|-------|
| RF Frequency   | f <sub>RF</sub> | (Notes 5, 6)  | 850  |     | 1550 | MHz   |
| LO Frequency   | f <sub>LO</sub> | (Note 5)  | 1200 |     | 2250 | MHz   |
| IF Frequency   | f <sub>IF</sub> | Meeting RF and LO frequency ranges; IF matching components affect the IF frequency range (Note 5) | 50   |     | 1000 | MHz   |
| LO Drive Level | P <sub>LO</sub> |   | -3   |     | +9   | dBm   |

# SiGe, High-Linearity, 850MHz to 1550MHz Up/Downconversion Mixer with LO Buffer

MAX2051

## AC ELECTRICAL CHARACTERISTICS (DOWNCONVERTER OPERATION)

(Typical Application Circuit,  $V_{CC} = +4.75V$  to  $+5.25V$ , RF and LO ports are driven from  $50\Omega$  sources,  $P_{LO} = -3dBm$  to  $+3dBm$ ,  $P_{RF} = 0dBm$ ,  $f_{RF} = 1000MHz$  to  $1250MHz$ ,  $f_{LO} = 1200MHz$  to  $2250MHz$ ,  $f_{IF} = 50MHz$  to  $1000MHz$ ,  $f_{RF} < f_{LO}$ ,  $T_C = -40^\circ C$  to  $+85^\circ C$ . Typical values are at  $V_{CC} = +5.0V$ ,  $P_{RF} = 0dBm$ ,  $P_{LO} = 0dBm$ ,  $f_{RF} = 1200MHz$ ,  $f_{LO} = 1700MHz$ ,  $f_{IF} = 500MHz$ ,  $T_C = +25^\circ C$ , unless otherwise noted.) (Note 7)

| PARAMETER                                     | SYMBOL            | CONDITIONS  | MIN               | TYP       | MAX  | UNITS          |
|---|-------------------|---|-------------------|-----------|------|----------------|
| Conversion Power Loss                         | LC                | $f_{RF} = 1200MHz$ , $f_{LO} = 1700MHz$ ,<br>$f_{IF} = 500MHz$ , $T_C = +25^\circ C$ (Notes 8, 9)   |                   | 7.4       | 9    | dB             |
| Conversion Power Loss Temperature Coefficient | TCL               | $T_C = -40^\circ C$ to $+85^\circ C$  |                   | 0.01      |      | dB/ $^\circ C$ |
| Conversion Power Loss Variation vs. Frequency | $\Delta LC$       | $f_{LO} = 1200MHz$ to $2250MHz$   |                   | $\pm 0.5$ |      | dB             |
| Noise Figure                                  | NF <sub>SSB</sub> | Single sideband   |                   | 7.8       |      | dB             |
| Input 1dB Compression Point                   | IP <sub>1dB</sub> |   |                   | 24        |      | dBm            |
| Third-Order Input Intercept Point             | IIP3              | $V_{CC} = +5.0V$ ,<br>$f_{RF1} = 1200MHz$ ,<br>$f_{RF2} = 1201MHz$ ,<br>$P_{RF} = 0dBm$ tone,<br>$f_{LO} = 1562MHz$ , $P_{LO} = 0dBm$ , $T_C = +25^\circ C$ ,<br>$f_{IF} = 362MHz$ (Notes 8, 9)               | 33                | 35        |      | dBm            |
| 2RF-LO Spurious Rejection                     | 2 x 1             | Single tone, $f_{RF} = 1200MHz$ ,<br>$f_{IF} = 192.5MHz$ to $857.5MHz$ ,<br>$f_{LO} = 1392.5MHz$ to $2057.5MHz$ ,<br>$P_{LO} = +3dBm$ , resultant<br>$f_{SPUR} = 1007.5MHz$ to $342.5MHz$<br>(Notes 8, 9, 10) | $P_{RF} = -14dBm$ | 73        | 88   | dBc            |
|   |                   |   | $P_{RF} = -10dBm$ | 69        | 84   |                |
|   |                   |   | $P_{RF} = 0dBm$   | 59        | 74   |                |
|   |                   | Single tone, $f_{RF} = 1200MHz$ ,<br>$f_{IF} = 857.5MHz$ to $1000MHz$ ,<br>$f_{LO} = 2057.5MHz$ to $2200MHz$ ,<br>$P_{LO} = +3dBm$ , resultant<br>$f_{SPUR} = 342.5MHz$ to $200MHz$<br>(Notes 8, 9, 10)       | $P_{RF} = -14dBm$ | 74        | 78   |                |
|   |                   |   | $P_{RF} = -10dBm$ | 70        | 74   |                |
|   |                   |   | $P_{RF} = 0dBm$   | 60        | 64   |                |
| 2LO-2RF Spurious Rejection                    | 2 x 2             | Single tone, $f_{RF} = 1200MHz$ ,<br>$f_{IF} = 97.5MHz$ to $430MHz$ ,<br>$f_{LO} = 1297.5MHz$ to $1630MHz$ ,<br>$P_{LO} = +3dBm$ , resultant<br>$f_{SPUR} = 195MHz$ to $860MHz$<br>(Notes 8, 9, 10)           | $P_{RF} = -14dBm$ | 68        | 79   | dBc            |
|   |                   |   | $P_{RF} = -10dBm$ | 64        | 75   |                |
|   |                   |   | $P_{RF} = 0dBm$   | 54        | 65   |                |
|   |                   | Single tone, $f_{RF} = 1200MHz$ ,<br>$f_{IF} = 430MHz$ to $525MHz$ ,<br>$f_{LO} = 1630MHz$ to $1725MHz$ ,<br>$P_{LO} = +3dBm$ , resultant<br>$f_{SPUR} = 860MHz$ to $1050MHz$<br>(Notes 8, 9, 10)             | $P_{RF} = -14dBm$ | 71.5      | 77.4 |                |
|   |                   |   | $P_{RF} = -10dBm$ | 67.5      | 73.4 |                |
|   |                   |   | $P_{RF} = 0dBm$   | 57.5      | 63.4 |                |

# SiGe, High-Linearity, 850MHz to 1550MHz Up/Downconversion Mixer with LO Buffer

## AC ELECTRICAL CHARACTERISTICS (DOWNCONVERTER OPERATION) (continued)

(Typical Application Circuit,  $V_{CC} = +4.75V$  to  $+5.25V$ , RF and LO ports are driven from  $50\Omega$  sources,  $P_{LO} = -3dBm$  to  $+3dBm$ ,  $P_{RF} = 0dBm$ ,  $f_{RF} = 1000MHz$  to  $1250MHz$ ,  $f_{LO} = 1200MHz$  to  $2250MHz$ ,  $f_{IF} = 50MHz$  to  $1000MHz$ ,  $f_{RF} < f_{LO}$ ,  $T_C = -40^\circ C$  to  $+85^\circ C$ . Typical values are at  $V_{CC} = +5.0V$ ,  $P_{RF} = 0dBm$ ,  $P_{LO} = 0dBm$ ,  $f_{RF} = 1200MHz$ ,  $f_{LO} = 1700MHz$ ,  $f_{IF} = 500MHz$ ,  $T_C = +25^\circ C$ , unless otherwise noted.) (Note 7)

| PARAMETER                  | SYMBOL   | CONDITIONS   | MIN               | TYP   | MAX   | UNITS    |
|----------------------------|----------|--|-------------------|-------|-------|----------|
| 3LO-3RF Spurious Rejection | 3 x 3    | Single tone, $f_{RF} = 1200MHz$ ,<br>$50MHz < f_{IF} < 1000MHz$ ,<br>$1250MHz < f_{LO} < 2200MHz$<br>(Notes 8, 9)  | $P_{RF} = -14dBm$ | 87.5  | 101   | dBc      |
|                            |          |  | $P_{RF} = -10dBm$ | 79.5  | 93    |          |
|                            |          |  | $P_{RF} = 0dBm$   | 59.5  | 73    |          |
| LO Leakage at RF Port      |          | $P_{LO} = +3dBm$ (Notes 6, 8)  |                   | -33.5 | -27.5 | dBm      |
| LO Leakage at IF Port      |          | $P_{LO} = +3dBm$ (Notes 8, 9)  |                   | -26.3 | -22.9 | dBm      |
| RF-to-IF Isolation         |          | $f_{RF} = 1200MHz$ , $P_{LO} = +3dBm$ (Notes 8, 9)   | 24                | 51    |       | dB       |
| RF Input Impedance         | $Z_{RF}$ |  |                   | 50    |       | $\Omega$ |
| RF Input Return Loss       |          | LO on and IF terminated with a matched impedance   |                   | 12    |       | dB       |
| LO Input Impedance         | $Z_{LO}$ |  |                   | 50    |       | $\Omega$ |
| LO Input Return Loss       |          | RF and IF terminated with a matched impedance (Note 11)  |                   | 11    |       | dB       |
| IF Output Impedance        | $Z_{IF}$ | Nominal differential impedance at the IC's IF outputs  |                   | 50    |       | $\Omega$ |
| IF Output Return Loss      |          | RF terminated into $50\Omega$ , LO driven by $50\Omega$ source, IF transformed to $50\Omega$ single-ended using external components shown in the Typical Application Circuit |                   | 15    |       | dB       |

# SiGe, High-Linearity, 850MHz to 1550MHz Up/Downconversion Mixer with LO Buffer

MAX2051

## AC ELECTRICAL CHARACTERISTICS (UPCONVERTER OPERATION)

(Typical Application Circuit, RF and LO ports are driven from 50Ω sources,  $f_{RF} < f_{LO}$ . Typical values are at  $V_{CC} = +5.0V$ ,  $P_{IF} = 0dBm$ ,  $P_{LO} = 0dBm$ ,  $f_{RF} = 1250MHz$ ,  $f_{LO} = 1600MHz$ ,  $f_{IF} = 350MHz$ ,  $T_C = +25^\circ C$ , unless otherwise noted.) (Note 7)

| PARAMETER                         | SYMBOL | CONDITIONS   | MIN | TYP   | MAX | UNITS |
|-----------------------------------|--------|--|-----|-------|-----|-------|
| Conversion Power Loss             | $L_C$  |  |     | 7.5   |     | dB    |
| Third-Order Input Intercept Point | IIP3   | $f_{IF1} = 350MHz$ , $f_{IF2} = 351MHz$ , $P_{IF} = 0dBm/tone$ |     | 33.4  |     | dBm   |
| LO-2IF Spurious Rejection         |        |  |     | 61    |     | dBc   |
| LO+2IF Spurious Rejection         |        |  |     | 63.3  |     | dBc   |
| LO-3IF Spurious Rejection         |        |  |     | 78    |     | dBc   |
| LO+3IF Spurious Rejection         |        |  |     | 79    |     | dBc   |
| LO Leakage at RF Port             |        | $P_{LO} = +3dBm$   |     | -35.7 |     | dBm   |
| IF Leakage at RF Port             |        |  |     | -52   |     | dBm   |
| RF Return Loss                    |        |  |     | 12.3  |     | dB    |
| IF Input Return Loss              |        | $f_{LO} = 1200MHz$   |     | 18    |     | dB    |

- Note 5:** Operation outside this range is possible, but with degraded performance of some parameters. See the *Typical Operating Characteristics* section.
- Note 6:** Not production tested.
- Note 7:** All values reflect losses of external components, including a 0.6dB loss at  $f_{IF} = 350MHz$  and a 0.8dB loss at  $f_{IF} = 1000MHz$  due to the 1:1 transformer. Output measurements were taken at IF outputs of the *Typical Application Circuit*.
- Note 8:** Guaranteed by design and characterization.
- Note 9:** 100% production tested for functionality.
- Note 10:** Additional improvements (of up to 4dB to 6dB) in spurious responses can be made by increasing the LO drive to +6dBm.
- Note 11:** The LO return loss can be improved by tuning C9 to offset any parasitics within the specific application circuit. Typical range of C9 is 10pF to 50pF.

# SiGe, High-Linearity, 850MHz to 1550MHz Up/Downconversion Mixer with LO Buffer

## Typical Operating Characteristics

(Typical Application Circuit, Downconversion mode,  $V_{CC} = +5.0V$ ,  $P_{LO} = 0dBm$ ,  $P_{RF} = 0dBm$ ,  $f_{RF} = 1200MHz$ , LO is high-side injected,  $T_C = +25^\circ C$ , unless otherwise noted.)

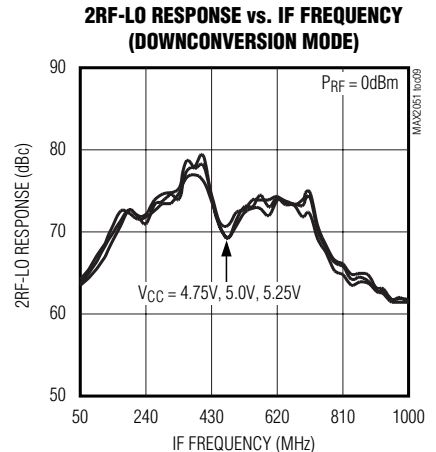
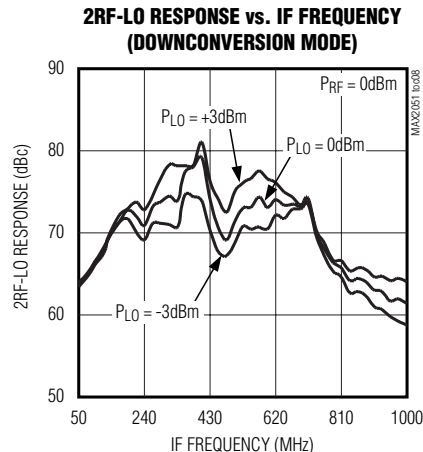
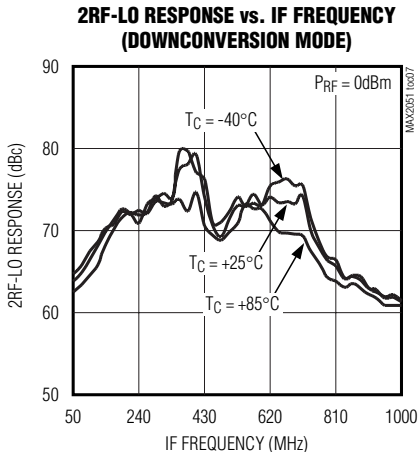
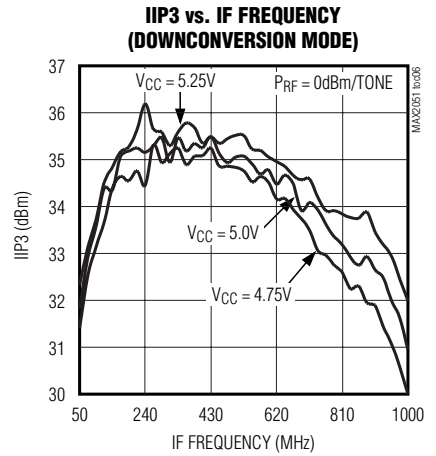
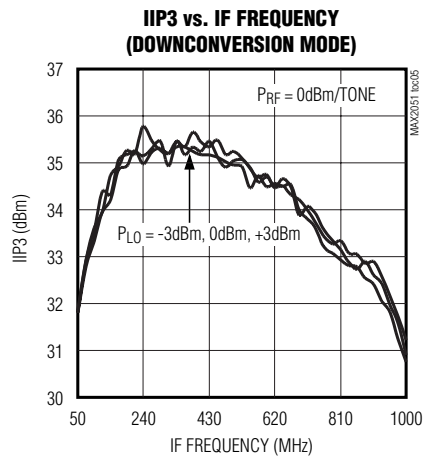
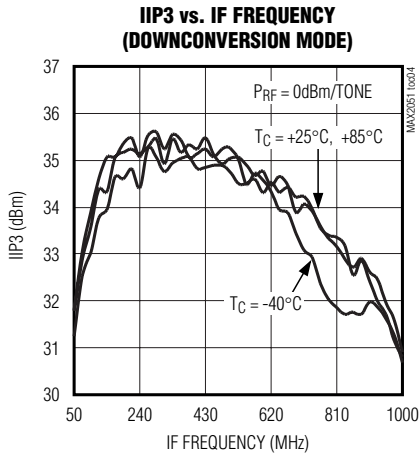
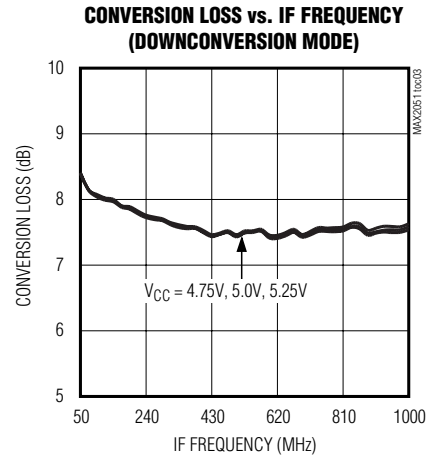
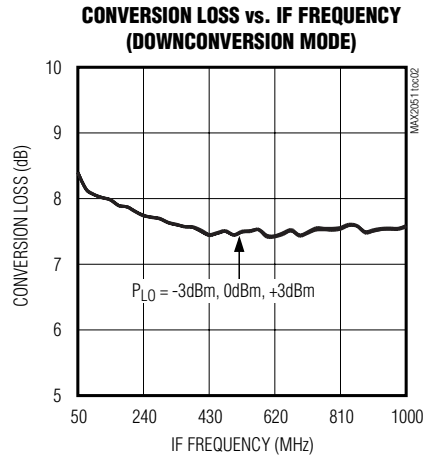
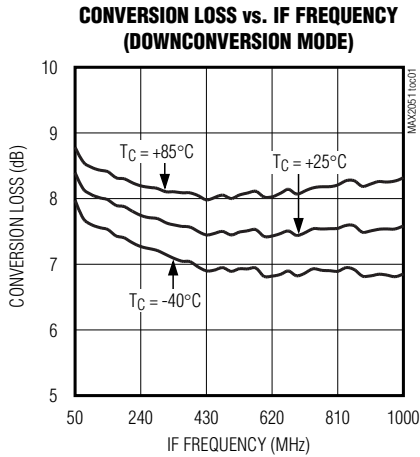

# SiGe, High-Linearity, 850MHz to 1550MHz Up/Downconversion Mixer with LO Buffer

MAX2051

## Typical Operating Characteristics (continued)

(Typical Application Circuit, Downconversion mode,  $V_{CC} = +5.0V$ ,  $P_{LO} = 0dBm$ ,  $P_{RF} = 0dBm$ ,  $f_{RF} = 1200MHz$ , LO is high-side injected,  $T_C = +25^\circ C$ , unless otherwise noted.)

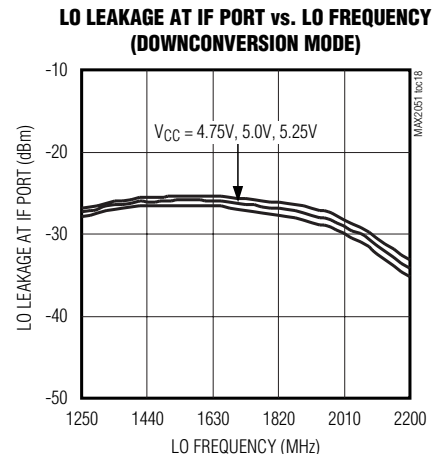
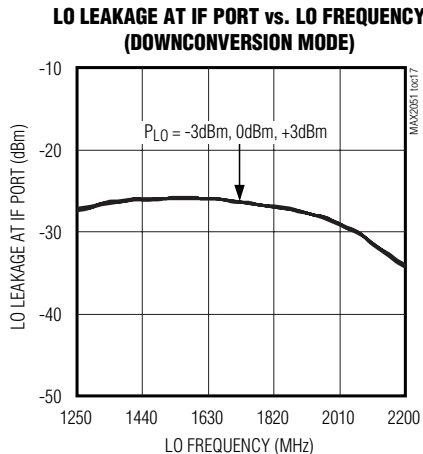
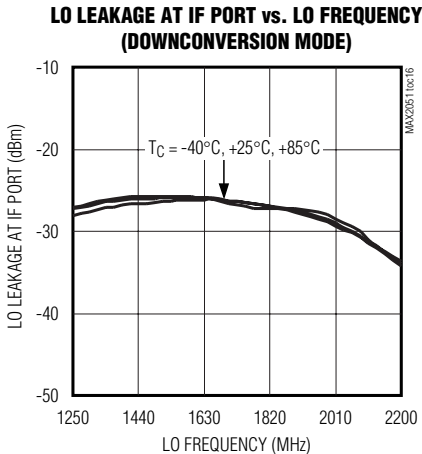
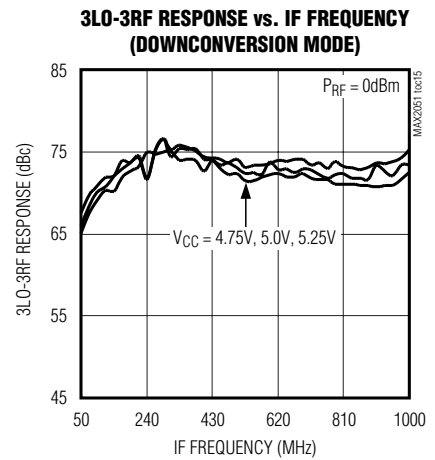
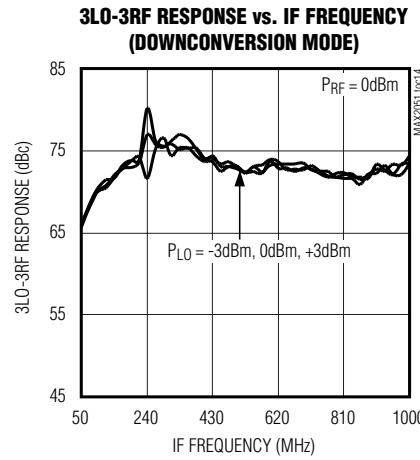
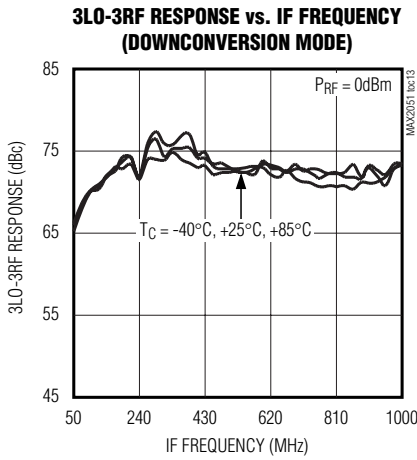
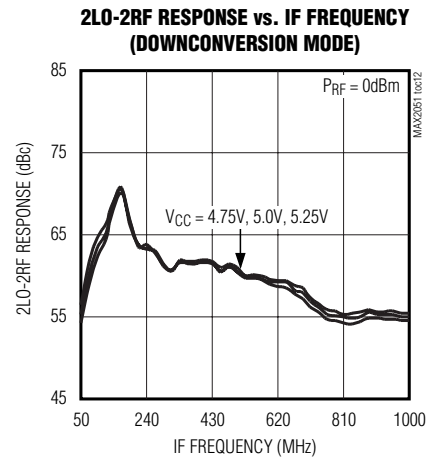
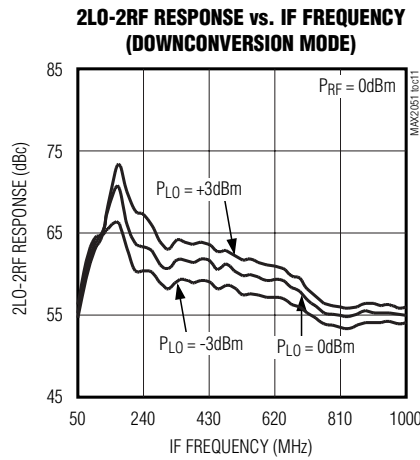
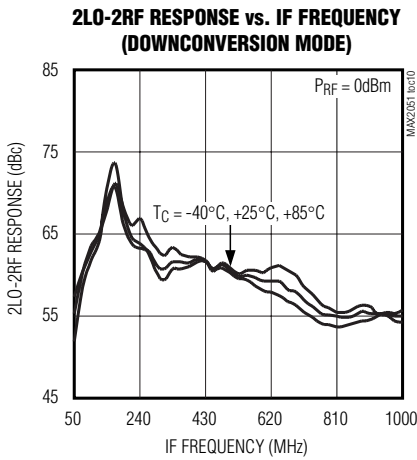

# SiGe, High-Linearity, 850MHz to 1550MHz Up/Downconversion Mixer with LO Buffer

## Typical Operating Characteristics (continued)

(Typical Application Circuit, Downconversion mode,  $V_{CC} = +5.0V$ ,  $P_{LO} = 0dBm$ ,  $P_{RF} = 0dBm$ ,  $f_{RF} = 1200MHz$ , LO is high-side injected,  $T_C = +25^\circ C$ , unless otherwise noted.)

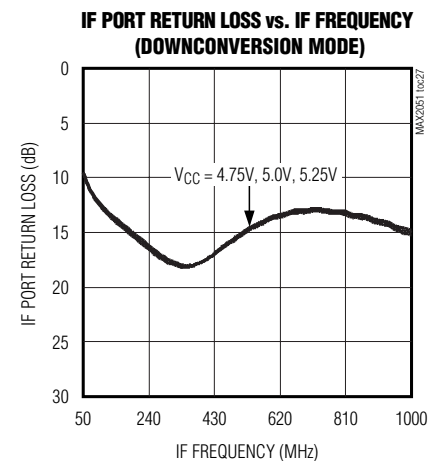
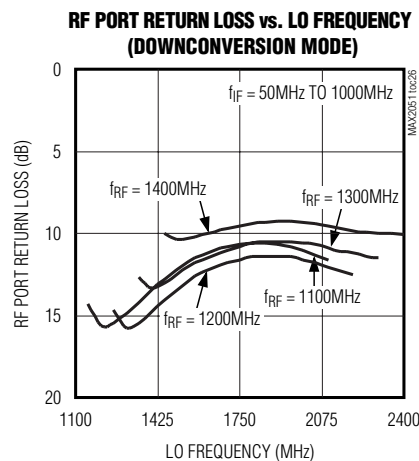
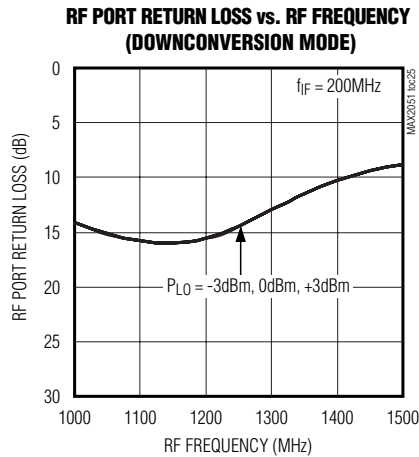
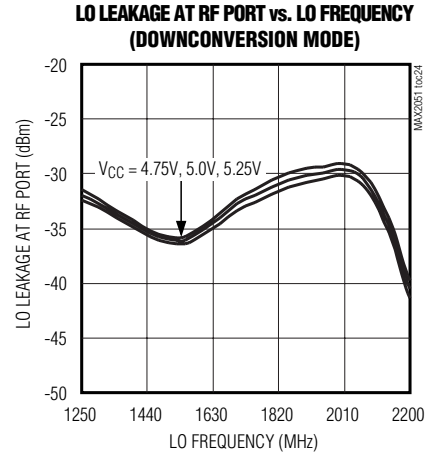
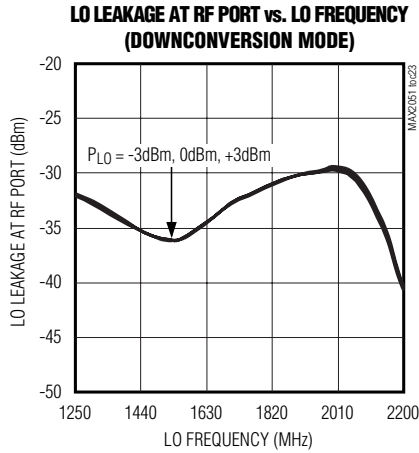
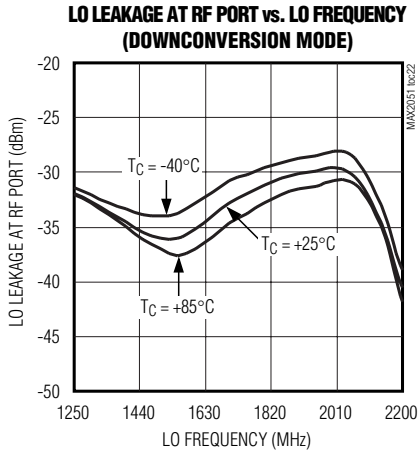
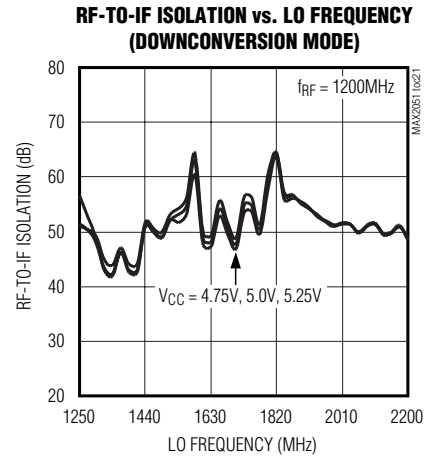
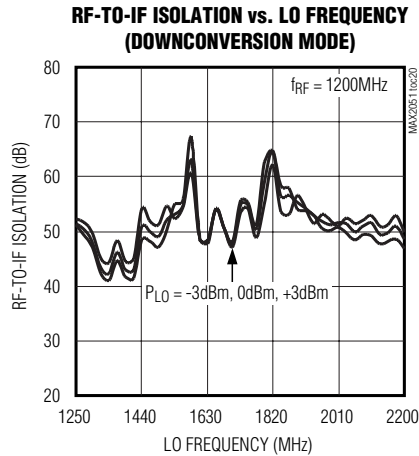
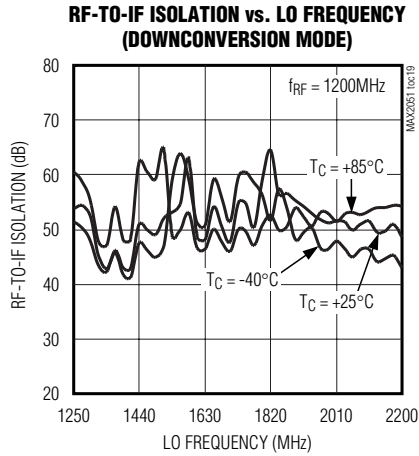

# SiGe, High-Linearity, 850MHz to 1550MHz Up/Downconversion Mixer with LO Buffer

MAX2051

## Typical Operating Characteristics (continued)

(Typical Application Circuit, Downconversion mode,  $V_{CC} = +5.0V$ ,  $P_{LO} = 0dBm$ ,  $P_{RF} = 0dBm$ ,  $f_{RF} = 1200MHz$ , LO is high-side injected,  $T_C = +25^\circ C$ , unless otherwise noted.)

**LO PORT RETURN LOSS vs. LO FREQUENCY (DOWNCONVERSION MODE)**

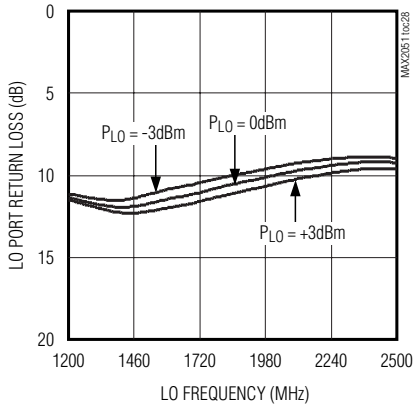

**SUPPLY CURRENT vs. EXPOSED PAD TEMPERATURE (DOWNCONVERSION MODE)**

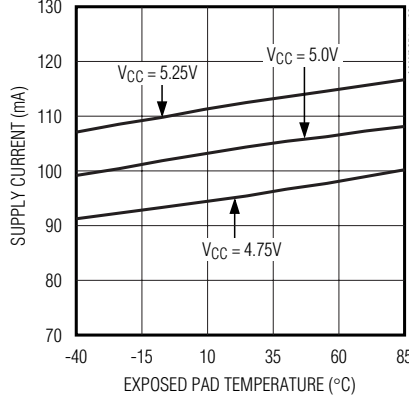

**IIP3 vs. IF FREQUENCY (ALTERNATIVE VALUES OF C2)**

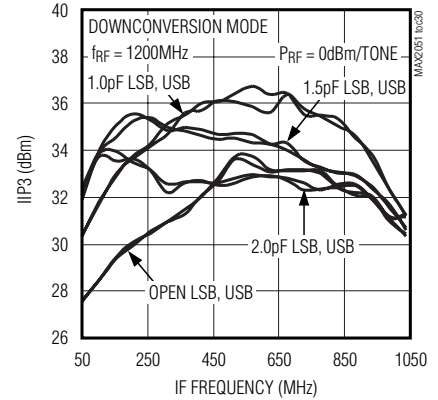

**2RF-LO vs. IF FREQUENCY (ALTERNATIVE VALUES OF C2)**

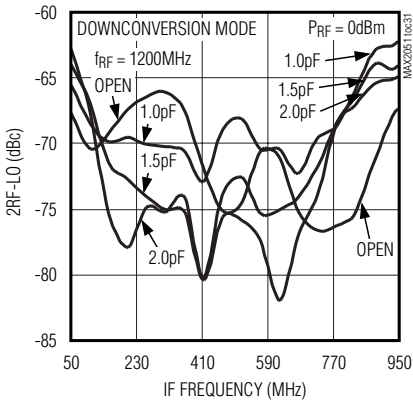

**2LO-2RF vs. IF FREQUENCY (ALTERNATIVE VALUES OF C2)**

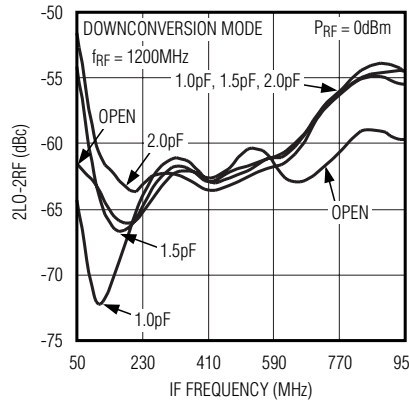

**3LO-3RF vs. IF FREQUENCY (ALTERNATIVE VALUES OF C2)**

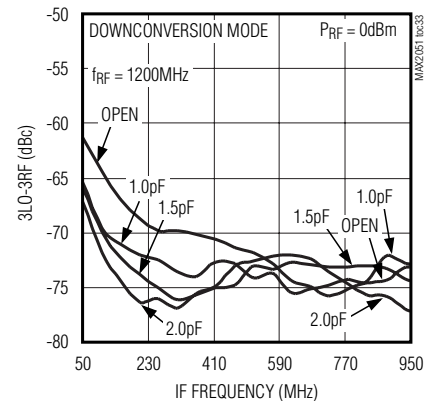

**2RF-LO vs. IF FREQUENCY (VARIOUS LO DRIVE LEVELS)**

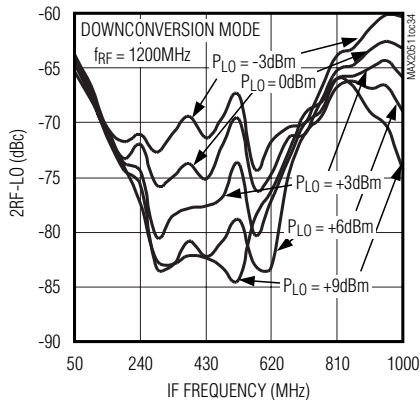

**2LO-2RF vs. IF FREQUENCY (VARIOUS LO DRIVE LEVELS)**

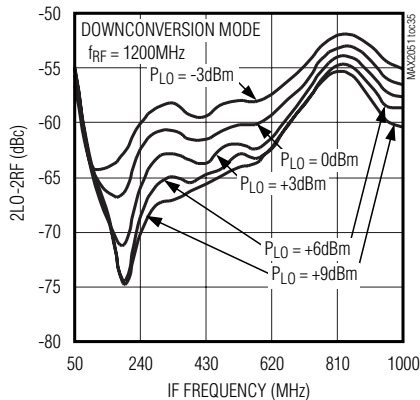

# SiGe, High-Linearity, 850MHz to 1550MHz Up/Downconversion Mixer with LO Buffer

## Typical Operating Characteristics (continued)

(Typical Application Circuit, Upconversion mode,  $V_{CC} = +5.0V$ ,  $P_{LO} = 0dBm$ ,  $P_{IF} = 0dBm$ ,  $f_{IF} = 350MHz$ , LO is high-side injected,  $T_C = +25^\circ C$ , unless otherwise noted.)

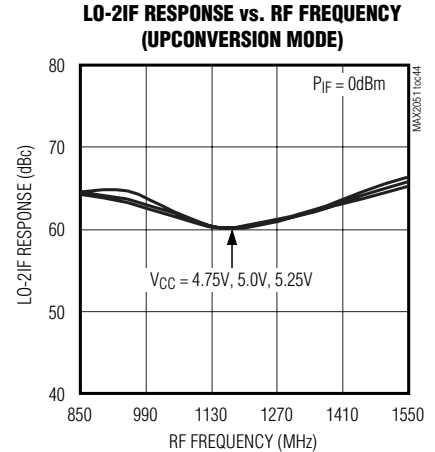
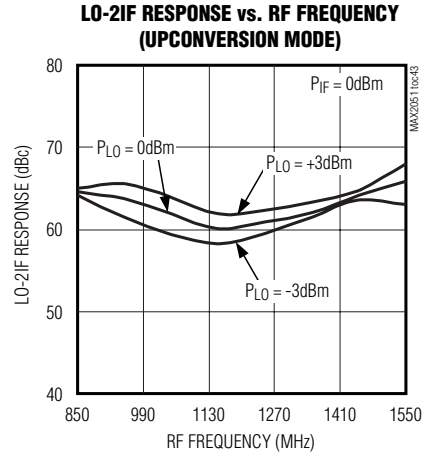
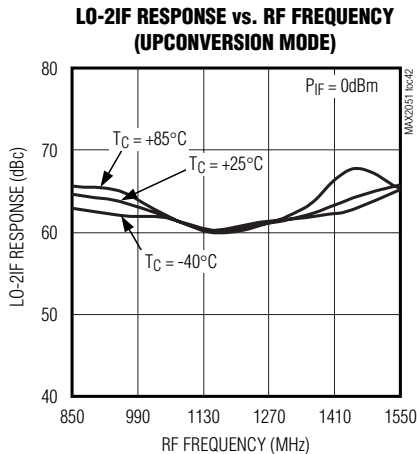
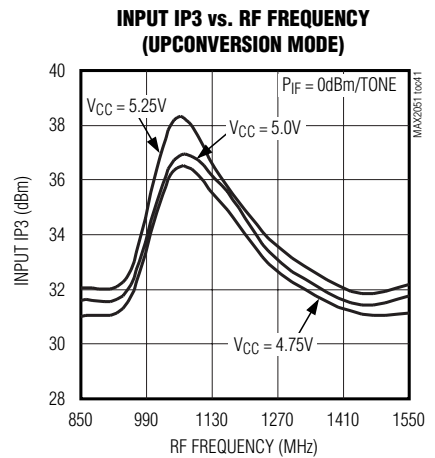
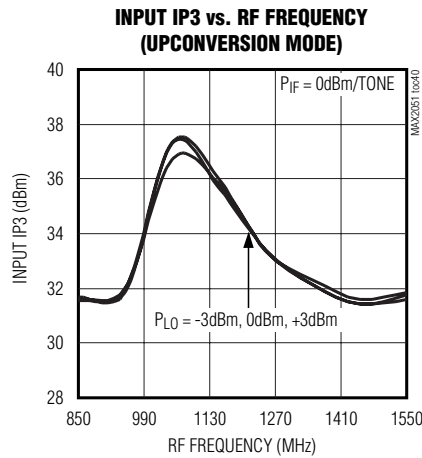
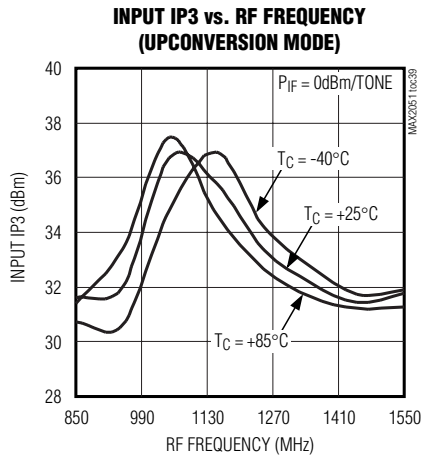
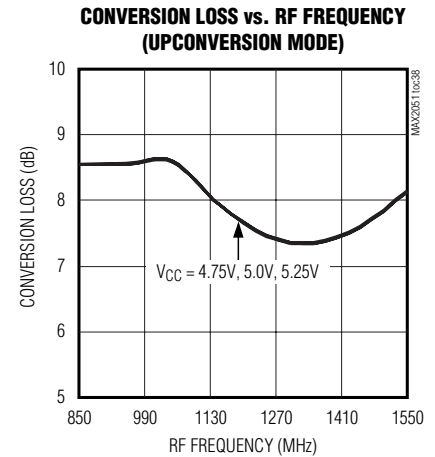
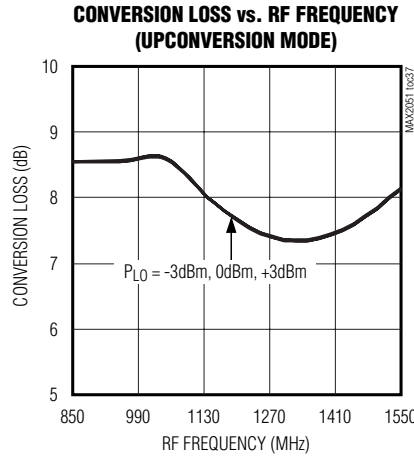
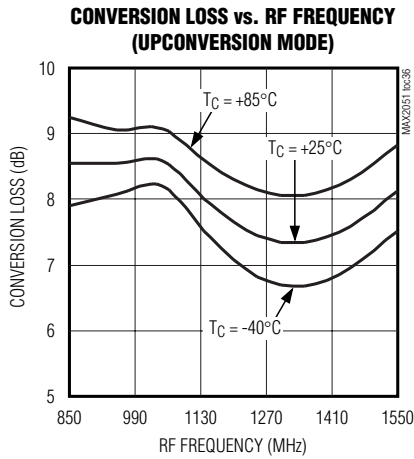

# SiGe, High-Linearity, 850MHz to 1550MHz Up/Downconversion Mixer with LO Buffer

## Typical Operating Characteristics (continued)

(Typical Application Circuit, Upconversion mode,  $V_{CC} = +5.0V$ ,  $P_{LO} = 0dBm$ ,  $P_{IF} = 0dBm$ ,  $f_{IF} = 350MHz$ , LO is high-side injected,  $T_C = +25^\circ C$ , unless otherwise noted.)

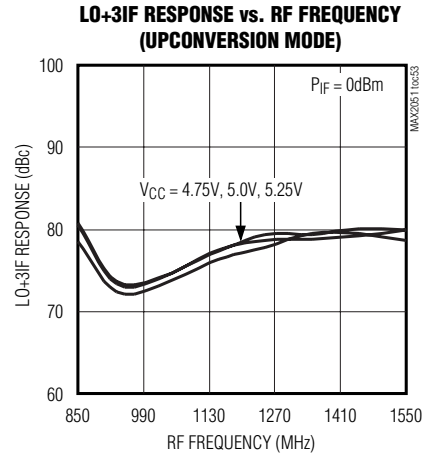
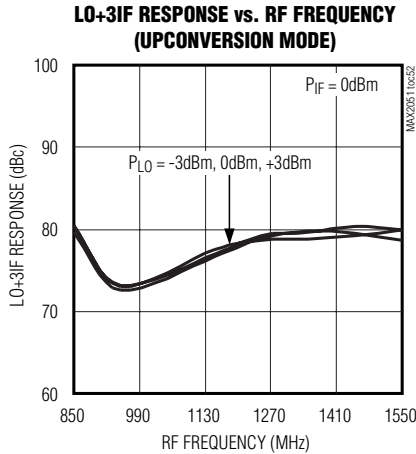
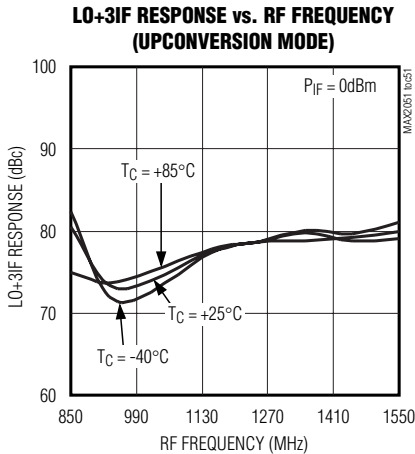
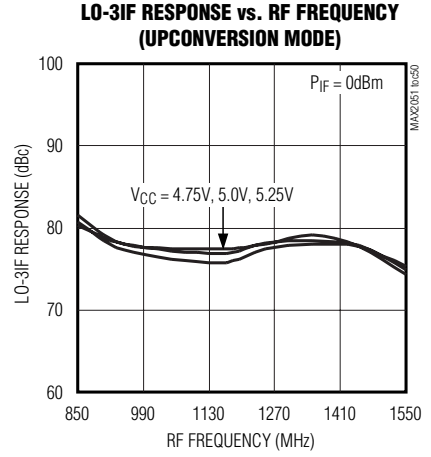
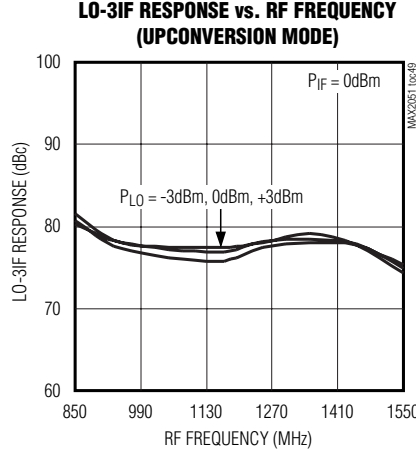
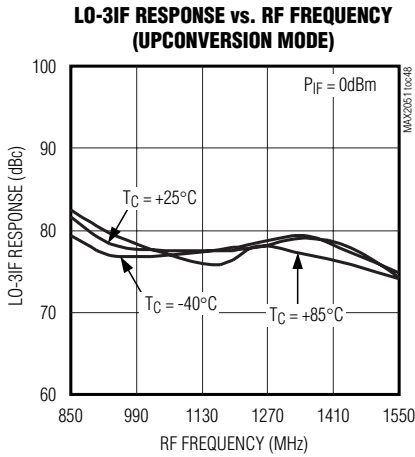
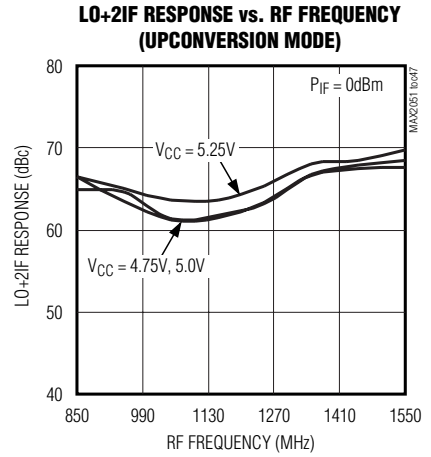
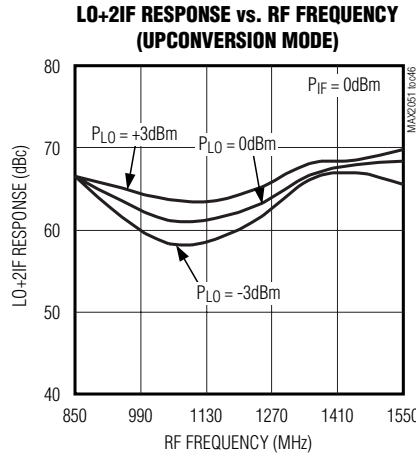
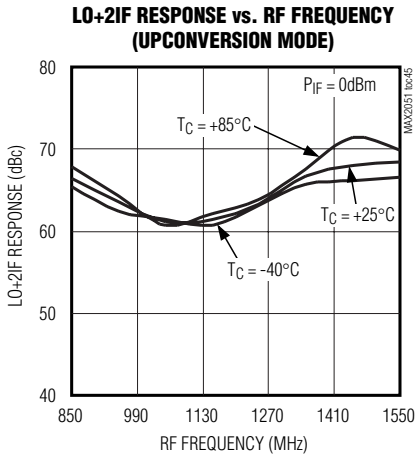

# SiGe, High-Linearity, 850MHz to 1550MHz Up/Downconversion Mixer with LO Buffer

## Typical Operating Characteristics (continued)

(Typical Application Circuit, Upconversion mode,  $V_{CC} = +5.0V$ ,  $P_{LO} = 0dBm$ ,  $P_{IF} = 0dBm$ ,  $f_{IF} = 350MHz$ , LO is high-side injected,  $T_C = +25^\circ C$ , unless otherwise noted.)

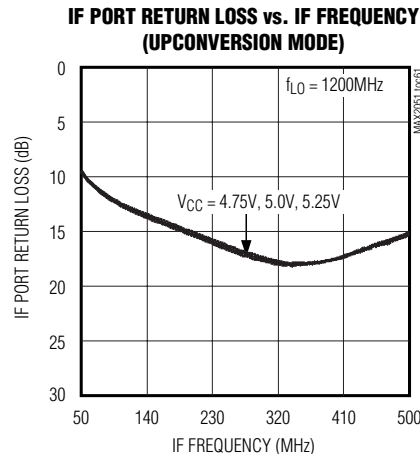
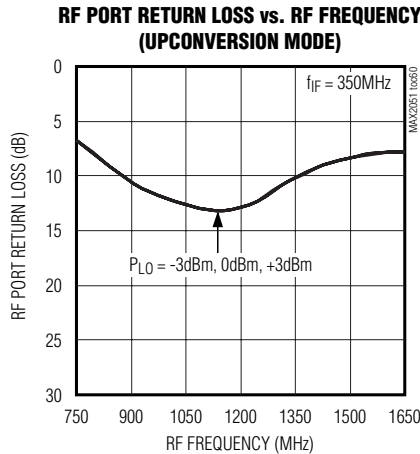
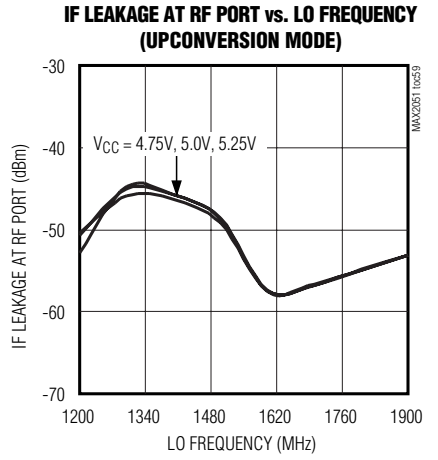
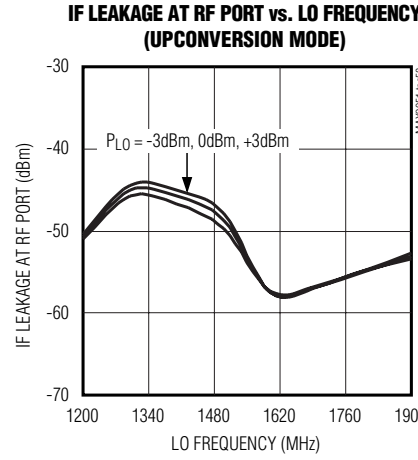
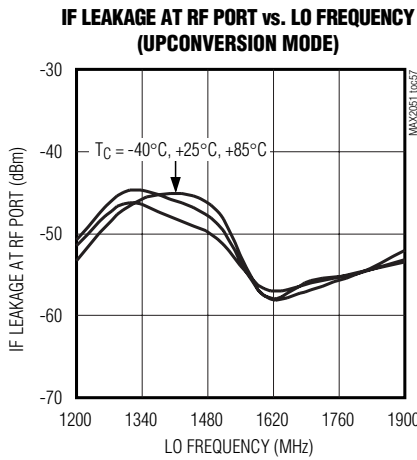
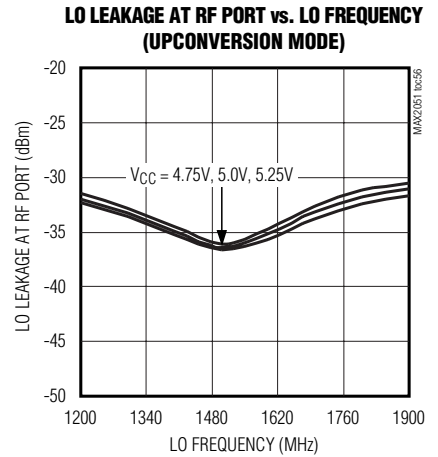
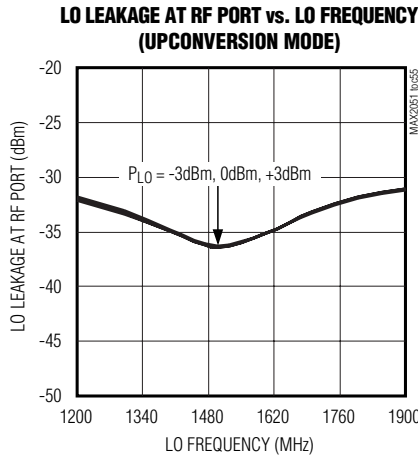
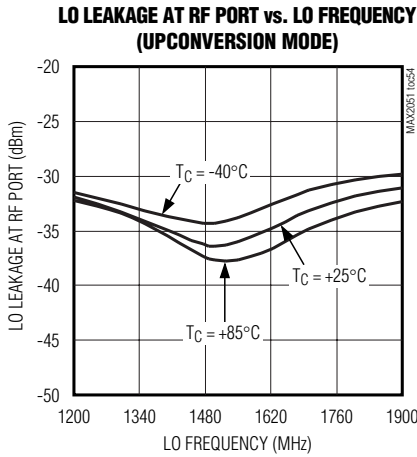

# SiGe, High-Linearity, 850MHz to 1550MHz Up/Downconversion Mixer with LO Buffer

## Typical Operating Characteristics (continued)

(Typical Application Circuit, Upconversion mode,  $V_{CC} = +5.0V$ ,  $P_{LO} = 0dBm$ ,  $P_{IF} = 0dBm$ ,  $f_{IF} = 350MHz$ , LO is high-side injected,  $T_C = +25^\circ C$ , unless otherwise noted.)

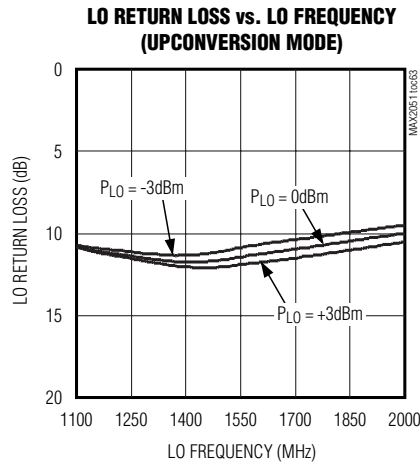
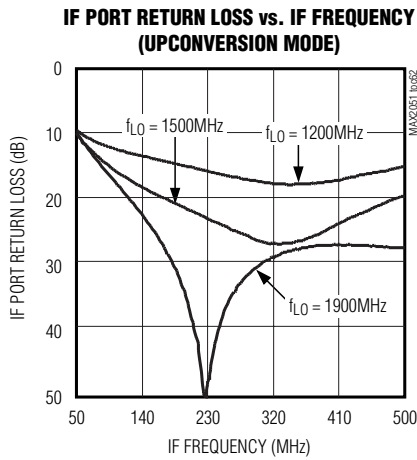

## Pin Description

| PIN                    | NAME     | FUNCTION   |
|------------------------|----------|--|
| 1                      | RF       | Single-Ended 50Ω RF Input. Internally matched and DC shorted to GND through a balun. Requires an input DC-blocking capacitor.  |
| 2-5, 9, 10, 11, 13, 14 | GND      | Ground. Internally connected to the exposed pad. Connect all ground pins and the exposed pad (EP) together.  |
| 6, 8, 15               | VCC      | Power Supply. Bypass to GND with capacitors as close as possible to the pin (see the <i>Typical Application Circuit</i> ).   |
| 7                      | LOBIAS   | LO Amplifier Bias Control. Output bias resistor for the LO buffer. Connect a 61.9Ω ±1% resistor from LOBIAS to VCC to set the bias current for the main LO amplifier.  |
| 12                     | LO       | Local Oscillator Input. This input is internally matched to 50Ω. Requires an input DC-blocking capacitor.  |
| 16, 17                 | IF+, IF- | Differential IF Output   |
| 18, 19, 20             | GND      | Ground. Not internally connected. Ground these pins or leave unconnected.  |
| —                      | EP       | Exposed Pad. Internally connected to GND. Solder this exposed pad to a PCB pad that uses multiple ground vias to provide heat transfer out of the device into the PCB ground planes. These multiple ground vias are also required to achieve the noted RF performance. |

# SiGe, High-Linearity, 850MHz to 1550MHz Up/Downconversion Mixer with LO Buffer

## Detailed Description

The MAX2051 high-linearity up/downconversion mixer provides +35dBm of IIP3, with a typical 7.8dB noise figure (NF) and 7.4dB conversion loss. The integrated baluns and matching circuitry allow for 50 $\Omega$  single-ended interfaces to the RF and the LO ports. The integrated LO buffer provides a high drive level to the mixer core, reducing the LO drive required at the MAX2051's input to a -3dBm to +3dBm range. The IF port incorporates a differential output, which is ideal for providing enhanced 2RF-LO and 2LO-2RF performance. 2RF-LO rejection is typically 88dB and 2LO-2RF rejection is typically 79dB at an RF drive level of -14dBm.

Specifications are guaranteed over broad frequency ranges to allow for use in VOD, DOCSIS-compatible Edge QAM modulation, and CMTS. The MAX2051 is specified to operate over an RF input range of 850MHz to 1550MHz, an LO range of 1200MHz to 2250MHz, and an IF range of 50MHz to 1000MHz.

### RF Port and Balun

The MAX2051 RF input provides a 50 $\Omega$  match when combined with a series 47pF DC-blocking capacitor. This DC-blocking capacitor is required because the input is internally DC shorted to ground through the on-chip balun. The RF port input return loss is typically 12dB over the RF frequency range of 1000MHz to 1250MHz.

### LO Inputs, Buffer, and Balun

The MAX2051 is optimized for high-side LO injection applications with a 1200MHz to 2550MHz LO frequency range. The LO input is internally matched to 50 $\Omega$ , requiring only a 47pF DC-blocking capacitor. A two-stage internal LO buffer allows for a -3dBm to +3dBm LO input power range. The on-chip low-loss balun, along with an LO buffer, drives the double-balanced mixer. All interfacing and matching components from the LO inputs to the IF outputs are integrated on-chip.

### High-Linearity Mixer

The core of the MAX2051 is a double-balanced, high-performance passive mixer. Exceptional linearity is provided by the large LO swing from the on-chip LO buffer. IIP3, 2RF-LO rejection, and noise figure performance are typically +35dBm, 88dBc, and 7.8dB, respectively.

### Differential IF Output

The MAX2051 has an IF frequency range of 50MHz to 1000MHz. The device's differential ports are ideal for providing enhanced 2RF-LO performance. Single-ended IF applications require a 1:1 (impedance ratio) balun to transform the 50 $\Omega$  differential IF impedance to a 50 $\Omega$  single-ended system.

## Applications Information

### Input and Output Matching

The RF and LO ports are designed to operate in a 50 $\Omega$  system. Use DC blocks at RF and LO inputs to isolate the ports from external DC while providing some reactive tuning. The IF output impedance is 50 $\Omega$  (differential). For evaluation, an external low-loss 1:1 balun transforms this impedance to a 50 $\Omega$  single-ended output (see the *Typical Application Circuit*).

### Externally Adjustable Bias

Bias currents for the LO buffer is optimized by fine-tuning resistor R1. The value for R1, as listed in Table 1, represents the nominal value, which yields the optimal linearity/performance trade off. Use larger value resistors (up to 125 $\Omega$ ) to reduce power dissipation at the expense of some performance loss. Use smaller value resistors (down to 0 $\Omega$ ) to increase the linearity of the device at the expense of more power. Contact the factory for details concerning recommended power reduction vs. performance trade-offs. If  $\pm 1\%$  resistors are not readily available,  $\pm 5\%$  resistors can be substituted.

**Table 1. Component Values**

| DESIGNATION | QTY | DESCRIPTION                              | SUPPLIER                               |
|-------------|-----|--|--|
| C1, C9      | 2   | 47pF microwave capacitors (0402)         | Murata Electronics North America, Inc. |
| C2          | 1   | 1.3pF microwave capacitor (0402)         | Murata Electronics North America, Inc. |
| C3, C4      | 2   | 150pF microwave capacitors (0402)        | Murata Electronics North America, Inc. |
| C5, C7, C10 | 3   | 100pF microwave capacitors (0402)        | Murata Electronics North America, Inc. |
| C6, C8, C11 | 3   | 0.01 $\mu$ F microwave capacitors (0402) | Murata Electronics North America, Inc. |
| R1          | 1   | 61.9 $\Omega$ $\pm 1\%$ resistor (0402)  | Digi-Key Corp.                         |
| T1          | 1   | 1:1 transformer (50:50) MABACT0060       | M/A-Com, Inc.                          |
| U1          | 1   | MAX2051 IC (20 TQFN-EP)                  | Maxim Integrated Products, Inc.        |

# SiGe, High-Linearity, 850MHz to 1550MHz Up/Downconversion Mixer with LO Buffer

## **IIP3 and Spurious Optimization by External IF Tuning**

IIP3 linearity and spurious performance can be further optimized by modifying the capacitive loading on the IF ports. The default component value of 1.3pF for C2 (listed in Table 1) was chosen to provide the best overall IIP3 linearity response over the entire 50MHz to 1000MHz band. Alternative capacitor values can be chosen to improve the device's 2RF-LO, 2LO-2RF, and 3LO-3RF spurious responses at the expense of overall IIP3 performance. See the relevant curves in the *Typical Operating Characteristics* section to evaluate the IIP3 vs. spurious performance trade-offs.

## **Spurious Optimization by Increased LO Drive Levels**

The MAX2051's 2RF-LO, 2LO-2RF, and 3LO-3RF spurious performance can also be improved by increasing the LO drive level to the device. The *Typical Application Circuit* calls for a nominal LO drive level of 0dBm. However, enhancements in the device's spurious performance are possible with increased drive levels extending up to +9dBm. See the relevant curves in the *Typical Operating Characteristics* section to evaluate the spurious performance vs. LO drive level trade-offs.

## **Layout Considerations**

A properly designed PCB is an essential part of any RF/microwave circuit. Keep RF signal lines as short as possible to reduce losses, radiation, and inductance.

The load impedance presented to the mixer must be such that any capacitance from both IF- and IF+ to ground is minimized. For the best performance, route the ground pin traces directly to the exposed pad under the package. The PCB exposed pad **MUST** be connected to the ground plane of the PCB. It is suggested that multiple vias be used to connect this pad to the lower level ground planes. This method provides a good RF/thermal-conduction path for the device. Solder the exposed pad on the bottom of the device package to the PCB. The MAX2051 evaluation kit can be used as a reference for board layout. Gerber files are available upon request at [www.maxim-ic.com](http://www.maxim-ic.com).

## **Power-Supply Bypassing**

Proper voltage supply bypassing is essential for high-frequency circuit stability. Bypass each VCC pin with the capacitors shown in the *Typical Application Circuit* and see Table 1 for descriptions.

## **Exposed Pad RF/Thermal Considerations**

The exposed pad (EP) of the MAX2051's 20-pin thin QFN package provides a low thermal-resistance path to the die. It is important that the PCB on which the MAX2051 is mounted be designed to conduct heat from the EP. In addition, provide the EP with a low-inductance path to electrical ground. The EP **MUST** be soldered to a ground plane on the PCB, either directly or through an array of plated via holes.

# SiGe, High-Linearity, 850MHz to 1550MHz Up/Downconversion Mixer with LO Buffer

## Typical Application Circuit

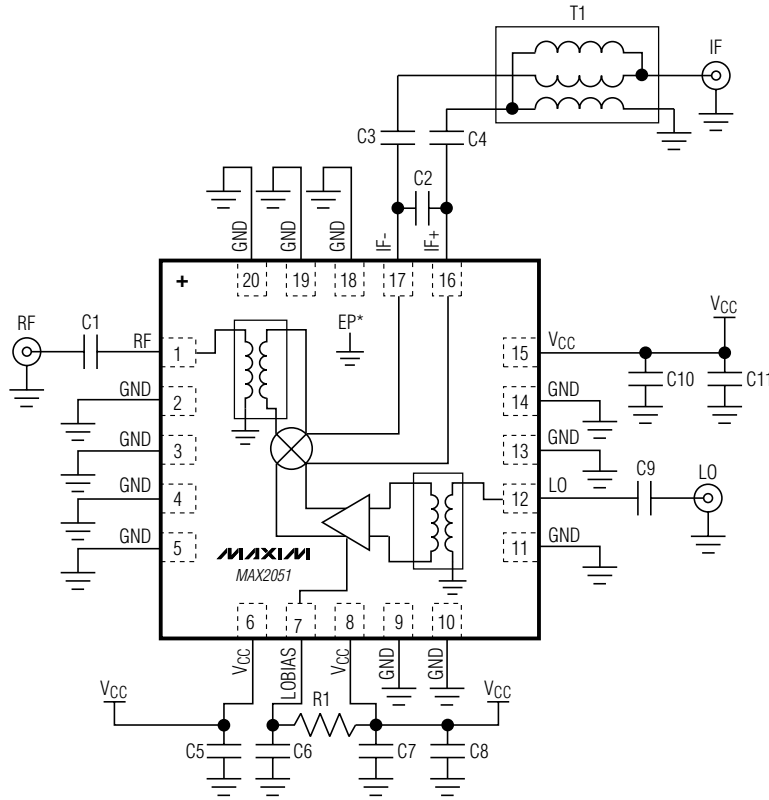

\*EXPOSED PAD. CONNECT EP TO GND.

### Chip Information

PROCESS: SiGe BiCMOS

### Package Information

For the latest package outline information and land patterns, go to [www.maxim-ic.com/packages](http://www.maxim-ic.com/packages).

| PACKAGE TYPE   | PACKAGE CODE | DOCUMENT NO.            |
|----------------|--------------|-------------------------|
| 20 Thin QFN-EP | T2055+3      | <a href="#">21-0140</a> |

Maxim cannot assume responsibility for use of any circuitry other than circuitry entirely embodied in a Maxim product. No circuit patent licenses are implied. Maxim reserves the right to change the circuitry and specifications without notice at any time.

16 **Maxim Integrated Products, 120 San Gabriel Drive, Sunnyvale, CA 94086 408-737-7600**