

2MHz, High-Brightness LED Drivers with Integrated MOSFET and High-Side Current Sense

General Description

The MAX16832A/MAX16832C step-down constant-current high-brightness LED (HB LED) drivers provide a cost-effective design solution for automotive interior/exterior lighting, architectural and ambient lighting, LED bulbs, and other LED illumination applications.

The MAX16832A/MAX16832C operate from a +6.5V to +65V input voltage range and can provide an output current up to 700mA, if operated up to a temperature of +125°C, or up to a 1A if operated up to a temperature of +105°C. A high-side current-sense resistor adjusts the output current, and a dedicated pulse-width modulation (PWM) input enables pulsed LED dimming over a wide range of brightness levels.

These devices are well suited for applications requiring a wide input voltage range. The high-side current sensing and an integrated current-setting circuitry minimize the number of external components while delivering an average output current with $\pm 3\%$ accuracy. A hysteretic control method ensures excellent input supply rejection and fast response during load transients and PWM dimming. The MAX16832A allows 10% current ripple, and the MAX16832C allows 30% current ripple. Both devices operate up to a 2MHz switching frequency, thus allowing the use of small-sized components.

The MAX16832A/MAX16832C offer an analog dimming feature that reduces the output current by applying an external DC voltage below the internal 2V threshold voltage from TEMP_I to GND. TEMP_I also sources 25 μ A to a negative temperature coefficient (NTC) thermistor connected between TEMP_I and GND, thus providing an analog thermal-foldback feature that reduces the LED current when the temperature of the LED string exceeds a specified temperature point. Additional features include thermal-shutdown protection.

The MAX16832A/MAX16832C operate over the -40°C to +125°C automotive temperature range and are available in a thermally enhanced 8-pin SO package.

Applications

Architectural, Industrial, and Ambient Lighting
Automotive RCL, DRL, and Fog Lights
Heads-Up Displays
Indicator and Emergency Lighting
MR16 and MR111 LED Lights

Pin Configuration appears at end of data sheet.

Features

- ◆ High-Efficiency Solution
- ◆ 6.5V to 65V Input Voltage Range
- ◆ Output Current Up to 1A
- ◆ On-Board 65V, 0.45 Ω Power MOSFET
- ◆ Hysteretic Control: Up to 2MHz Switching Frequency
- ◆ $\pm 3\%$ LED Current Accuracy
- ◆ 200mV Current-Sense Reference
- ◆ Resistor-Programmable Constant LED Current
- ◆ Integrated High-Side Current Sense
- ◆ Thermal-Foldback Protection/Linear Dimming
- ◆ Thermal-Shutdown Protection
- ◆ Available in a Thermally Enhanced 8-Pin SO Package
- ◆ -40°C to +125°C Operating Temperature Range

Ordering Information

PART	TEMP RANGE	PIN-PACKAGE
MAX16832AASA+	-40°C to +125°C	8 SO-EP*
MAX16832CASA+	-40°C to +125°C	8 SO-EP*

+Denotes a lead(Pb)-free/RoHS-compliant package.

*EP = Exposed pad.

Typical Application Circuit

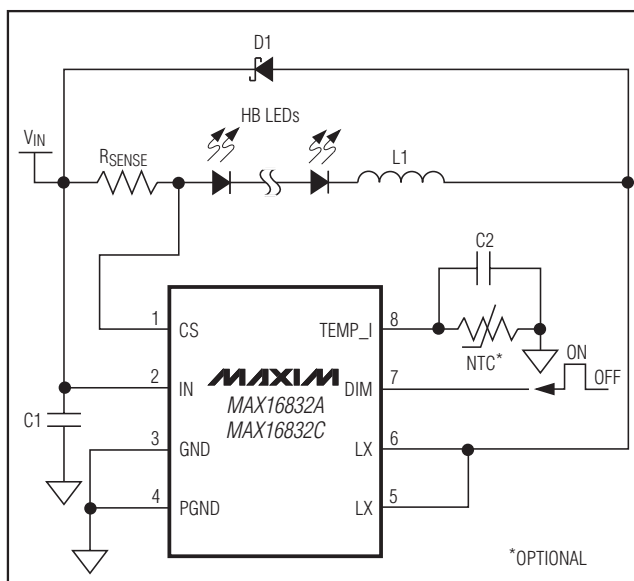

*OPTIONAL

2MHz, High-Brightness LED Drivers with Integrated MOSFET and High-Side Current Sense

ABSOLUTE MAXIMUM RATINGS

IN, CS, LX, DIM to GND	-0.3V to +70V
TEMP_I to GND	-0.3V to +6V
PGND to GND	-0.3V to +0.3V
CS to IN	-0.3V to +0.3V
Maximum Current into Any Pin (except IN, LX, and PGND)	20mA
Continuous Power Dissipation (T _A = +70°C) 8-Pin SO (derate 18.9mW/°C above +70°C)	1509.4mW

Operating Temperature Range	-40°C to +125°C
700mA (max) Output Current	-40°C to +105°C
1A (max) Output Current	-40°C to +105°C
Junction Temperature	+150°C
Storage Temperature Range	-65°C to +150°C
Soldering (reflow)	+260°C
Lead Temperature (soldering, 10s)	+300°C
Pin-to-Pin ESD Ratings	±2.5kV

PACKAGE THERMAL CHARACTERISTICS (Note 1)

SO-EP	
Junction-to-Ambient Thermal Resistance (θ _{JA})	+53°C/W
Junction-to-Case Thermal Resistance (θ _{JC})	+5°C/W

Note 1: Package thermal resistances were obtained using the method described in JEDEC specification JESD51-7, using a four-layer board. For detailed information on package thermal considerations, refer to www.maxim-ic.com/thermal-tutorial.

Stresses beyond those listed under "Absolute Maximum Ratings" may cause permanent damage to the device. These are stress ratings only, and functional operation of the device at these or any other conditions beyond those indicated in the operational sections of the specifications is not implied. Exposure to absolute maximum rating conditions for extended periods may affect device reliability.

ELECTRICAL CHARACTERISTICS

(V_{IN} = +24V, V_{DIM} = V_{IN}, T_A = T_J = -40°C to +125°C, unless otherwise noted. Typical values are at T_A = +25°C.)

PARAMETER	SYMBOL	CONDITIONS	MIN	TYP	MAX	UNITS
Input Voltage Range	V _{IN}		6.5		65	V
Ground Current		No switching		1.5		mA
Supply Current		V _{DIM} < 0.6V, V _{IN} = 12V		350		μA
UNDERVOLTAGE LOCKOUT (UVLO)						
Undervoltage Lockout	UVLO	V _{CS} = V _{IN} - 100mV, V _{IN} rising until V _{LX} < 0.5V _{IN}		6.25	6.5	V
		V _{CS} = V _{IN} - 100mV, V _{IN} falling until V _{LX} > 0.5V _{IN}			6.0	
Undervoltage-Lockout Hysteresis				0.5		V
SENSE COMPARATOR						
Sense Voltage Threshold High	V _{SNSHI}	MAX16832A, V _{IN} - V _{CS} rising from 140mV until V _{LX} > 0.5V _{IN} , V _{DIM} = 5V	197	205	213	mV
		MAX16832C, V _{IN} - V _{CS} rising from 140mV until V _{LX} > 0.5V _{IN} , V _{DIM} = 5V	218	230	236	
Sense Voltage Threshold Low	V _{SNSLO}	MAX16832A, V _{IN} - V _{CS} falling from 260mV until V _{LX} < 0.5V _{IN} , V _{DIM} = 5V	185	190	198	mV
		MAX16832C, V _{IN} - V _{CS} falling from 260mV until V _{LX} < 0.5V _{IN} , V _{DIM} = 5V	166	170	180	
Propagation Delay to Output High	t _{DPDH}	Falling edge of V _{IN} - V _{CS} from 140mV to 260mV to V _{LX} > 0.5V _{IN}		50		ns
Propagation Delay to Output Low	t _{DPDL}	Rising edge of V _{CS} - V _{IN} from 260mV to 140mV to V _{LX} < 0.5V _{IN}		50		ns
CS Input Current	I _{CSIN}	V _{IN} - V _{CS} = 200mV, V _{IN} = V _{CS}			3.5	μA

2MHz, High-Brightness LED Drivers with Integrated MOSFET and High-Side Current Sense

ELECTRICAL CHARACTERISTICS (continued)

($V_{IN} = +24V$, $V_{DIM} = V_{IN}$, $T_A = T_J = -40^{\circ}C$ to $+125^{\circ}C$, unless otherwise noted. Typical values are at $T_A = +25^{\circ}C$.)

PARAMETER	SYMBOL	CONDITIONS	MIN	TYP	MAX	UNITS
INTERNAL MOSFET						
Drain-to-Source Resistance	$R_{DS(on)}$	$V_{IN} = V_{DIM} = 24V$, $V_{CS} = 23.9V$, $I_{LX} = 700mA$		0.45	0.9	Ω
		$V_{IN} = V_{DIM} = 6.0V$, $V_{CS} = 5.9V$, $I_{LX} = 700mA$		1	2	
LX Leakage Current	I_{LX_LEAK}	$V_{DIM} = 0V$, $V_{LX} = 65V$			10	μA
DIM INPUT						
DIM Input-Voltage High	V_{IH}	$V_{IN} - V_{CS} = 100mV$	2.8			V
DIM Input-Voltage Low	V_{IL}	$V_{CS} - V_{IN} = 100mV$			0.6	V
DIM Turn-On Time	t_{DIM_ON}	V_{DIM} rising edge to $V_{LX} < 0.5V_{IN}$		60		ns
DIM Input Leakage High		$V_{DIM} = V_{IN}$		8	15	μA
DIM Input Leakage Low		$V_{DIM} = 0V$	-3	-1.5	0	μA
THERMAL SHUTDOWN						
Thermal-Shutdown Threshold		Temperature rising		+165		$^{\circ}C$
Thermal-Shutdown Threshold Hysteresis				10		$^{\circ}C$
THERMAL FOLDBACK						
Thermal-Foldback Enable Threshold Voltage	V_{TFB_ON}	$V_{DIM} = 5V$	1.9	2.0	2.12	V
Thermal-Foldback Slope	$FBSLOPE$	$V_{DIM} = 5V$		0.75		1/V
TEMP_I Output Bias Current	I_{TEMP_I}	$T_A = +25^{\circ}C$	25	26.5	28	μA

Typical Operating Characteristics

($V_{IN} = V_{DIM} = 48V$, $R_{SENSE} = 0.3\Omega$, $L = 220\mu H$ (connected between IN and CS). Typical values are at $T_A = +25^{\circ}C$, unless otherwise noted.)

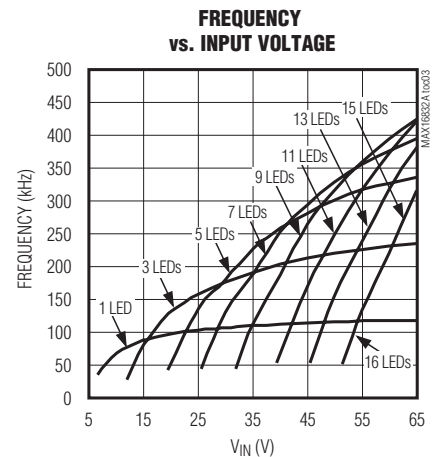
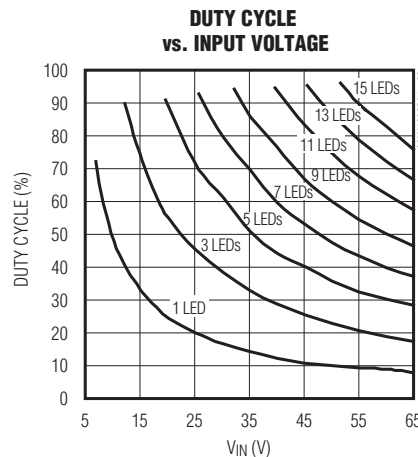
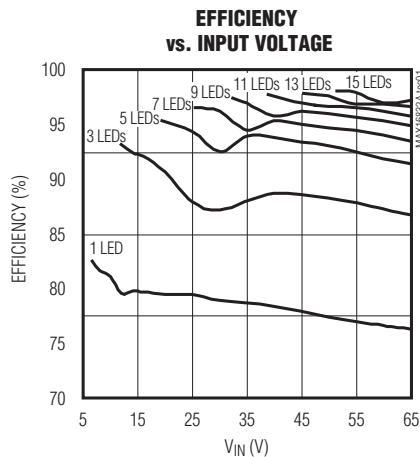

2MHz, High-Brightness LED Drivers with Integrated MOSFET and High-Side Current Sense

Typical Operating Characteristics (continued)

($V_{IN} = V_{DIM} = 48V$, $R_{SENSE} = 0.3\Omega$, $L = 220\mu H$ (connected between IN and CS). Typical values are at $T_A = +25^\circ C$, unless otherwise noted.)

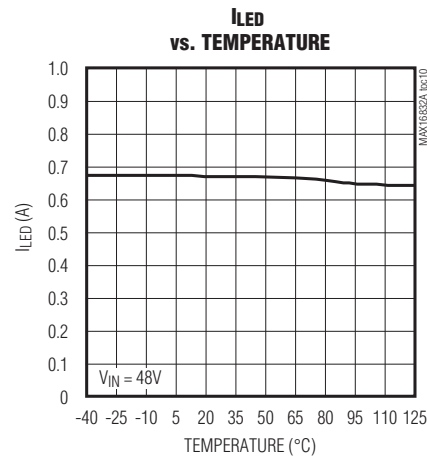
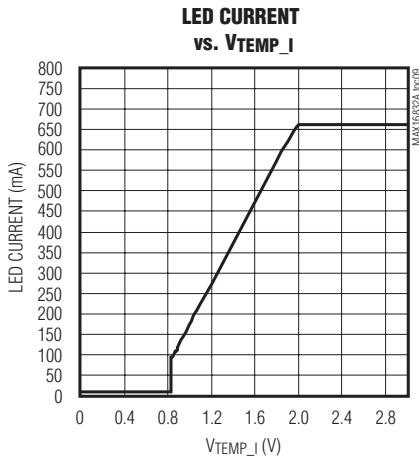
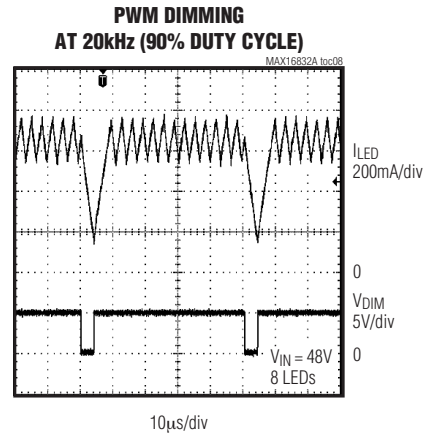
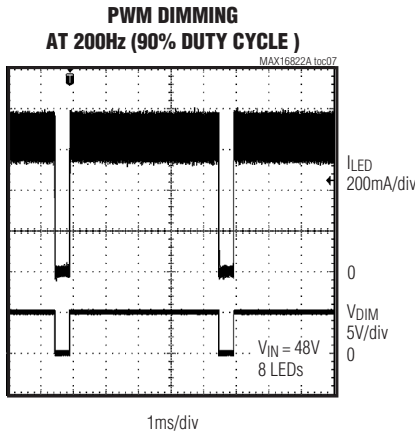
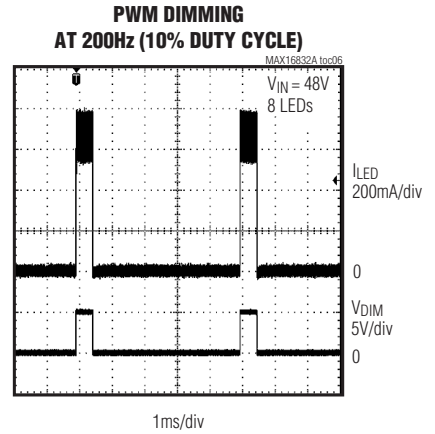
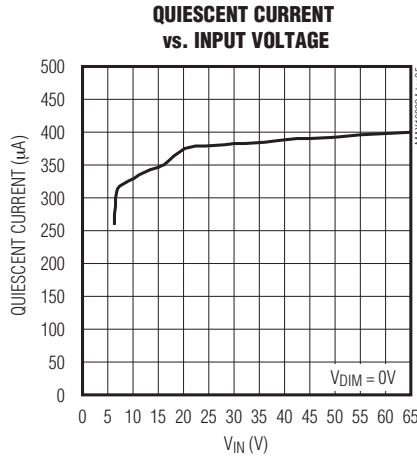
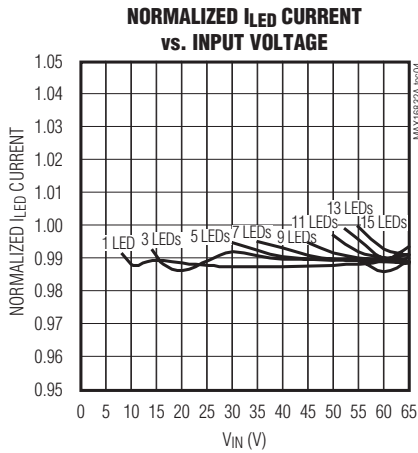

2MHz, High-Brightness LED Drivers with Integrated MOSFET and High-Side Current Sense

Typical Operating Characteristics (continued)

($V_{IN} = V_{DIM} = 48V$, $R_{SENSE} = 0.3\Omega$, $L = 220\mu H$ (connected between IN and CS). Typical values are at $T_A = +25^\circ C$, unless otherwise noted.)

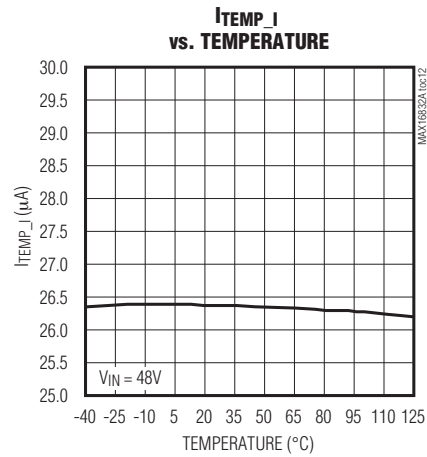
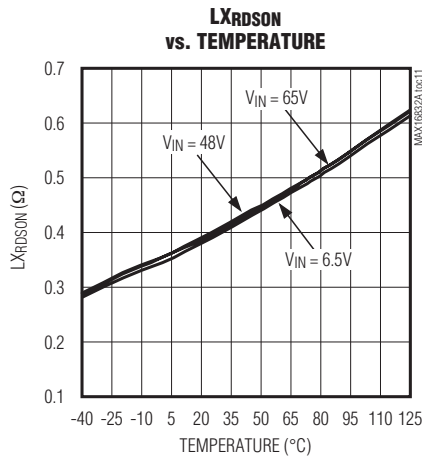

Pin Description

PIN	NAME	FUNCTION
1	CS	Current-Sense Input. Connect a resistor between IN and CS to program the LED current.
2	IN	Positive Supply Voltage Input. Bypass with a 1μF or higher value capacitor to GND.
3	GND	Ground
4	PGND	Power Ground
5, 6	LX	Switching Node
7	DIM	Logic-Level Dimming Input. Drive DIM low to turn off the current regulator. Drive DIM high to enable the current regulator.
8	TEMP_I	Thermal Foldback Control and Linear Dimming Input. Bypass with a 0.01μF capacitor to GND if thermal foldback or analog dimming is used. See the <i>Thermal Foldback</i> section.
—	EP	Exposed Pad. Connect EP to a large-area ground plane for effective power dissipation. Do not use as the IC ground connection.

Detailed Description

The MAX16832A/MAX16832C are step-down, constant-current, HB LED drivers. These devices operate from a +6.5V to +65V input voltage range. The maximum output is 1A, if the part is used at temperatures up to $T_A = +105^\circ C$, or 700mA, if it is used up to $T_A = +125^\circ C$. A high-side current-sense resistor sets the output current

and a dedicated PWM dimming input enables pulsed LED dimming over a wide range of brightness levels.

A high-side current-sensing scheme and an on-board current-setting circuitry minimize the number of external components while delivering LED current with $\pm 3\%$ accuracy, using a 1% sense resistor. See Figure 1 for a functional diagram.

2MHz, High-Brightness LED Drivers with Integrated MOSFET and High-Side Current Sense

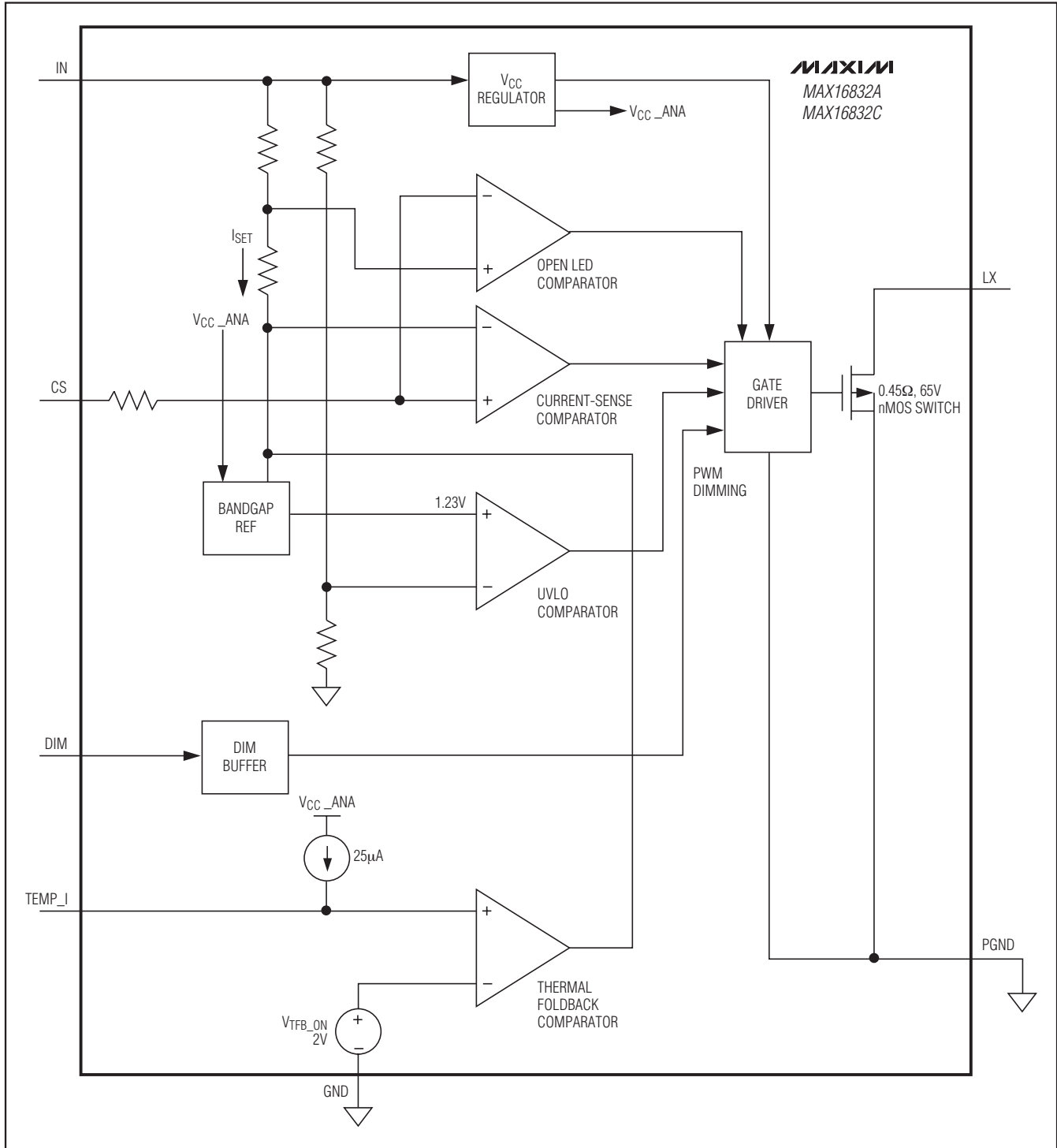

Figure 1. Functional Diagram

2MHz, High-Brightness LED Drivers with Integrated MOSFET and High-Side Current Sense

Undervoltage Lockout (UVLO)

The MAX16832A/MAX16832C include a UVLO with 500mV hysteresis. The internal MOSFET turns off when V_{IN} falls below 5.5V to 6.0V.

DIM Input

LED dimming is achieved by applying a PWM signal at DIM. A logic level below 0.6V at DIM forces the MAX16832A/MAX16832Cs' output low, thus turning off the LED current. To turn the LED current on, the logic level at DIM must be greater than 2.8V.

Thermal Shutdown

The MAX16832A/MAX16832C thermal-shutdown feature turns off the LX driver when the junction temperature exceeds +165°C. The LX driver turns back on when the junction temperature drops 10°C below the shutdown temperature threshold.

Analog Dimming

The MAX16832A/MAX16832C offer an analog-dimming feature that reduces the output current when the voltage at TEMP_I is below the internal 2V threshold voltage. The MAX16832A/MAX16832C achieve analog dimming by either an external DC voltage source connected between TEMP_I and ground or by a voltage on a resistor connected across TEMP_I and ground induced by an internal current source of 25µA. When the voltage at TEMP_I is below the internal 2V threshold limit, the MAX16832A/MAX16832C reduce the LED current. Use the following formula to set the analog dimming current:

$$I_{TF}(A) = I_{LED}(A) \times \left[1 - FB_{SLOPE} \left(\frac{1}{V} \right) \times (V_{TFB_ON} - V_{AD})(V) \right]$$

where $V_{TFB_ON} = 2V$ and $FB_{SLOPE} = 0.75$ are obtained from the *Electrical Characteristics* table and V_{AD} is the voltage at TEMP_I.

Thermal Foldback

The MAX16832A/MAX16832C include a thermal-foldback feature that reduces the output current when the temperature of the LED string exceeds a specified temperature point. These devices enter thermal-foldback mode when the voltage drop on the NTC thermistor, thermally attached to the LEDs and electrically connected between TEMP_I and ground, drops below the internal 2V threshold limit.

Applications Information

Selecting R_{SENSE} to Set LED Current

The LED current is programmed with a current-sense resistor connected between IN and CS. Use the following equation to calculate the value of this resistor:

$$R_{SENSE}(\Omega) = \frac{1}{2} \frac{(V_{SNSHI} + V_{SNSLO})(V)}{I_{LED}(A)}$$

where V_{SNSHI} is the sense voltage threshold high and V_{SNSLO} is the sense voltage threshold low (see the *Electrical Characteristics* table for values).

Current-Regulator Operation

The MAX16832A/MAX16832C regulate the LED current using a comparator with hysteresis (see Figure 2). As the current through the inductor ramps up and the voltage across the sense resistor reaches the upper threshold, the internal MOSFET turns off. The internal MOSFET turns on again when the inductor current ramps down through the freewheeling diode until the voltage across the sense resistor equals the lower threshold. Use the following equation to determine the operating frequency:

$$f_{SW} = \frac{(V_{IN} - nV_{LED}) \times nV_{LED} \times R_{SENSE}}{V_{IN} \times \Delta V \times L}$$

where n is the number of LEDs, V_{LED} is the forward voltage drop of 1 LED, and $\Delta V = (V_{SNSHI} - V_{SNSLO})$.

Inductor Selection

The MAX16832A/MAX16832C operate up to a switching frequency of 2MHz. For space-sensitive applications, the high switching frequency allows the size of the inductor to be reduced. Use the following formula to calculate an approximate inductor value and use the closest standard value:

$$L(\text{approx.}) = \frac{(V_{IN} - nV_{LED}) \times nV_{LED} \times R_{SENSE}}{V_{IN} \times \Delta V \times f_{SW}}$$

For component selection, use the MAX16832A/C Design Tool available at: www.maxim-ic.com/MAX16832-software.

2MHz, High-Brightness LED Drivers with Integrated MOSFET and High-Side Current Sense

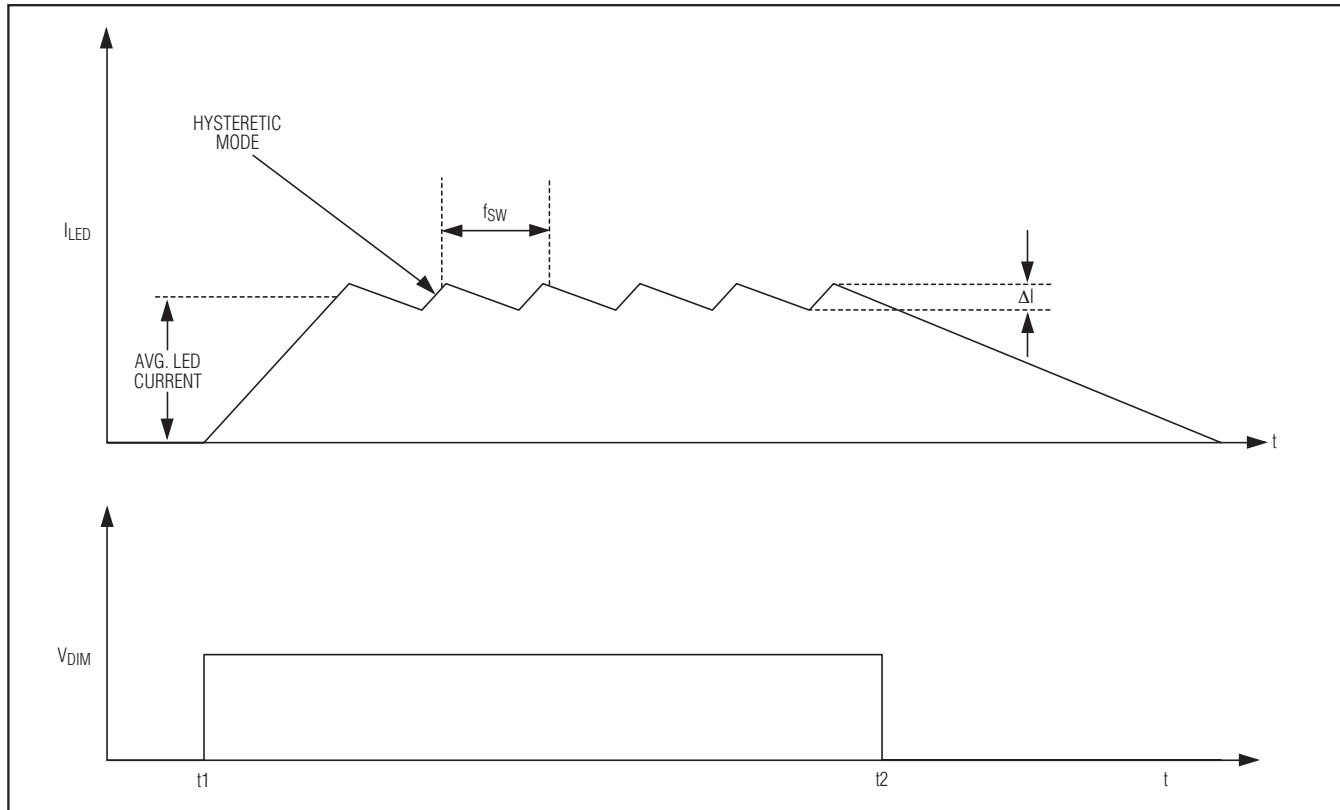

Figure 2. Current-Regulator Operation

Freewheeling-Diode Selection

For stability and best efficiency, a low forward-voltage drop diode with fast reverse-recovery time and low capacitance is recommended. A Schottky diode is a good choice as long as its breakdown voltage is high enough to withstand the maximum operating voltage.

PCB Layout Guidelines

Careful PCB layout is critical to achieve low switching losses and stable operation. In normal operation, there are two power loops. One is formed when the internal MOSFET is on and the high current flows from ground through the input cap, R_{SENSE} , the LED load, the inductor, and the internal MOSFET back to ground. The second loop is formed when the internal MOSFET is off and the high current circulates from the input cap positive terminal through R_{SENSE} , the LED load, the inductor, and the freewheeling diode and back to the input cap positive terminal. Note that the current through R_{SENSE} , the LED load, and the inductor is basically DC with some triangular ripple (low noise). The high-noise, large signal, fast transition switching currents only flow through the freewheeling diode to the input cap positive

terminal, or through the MOSFET to ground and then to the input cap positive terminal. Without a proper PCB layout, these square-wave switching currents can create problems in a hysteretic LED driver.

The current control depends solely on the voltage across R_{SENSE} . Any noise pickup on this node induces erratic switching of the internal MOSFET (the IC will operate at a much higher frequency). To help prevent this, place R_{SENSE} as close as possible to CS and IN and keep the sense traces short. It is especially important to keep the square-wave switching currents in the freewheeling diode away from R_{SENSE} . To minimize interference, place the freewheeling diode on the opposite side of the IC as R_{SENSE} and position the input capacitor near the diode so it can return the high frequency currents to ground. The layout in Figure 3 should be used as a guideline. The dashed line shows the path of the high frequency components that cause disruption in operation. For a good thermal design, the exposed pad on the IC should solder to a large pad with many vias to the backside ground plane.

2MHz, High-Brightness LED Drivers with Integrated MOSFET and High-Side Current Sense

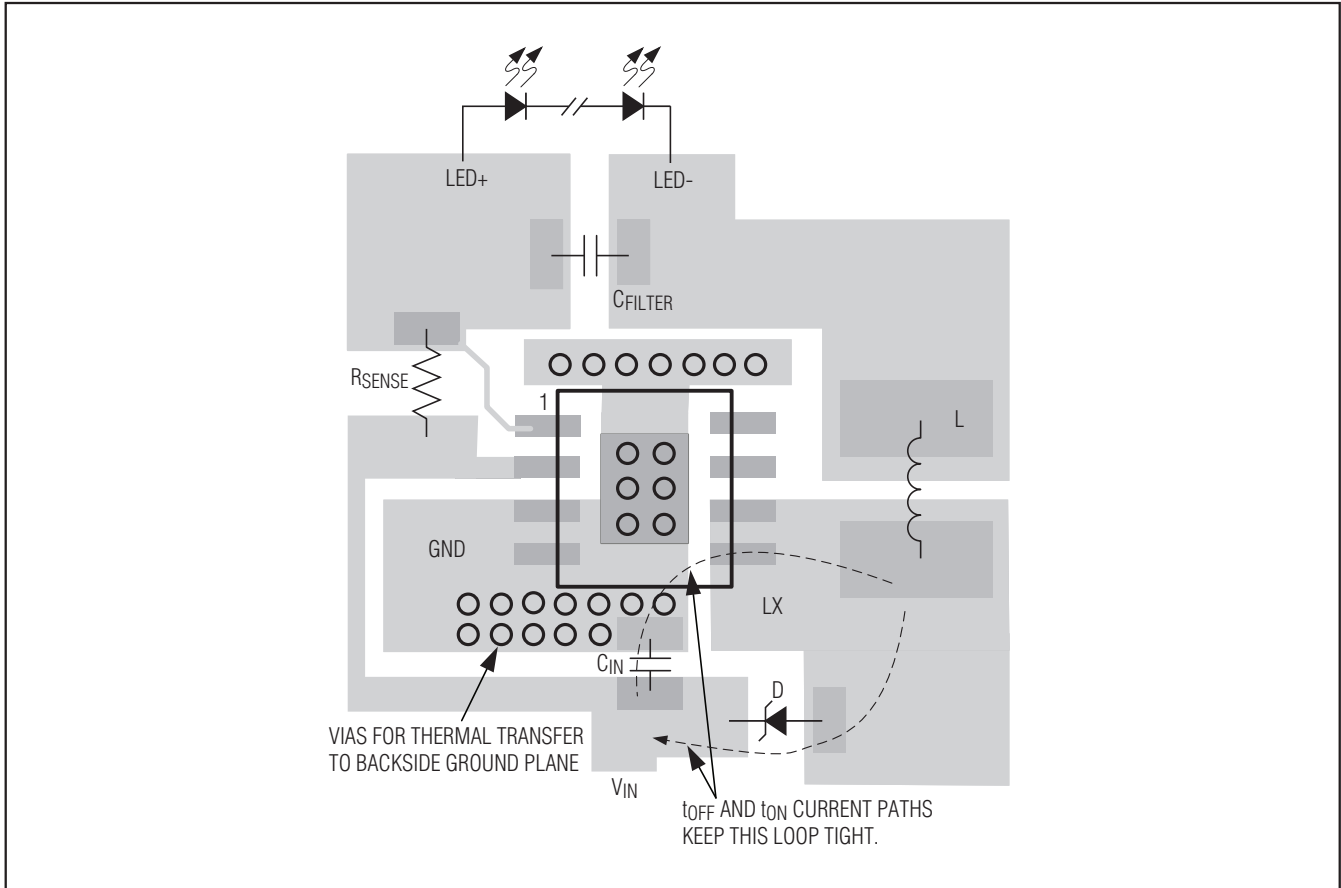
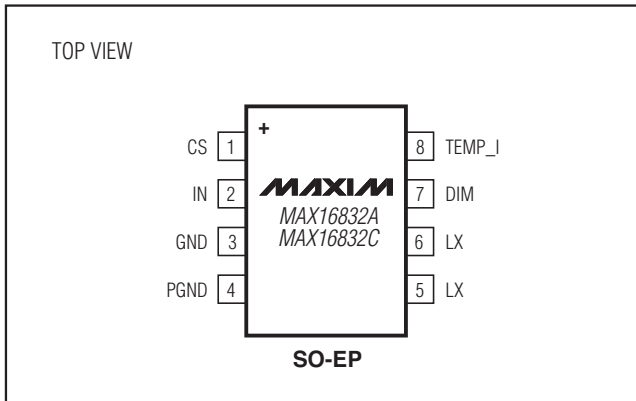

Figure 3. PCB Layout

Pin Configuration



Chip Information

PROCESS: BICMOS

Package Information

For the latest package outline information and land patterns, go to www.maxim-ic.com/packages. Note that a "+", "#", or "-" in the package code indicates RoHS status only. Package drawings may show a different suffix character, but the drawing pertains to the package regardless of RoHS status.

PACKAGE TYPE	PACKAGE CODE	OUTLINE NO.	LAND PATTERN NO.
8 SO-EP	S8E-12	21-0111	90-0150

2MHz, High-Brightness LED Drivers with Integrated MOSFET and High-Side Current Sense

Revision History

REVISION NUMBER	REVISION DATE	DESCRIPTION	PAGES CHANGED
0	5/08	Initial release	—
1	9/08	Introduced the MAX16832C	1
2	5/09	Revised <i>General Description, Features, Absolute Maximum Ratings, and Detailed Description</i>	1, 2, 5
3	2/10	Updated <i>PCB Layout Guidelines</i> and added Figure 3	8, 9
4	8/10	Corrected <i>Functional Diagram</i> and added Soldering (reflow) to <i>Absolute Maximum Ratings</i>	2, 5, 6
5	3/12	Updated Sense Voltage Threshold High and DIM Turn-On Time in <i>Electrical Characteristics</i>	2, 3

Maxim cannot assume responsibility for use of any circuitry other than circuitry entirely embodied in a Maxim product. No circuit patent licenses are implied. Maxim reserves the right to change the circuitry and specifications without notice at any time. The parametric values (min and max limits) shown in the Electrical Characteristics table are guaranteed. Other parametric values quoted in this data sheet are provided for guidance.