



MAX1638VRM Evaluation Kit

General Description

The MAX1638VRM evaluation kit (EV kit) provides a digitally programmable output voltage between 1.3V and 3.5V from a 5V input supply. It delivers up to 14A output current with greater than 90% efficiency. The MAX1638 features 1% output accuracy as well as 1% AC-load regulation. The EV kit operates at a 600kHz switching frequency and has excellent dynamic response to correct for fast output transients.

A separate test-fixture PC board emulates a system motherboard and contains a 22 μ F ceramic capacitor that models the local CPU bypass capacitors. The test fixture also puts the GlitchCatcher MOSFETs on the correct side of the VRM connector, in order to reduce stray inductance.

Ordering Information

PART	TEMP. RANGE	BOARD TYPE
MAX1638VRMEVKIT	0°C to +70°C	Surface Mount

MAX1638VRM Test-Fixture Component List

DESIGNATION	QTY	DESCRIPTION
C1	1	22 μ F, 10V ceramic capacitor TDK C4532X5RA226M or Taiyo Yuden LMK432BJ226K
C2	1	1 μ F ceramic capacitor
U1	1	N- and P-channel MOSFET (SO-8) International Rectifier IRF7105
R1	0	0.5 Ω , 5%, 1/2W resistor (not installed) Dale WSL-2010-R5-J or IRC LR2010-01-R5-J
SW1	1	5-position dip switch
P1	1	40-pin male power connector AMP 146315-1
None	1	MAX1638VRM test-fixture PC board

GlitchCatcher is a registered trademark of Maxim Integrated Products.

Features

- ◆ **4.5V to 5.5V Input Voltage Range**
- ◆ **1.3V to 3.5V Output Voltage Range**
- ◆ **14A Output Current Capability**
- ◆ **1% AC-Load Regulation**
- ◆ **Power-Good Output**
- ◆ **600kHz Switching Frequency**
- ◆ **GlitchCatcher® Provides Excellent Load-Transient Response (MAX1638VRM test fixture)**
- ◆ **24-Pin SSOP Package**
- ◆ **Fully Assembled and Tested**

MAX1638VRM EV Board Component List

DESIGNATION	QTY	DESCRIPTION
C1, C2, C3	3	220 μ F, 10V, low-ESR capacitors Sanyo 10SA220M
C5-C8	4	220 μ F, 4V, low-ESR capacitors Sanyo 4SP220M
C9, C10, C14	3	0.1 μ F ceramic capacitors
C11	1	10 μ F, 10V tantalum capacitor Sprague 595D106X0010A
C12	1	4.7 μ F, 16V tantalum capacitor Sprague 595D475X0016A2T
C13	1	2.2 μ F, 10V ceramic capacitor TDK C3216X7R1C225M or Taiyo Yuden EMK316BJ225ML
CC1	1	1000pF ceramic capacitor
CC2	1	0.056 μ F ceramic capacitor
D1	1	Schottky diode Central Semiconductor CMPSH-3
L1	1	0.47 μ H power inductor Coiltronics UP4-R47 (0.47 μ H) or Panasonic ETQP1F0R7H (0.7 μ H)
N1, N2	2	N-channel MOSFET (D2PAK) Fairchild FDB7030L or International Rectifier IRL3803S
R1, R2	2	0.009 Ω , 1%, 1W resistors Dale WSL-2512-R009-F
R3	1	100 Ω , 5% resistor
R4	1	10 Ω , 5% resistor
R5	1	1k Ω , 5% resistor
R6	1	100k Ω , 5% resistor
U1	1	MAX1638EAG (SSOP-24)
J1	1	40-pin power connector AMP 532956-7
None	1	MAX1638VRM PC board

Evaluates: MAX1638



Maxim Integrated Products 1

For free samples & the latest literature: <http://www.maxim-ic.com>, or phone 1-800-998-8800.
For small orders, phone 408-737-7600 ext. 3468.

MAX1638VRM Evaluation Kit

Component Suppliers

SUPPLIER	PHONE	FAX
AVX	(803) 946-0690	(803) 626-3123
Central Semiconductor	(516) 435-1110	(516) 435-1824
Coilcraft	(847) 639-6400	(847) 639-1469
Coiltronics	(561) 241-7876	(561) 241-9339
Dale-Vishay	(402) 564-3131	(402) 563-6418
Fairchild	(408) 721-2181	(408) 721-1635
International Rectifier	(310) 322-3331	(310) 322-3332
IRC	(512) 992-7900	(512) 992-3377
Kemet	(864) 963-6300	(864) 963-6521
Panasonic	(201) 392-7522	(201) 392-4441
Sanyo	(619) 661-6835	(619) 661-1055
Sprague	(603) 224-1961	(603) 224-1430
Sumida	(847) 956-0666	(847) 956-0702
Taiyo Yuden	(408) 573-4150	(408) 573-4159
TDK	(847) 390-4373	(847) 390-4428
Vishay/Vitramon	(203) 268-6261	(203) 452-5670

Note: Please indicate that you are using the MAX1638 when contacting these component suppliers.

Quick Start

The MAX1638VRM EV kit is fully assembled and tested. Follow these steps to verify board operation. **Do not turn on the power supply until all connections are completed.**

- 1) Connect a +5V supply voltage to the VIN pad. Connect ground to the GND pad located on the MAX1638VRM test board.
- 2) Connect a voltmeter and load, if any, to the VOUT pad.
- 3) Turn on the power supply to the board.
- 4) Set switch SW1 per Table 1 to get the desired output voltage.

Detailed Description

Jumper Selection

The 3-pin jumper JU1 selects the AC loop gain. Table 2 lists the selectable jumper options. JU1 allows the user to trade off gain response to AC-load regulation and transient response. AC-load regulation can be set to 0.5%, 1%, and 2%. The default value is 1%.

Table 1. MAX1638 Output Voltage Adjustment Settings (abbreviated)

D4	D3	D2	D1	D0	OUTPUT VOLTAGE (V)
0	0	0	0	0	2.050
0	0	0	0	1	2.000
—	—	—	—	—	Decreases in 50mV increments
0	1	1	1	1	1.3
1	0	0	0	0	3.5
1	0	0	0	1	3.4
—	—	—	—	—	Decreases in 100mV increments
1	1	1	1	0	2.1
1	1	1	1	1	Off

Table 2. Jumper JU1 Functions

SHUNT LOCATION	LG PIN	AC LOOP REGULATION (%)
2 & 3	Connected to GND	0.5
Not installed	Floating	1
1 & 2	Connected to VCC	2

Table 3. Jumper JU2 Functions

SHUNT LOCATION	FREQ PIN	SWITCHING FREQUENCY (kHz)
1 & 4	Connected to GND	300
1 & 2	Connected to REF	600
1 & 3	Connected to VCC	1000

The 4-pin jumper JU2 selects the switching frequency. Table 3 lists the selectable jumper options. The EV kit's components are selected for 600kHz operation. If 300kHz or 1MHz operation is selected, component values might need to be changed and the PC board trace between pins 1 and 2 of JU2 must be cut (refer to the *Design Procedure* section in the MAX1638 data sheet).

MAX1638VRM Evaluation Kit

GlitchCatcher Current-Boost Driver
 Drivers for an optional current-boost circuit (GlitchCatcher) are included in the MAX1638. The current-boost circuit is intended to improve transient response to fast-load step changes by bypassing the inductor's lowpass filter operation. When the output voltage drops out of regulation by more than $\pm 2\%$, the

P-channel or N-channel switches turn on and force the output back into regulation. The GlitchCatcher circuit is located on the solder side of the MAX1638VRM test fixture. For more information, refer to the section *Choosing the GlitchCatcher* MOSFETs in the MAX1638 data sheet.

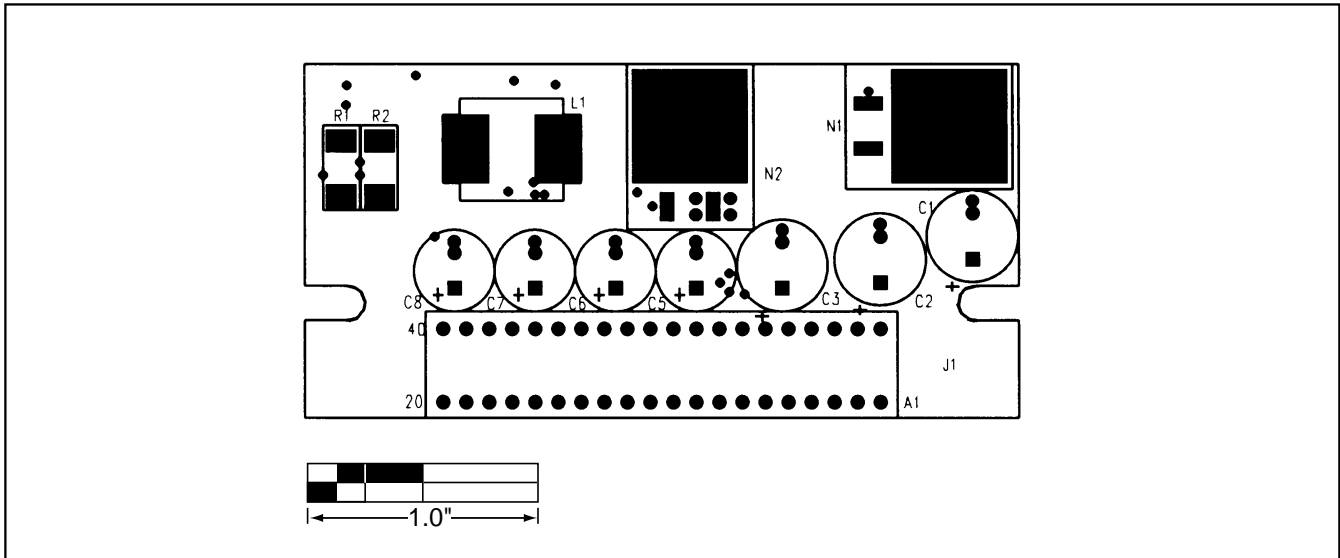

Figure 2. MAX1638VRM EV Kit Component Placement Guide—Component Side

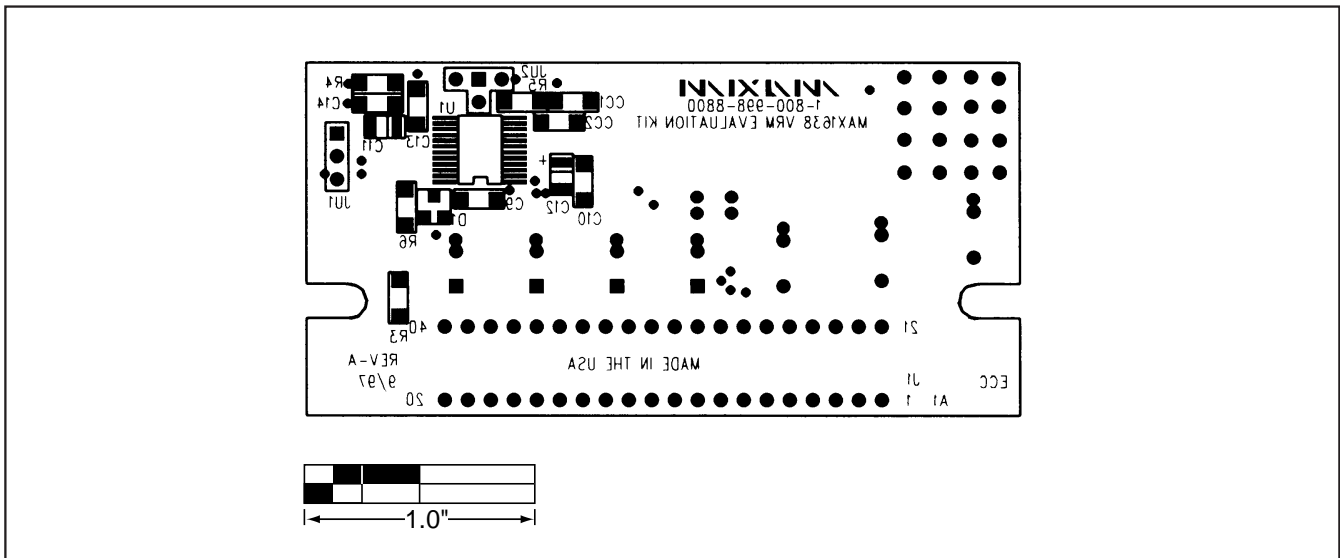

Figure 3. MAX1638VRM EV Kit Component Placement Guide—Solder Side

MAX1638VRM Evaluation Kit

Evaluates: MAX1638

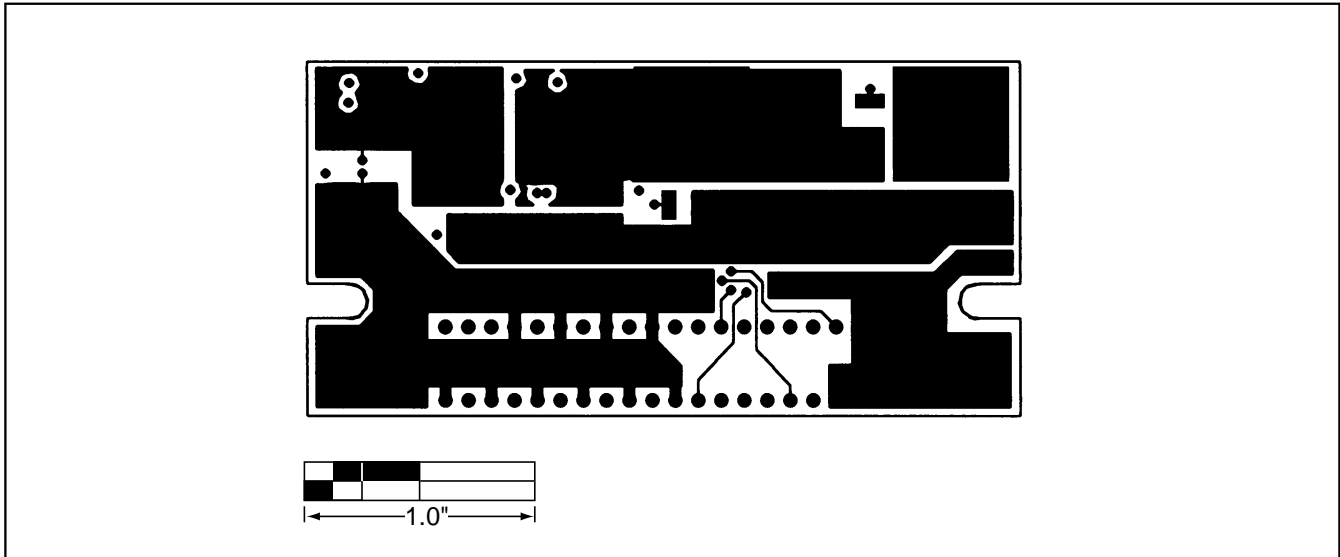

Figure 4. MAX1638VRM EV Kit PC Board Layout—Component Side

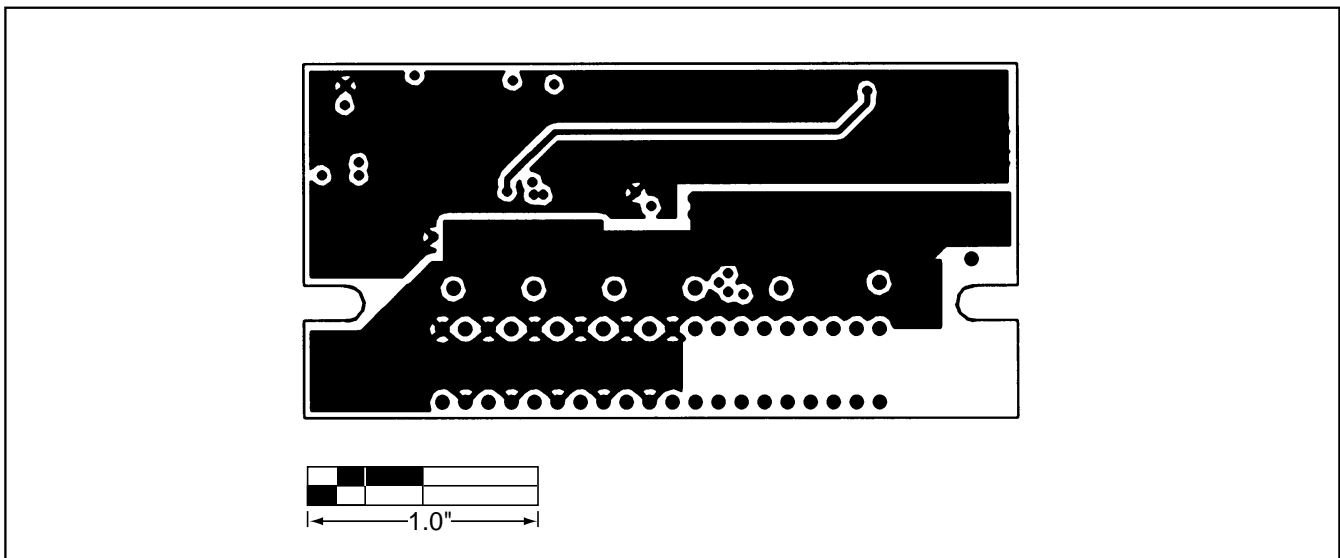

Figure 5. MAX1638VRM EV Kit PC Board Layout—Internal Signal Plane (Layer 2)

MAX1638VRM Evaluation Kit

Evaluates: MAX1638

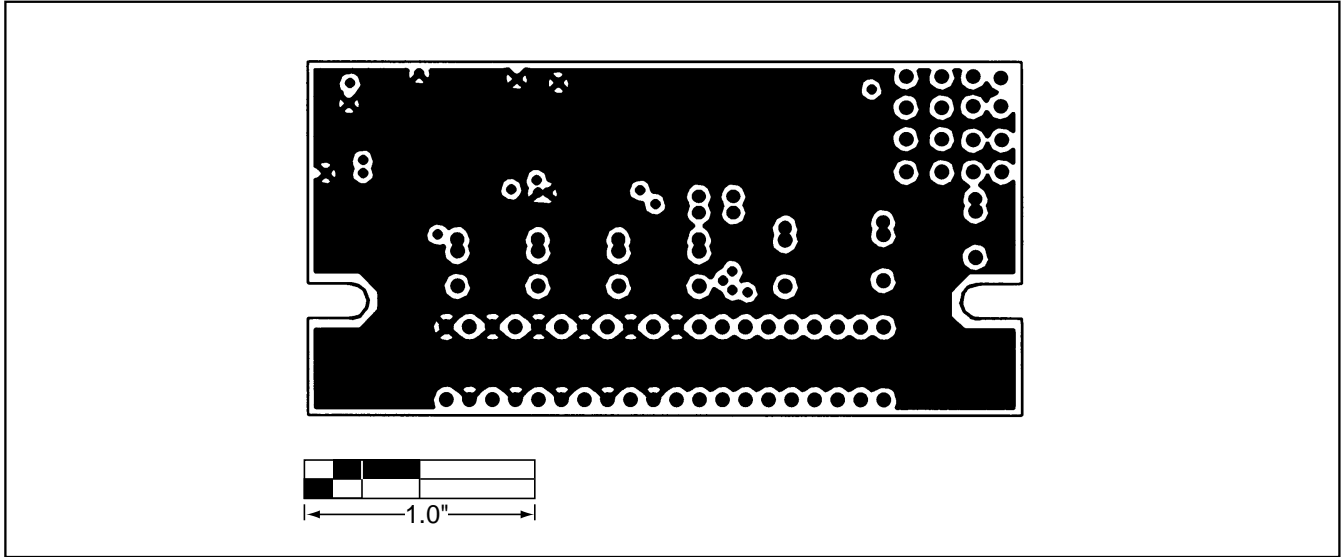

Figure 6. MAX1638VRM EV Kit PC Board Layout—Internal GND Plane (Layer 3)

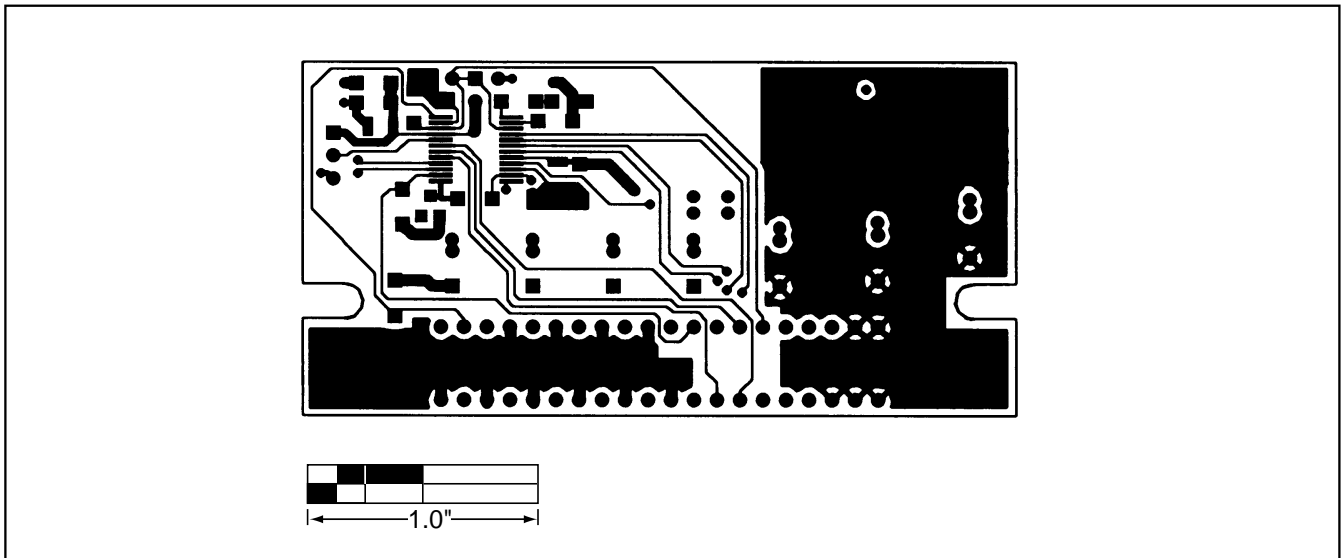

Figure 7. MAX1638VRM EV Kit PC Board Layout—Solder Side

MAX1638VRM Evaluation Kit

Evaluates: MAX1638

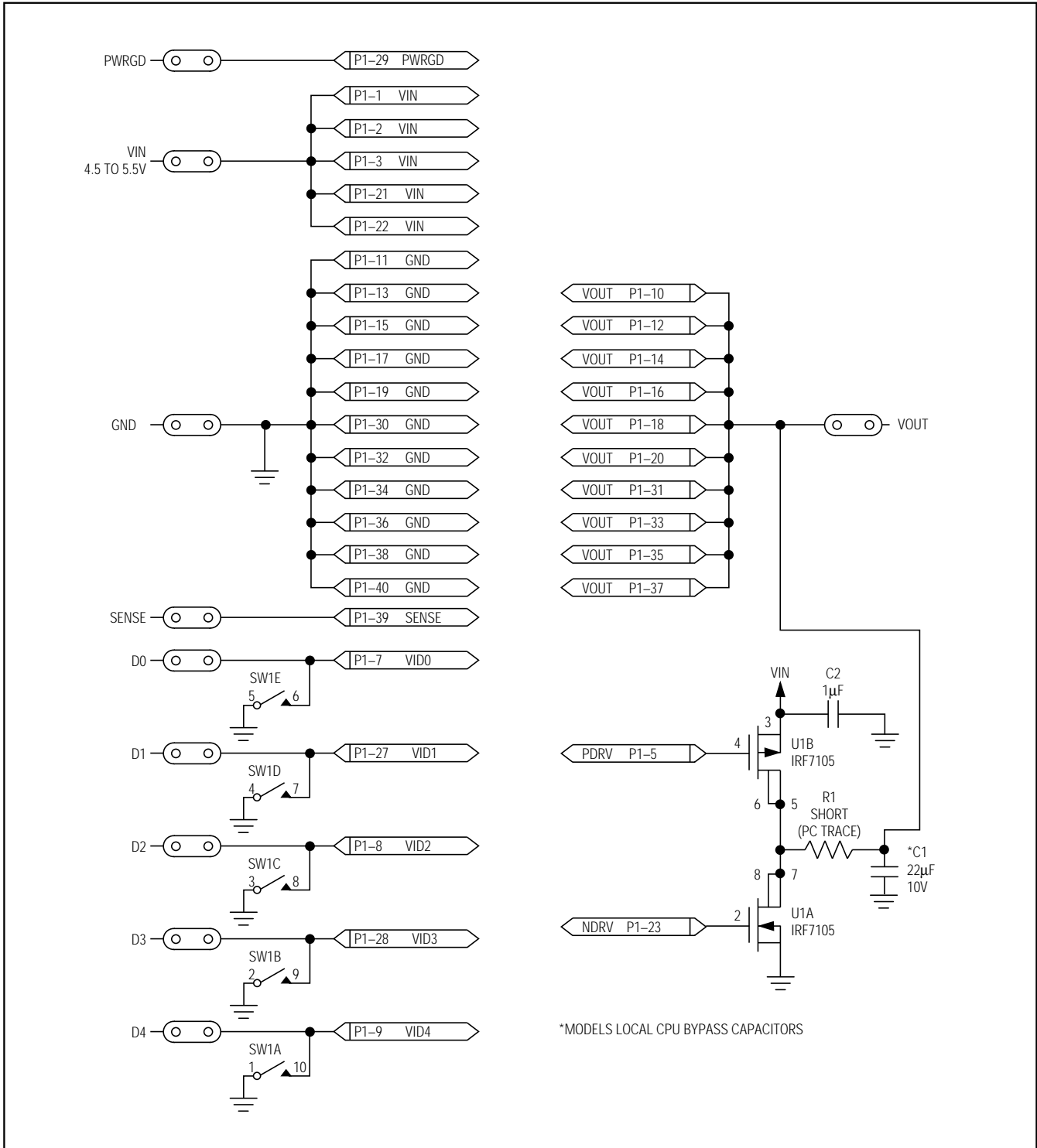

Figure 8. MAX1638VRM EV Kit Test Fixture

MAX1638VRM Evaluation Kit

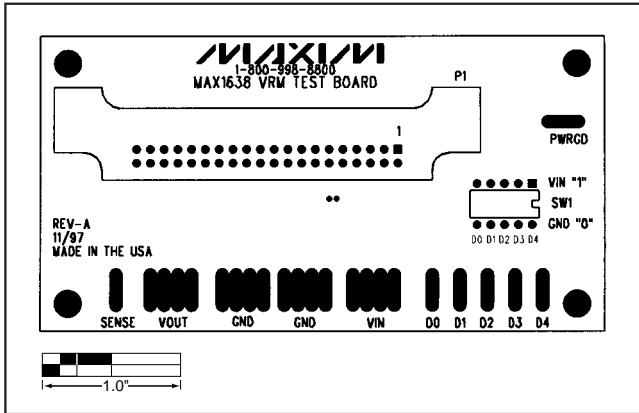

Figure 9. MAX1638VRM EV Kit Test Fixture Component Placement Guide—Component Side

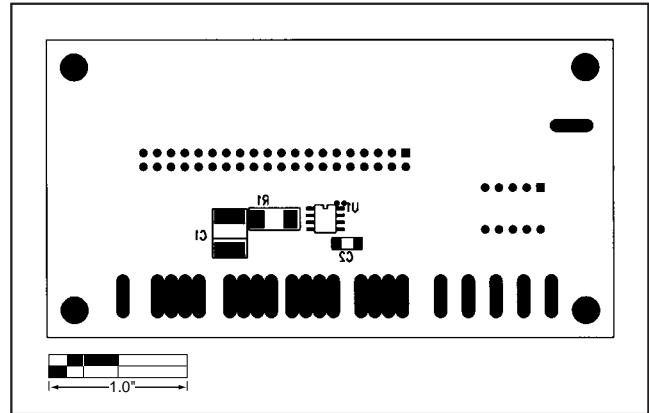

Figure 10. MAX1638VRM EV Kit Test-Fixture Component Placement Guide—Solder Side

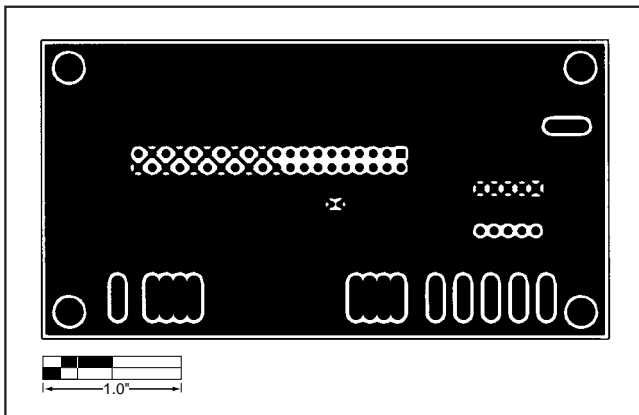

Figure 11. MAX1638VRM EV Kit Test-Fixture PC Board Layout—Component Side

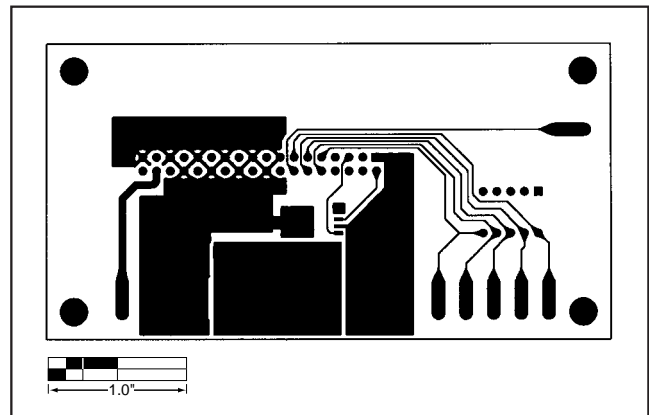

Figure 12. MAX1638VRM EV Kit Test-Fixture PC Board Layout—Solder Side

Maxim cannot assume responsibility for use of any circuitry other than circuitry entirely embodied in a Maxim product. No circuit patent licenses are implied. Maxim reserves the right to change the circuitry and specifications without notice at any time.

8 _____ Maxim Integrated Products, 120 San Gabriel Drive, Sunnyvale, CA 94086 (408) 737-7600