



# MAX1549 Evaluation Kit

**Evaluates: MAX1549**

## General Description

The MAX1549 evaluation kit (EV kit) demonstrates the MAX1549's standard application circuit. This DC-DC converter steps down high-voltage batteries and/or AC adapters, generating precision low-voltage chipset and RAM power supplies for notebook computers.

The MAX1549 EV kit provides a dynamically adjustable 0.7V to 1.5V output voltage range (OUT1), and a fixed 2.5V output voltage (OUT2) from a 5V to 20V battery input range. It delivers up to a 6A output current for OUT1, and up to a 4A output current for OUT2, with greater than 90% efficiency. The EV kit operates at 300kHz switching frequency and has superior line- and load-transient response.

This EV kit is a fully assembled and tested circuit board. It is capable of evaluating other dynamically adjustable output voltages in the 0.5V to 2.0V range by changing R10–R14. Other fixed output voltages in the 0.5V to 2.7V range can be evaluated by changing R20 and R21.

## Features

- ◆ 5V to 20V Input Voltage Range
- ◆ Four Digitally Selectable Operating Voltages (OUT1)
- ◆ Dynamically Selectable Output Voltages 0.7V/1.0V/1.3V/1.5V (OUT1, Adjustable from 0.5V to 2.0V)
- ◆ Fixed 2.5V Output Voltage (OUT2, Adjustable from 0.5V to 2.7V)
- ◆ 6A Output Current (OUT1)
- ◆ 4A Output Current (OUT2)
- ◆ 300kHz Switching Frequency
- ◆ Independent Power-Good Outputs
- ◆ Low-Profile Components
- ◆ Fully Assembled and Tested

## Ordering Information

PART	TEMP RANGE	IC PACKAGE
MAX1549EVKIT	0°C to +70°C	40 Thin QFN (6mm x 6mm)

## Component List

DESIGNATION	QTY	DESCRIPTION
C1, C19	0	Not installed (E-case)
C2	1	470 $\mu$ F, 2.5V, 6m $\Omega$ low-ESR polymer capacitor (E-case) Sanyo 2R5TPD470M6
C3	1	220 $\mu$ F, 4V, 15m $\Omega$ low-ESR capacitor (D-case) Sanyo 4TPE220MF
C4, C5	2	10 $\mu$ F $\pm$ 20%, 25V X5R ceramic capacitors (1812) Taiyo Yuden TMK432BJ106KM or TDK C4532X5R1E106M
C6, C7	0	Not installed (1812)
C8, C9	2	0.1 $\mu$ F $\pm$ 10%, 50V X7R ceramic capacitors (0603) Murata GRM188R71H104K or equivalent
C10, C11, C20–C26	0	Not installed (0603)

DESIGNATION	QTY	DESCRIPTION
C12	1	2.2 $\mu$ F, 10V X5R ceramic capacitor (0612) TDK C1632X5R1A225KTB09N
C13, C16	2	470pF $\pm$ 10%, 50V X7R ceramic capacitors (0603) Murata GRM188R71H471K or equivalent
C14	1	0.22 $\mu$ F, 16V X5R ceramic capacitor (0805) Taiyo Yuden EMK212BJ224KG
C15	1	1 $\mu$ F $\pm$ 20%, 10V X5R ceramic capacitor (0805) Taiyo Yuden LMK212BJ105KG or TDK C2012X7R1C105MKT
C17, C18	2	100pF $\pm$ 5%, 50V C0G ceramic capacitors (0603) Murata GRM1885C1H101J or equivalent

# MAX1549 Evaluation Kit

Evaluates: MAX1549

## Component List (continued)

DESIGNATION	QTY	DESCRIPTION
C27, C28	2	10 $\mu$ F $\pm$ 20%, 6.3V X5R ceramic capacitors (0805) TDK C2012X5R0J106M or Taiyo Yuden AMK212BJ106MG
D1, D2	2	1A, 30V Schottky diodes Nihon EP10QY03 or Toshiba CRS02
D3	1	100mA, 30V dual Schottky diode (SOT23) Central Semiconductor CMPSH-3A
JU1, JU2, JU6	3	3-pin headers
JU3	0	Not installed, 4-pin header
JU4, JU5	2	2-pin headers
JU1 (1,2) JU2 (1,2) JU6 (1,2)	4	Shunts
L1	1	1.5 $\mu$ H, 7A power inductor Sumida CDRH105R-1R5
L2	1	4.7 $\mu$ H, 5.7A power inductor Sumida CDRH124-4R7
N1, N3	2	N-channel MOSFETs (8-pin SO) Fairchild FDS6612A
N2, N4	2	N-channel MOSFETs (8-pin SO) Fairchild FDS6670A

DESIGNATION	QTY	DESCRIPTION
R1	1	0.012 $\Omega$ $\pm$ 1%, 0.5W resistor (2010) IRC LR2010-01-R012-F or Dale WSL-2010-R012F
R2	1	0.015 $\Omega$ $\pm$ 1%, 0.5W resistor (2010) IRC LR2010-01-R015-F or Dale WSL-2010-R015F
R3–R6, R22, R23	0	Not installed (short PC trace) (0603)
R7, R8, R27, R28	4	100k $\Omega$ $\pm$ 5% resistors (0603)
R9	1	10 $\Omega$ $\pm$ 5% resistor (0805)
R10, R15–R18	5	100k $\Omega$ $\pm$ 1% resistors (0603)
R11	1	301k $\Omega$ $\pm$ 1% resistor (0603)
R12	1	487k $\Omega$ $\pm$ 1% resistor (0603)
R13	1	150k $\Omega$ $\pm$ 1% resistor (0603)
R14	1	66.5k $\Omega$ $\pm$ 1% resistor (0603)
R19, R20, R24, R25, R26, R29, R32	0	Not installed (0603)
R21	1	0 $\Omega$ $\pm$ 1% resistor (0603)
U1	1	MAX1549ETL (40-pin thin QFN 6mm x 6mm)
—	4	Rubber bumpers
—	1	MAX1549 PC board

## Component Suppliers

SUPPLIER	PHONE	FAX	WEBSITE
Central Semiconductor	516-435-1110	516-435-1824	www.centalsemi.com
Dale-Vishay	402-564-3131	402-563-6296	www.vishay.com
Fairchild	408-721-2181	408-721-1635	www.fairchildsemi.com
IRC	361-992-7900	361-992-3377	www.irctt.com
Murata	770-436-1300	770-436-3636	www.murata.com
Nihon	847-843-7500	847-843-2798	www.niec.co.jp
Sanyo	619-661-6835	619-661-1055	www.sanyovideo.com
Sumida	708-956-0666	708-956-0702	www.sumida.com
Taiyo Yuden	800-348-2496	847-925-0899	www.t-yuden.com
TDK	847-390-4373	847-390-4428	www.component.tdk.com

**Note:** Indicate that you are using the MAX1549 when contacting these component suppliers.

### Quick Start

#### Equipment Needed

- 5V to 20V power supply, battery, or notebook AC adapter
- DC bias power supply, 5V at 100mA
- Dummy loads capable of sinking 6A
- Digital multimeters (DMMs)
- 100MHz dual-trace oscilloscope

# MAX1549 Evaluation Kit

Evaluates: MAX1549

## Procedure

- 1) Ensure that the circuit is connected correctly to the supplies and dummy loads prior to applying any power.
- 2) Verify that the shunts are installed across pins 1 and 2 of jumper JU1 (ON1 high), pins 1 and 2 of jumper JU2 (ON2 high), and pins 1 and 2 of JU6 (SKIP high, forced PWM).
- 3) Turn on battery power prior to +5V bias power; otherwise, the output UVLO timer times out and the FAULT latch is set, disabling the regulator outputs until +5V power is cycled or ON1/ON2 is toggled.
- 4) Verify that the output voltages are  $V_{OUT1} = 1.5V$ ,  $V_{OUT2} = 2.5V$ .

## Detailed Description

### Jumper Settings

**Table 1. Jumper JU1 Functions (Output Voltage OUT1 Control)**

JU1	ON1 PIN	OUT1
1 and 2 (Default)	Connected to VCC.	OUT1 enabled, $V_{OUT1} = 1.5V$ . OUT1 depends on gate inputs G0 and G1. See Table 4.
2 and 3	Connected to GND.	OUT1 shutdown mode
Not installed	ON1 must be driven by an external signal connected to ON1 pad.	OUT1 operation depends on the external ON1 signal levels.

**Table 2. Jumper JU2 Functions (Output Voltage OUT2 Control)**

JU2	ON2 PIN	OUT2
1 and 2 (Default)	Connected to VCC.	OUT2 enabled, $V_{OUT2} = 2.5V$
2 and 3	Connected to GND.	OUT2 shutdown mode
Not Installed	ON2 must be driven by an external signal connected to ON2 pad.	OUT2 operation depends on the external ON2 signal levels.

**Table 3. Jumpers JU3 Functions (Switching-Frequency Selection)**

JU3	TON PIN	FREQUENCY (kHz)
1 and 2	Connected to VCC	400
1 and 3	Connected to REF	200
1 and 4	Connected to GND	100
Not installed (Default)	Floating	300 (As Shipped)

**Note:** Do not change the operating frequency without first recalculating component values. The frequency has a significant effect on preferred inductor value, peak current-limit level, MOSFET heating, PFM/PWM switchover point, output noise, efficiency, and other critical parameters.

**Table 4. Jumpers JU4 and JU5 Functions (Gate Inputs G0 and G1)**

JU4	JU5	OUT1
Not installed G0 = GND	Not installed G1 = GND	1.50V (Default)
Not installed G0 = GND	Installed G1 = VCC	0.70V
Installed G0 = VCC	Not installed G1 = GND	1.00V
Installed G0 = VCC	Installed G1 = VCC	1.30V

**Table 5. Jumper JU6 Functions (Low-Noise Mode)**

JU6	SKIP PIN	OPERATIONAL MODE
1 and 2 (Default)	Connected to VCC.	Low-noise mode, OUT1 and OUT2 are in forced PWM mode.
2 and 3	Connected to GND.	OUT1 and OUT2 are in pulse-skipping mode.

## MAX1549 Evaluation Kit

### **Evaluating Other Dynamic Output Voltages (OUT1)**

The EV kit output is preset to 0.7V/1.0V/1.3V/1.5V (OUT1). G0 (JU4) and G1 (JU5) gate inputs select the OUT1 voltage (see Table 4). However, OUT1 can also be adjusted between 0.5V and 2.0V by selecting R10–R14 values. Refer to the MAX1549 data sheet *Output Voltage* section for more information.

### **Evaluating Other Fixed Output Voltages (OUT2)**

The MAX1549 provides a fixed 2.5V output (OUT2) when FB2 is connected to GND (R20 = open, R21 = 0, R19 = open) or a fixed 1.8V output when FB2 is con-

nected to VCC (R20 = open, R21 = open, R19 = 0). OUT2 can also be adjusted from 0.5V to 2.7V by using a resistive voltage-divider formed by R20 and R21 (R19 = open). The MAX1549 regulates FB2 to a fixed reference voltage (0.5V).

The adjusted output voltage is:

$$V_{OUT2} = V_{FB2}(1 + R20/R21) \text{ where } V_{FB2} = 0.5V$$

A 330pF to 1000pF feed-forward bypass capacitor (C26) reduces duty-cycle jitter and feedback noise.

Refer to the MAX1549 data sheet for selection of output-capacitor and inductor values for different output voltages.

# MAX1549 Evaluation Kit

Evaluates: MAX1549

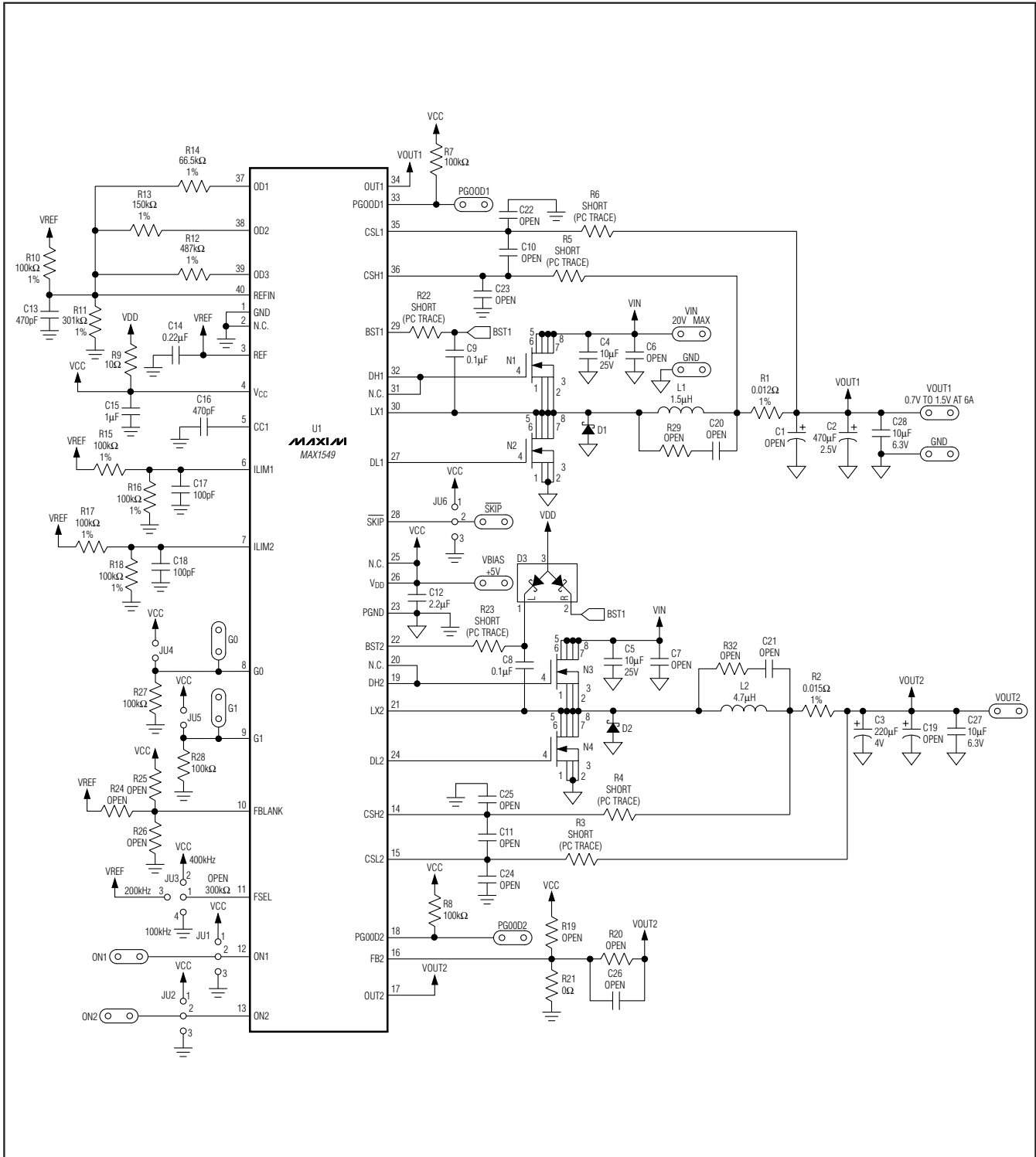

Figure 1. MAX1549 EV Kit Schematic

# MAX1549 Evaluation Kit

Evaluates: MAX1549

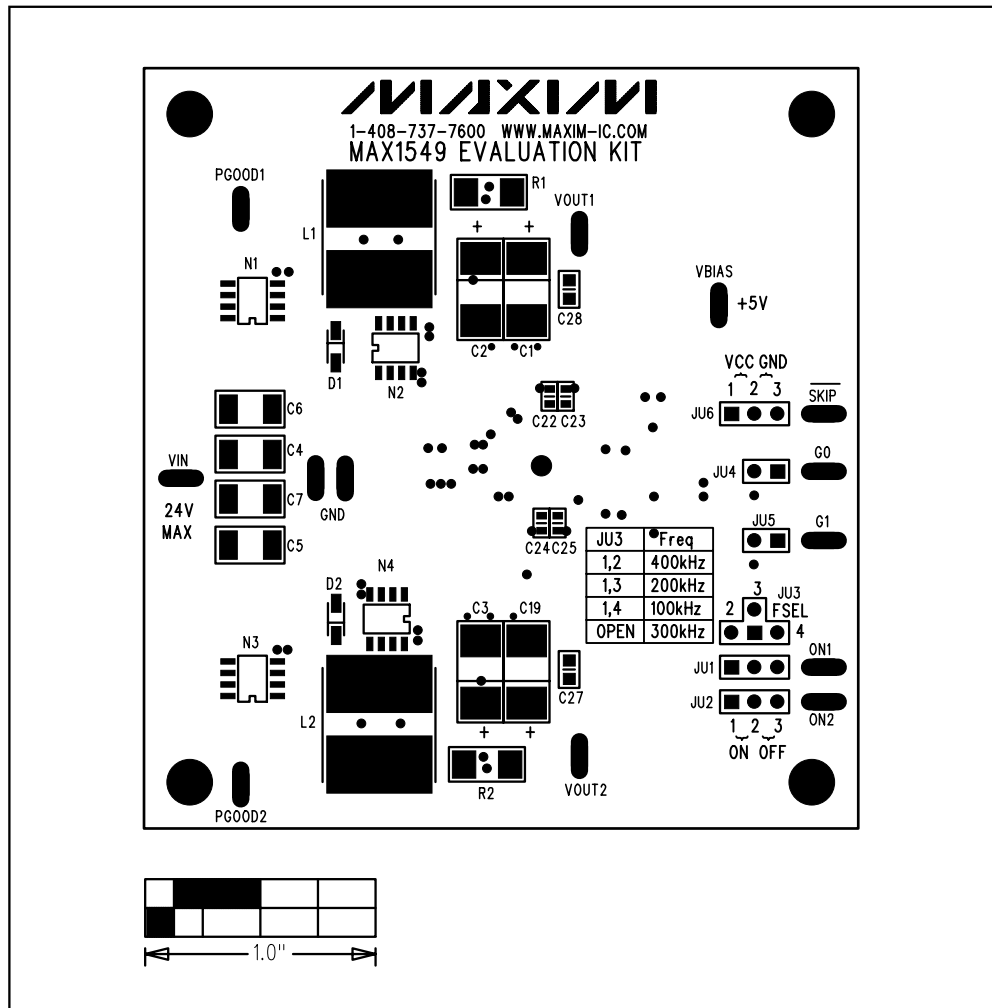

Figure 2. MAX1549 EV Kit Component Placement Guide—Component Side

# MAX1549 Evaluation Kit

Evaluates: MAX1549

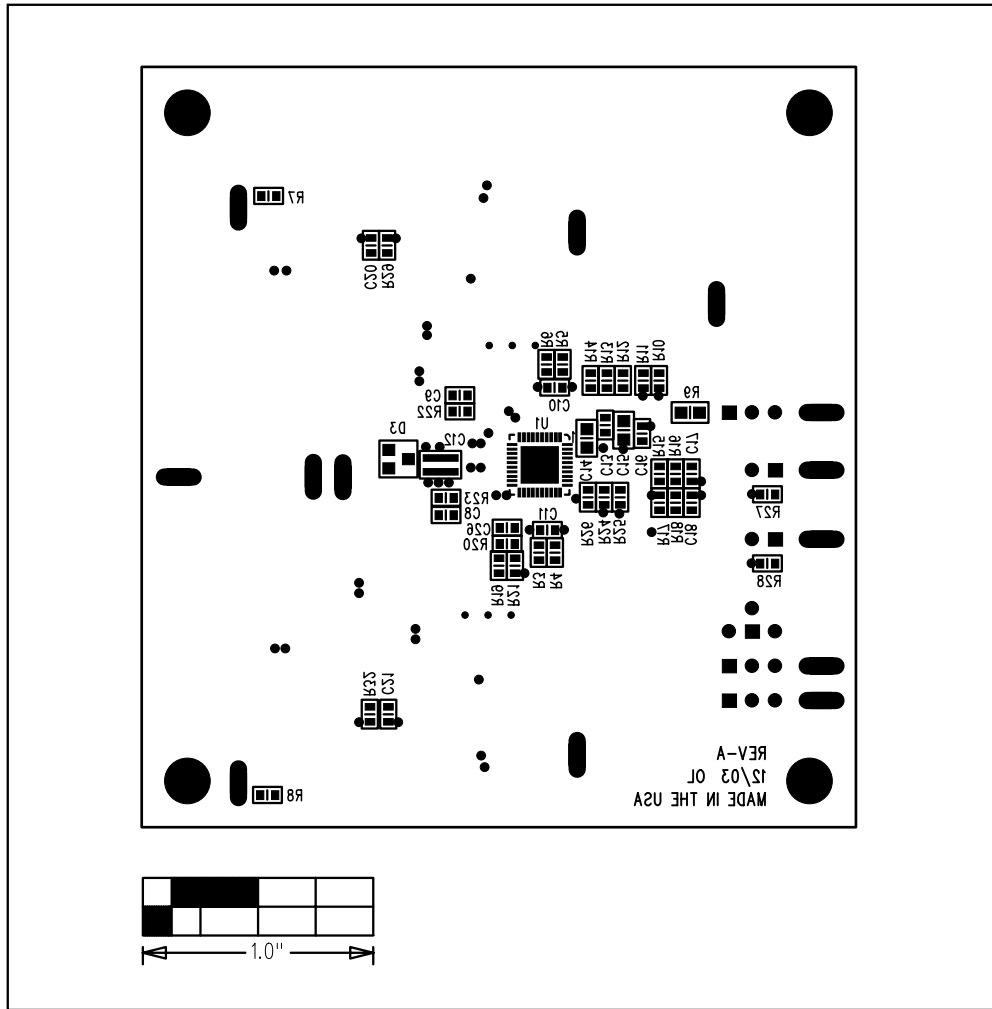

Figure 3. MAX1549 EV Kit Component Placement Guide—Solder Side

# MAX1549 Evaluation Kit

Evaluates: MAX1549

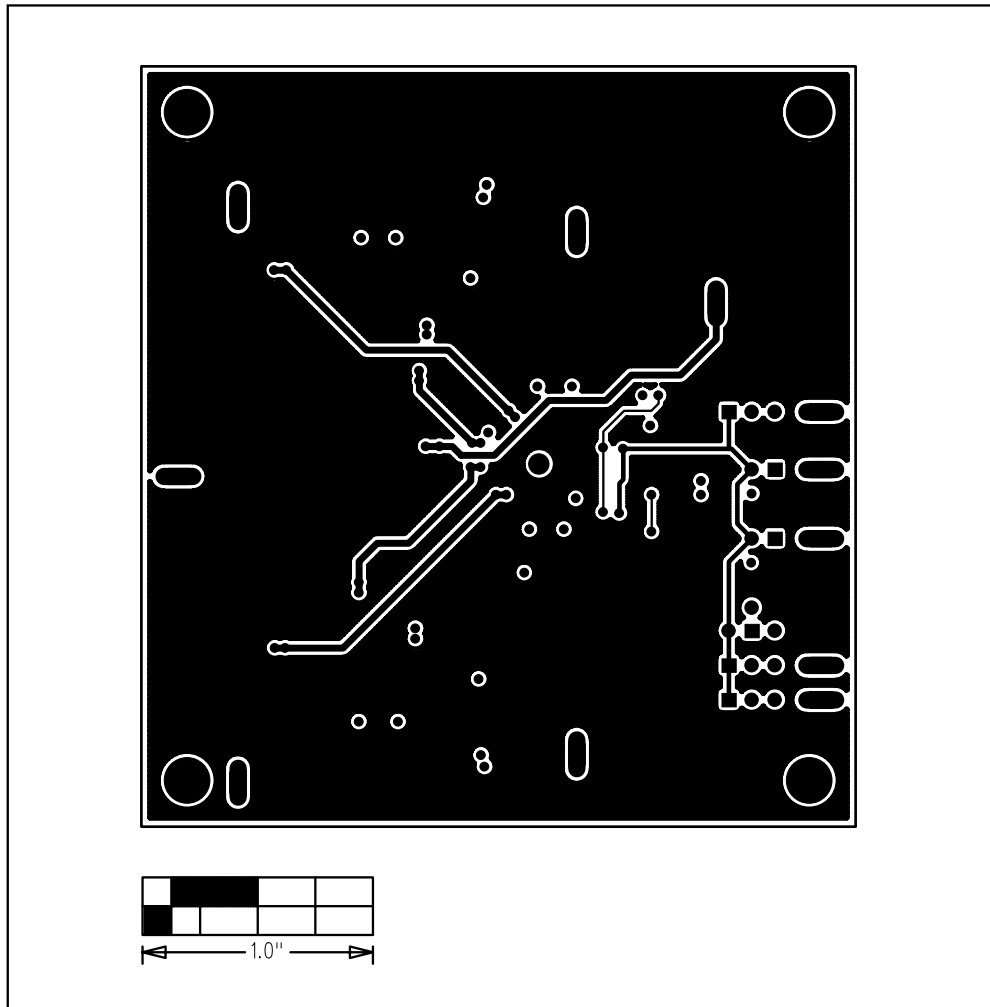

Figure 4. MAX1549 EV Kit PC Board Layout—Ground/Signal Layer 2

# MAX1549 Evaluation Kit

Evaluates: MAX1549

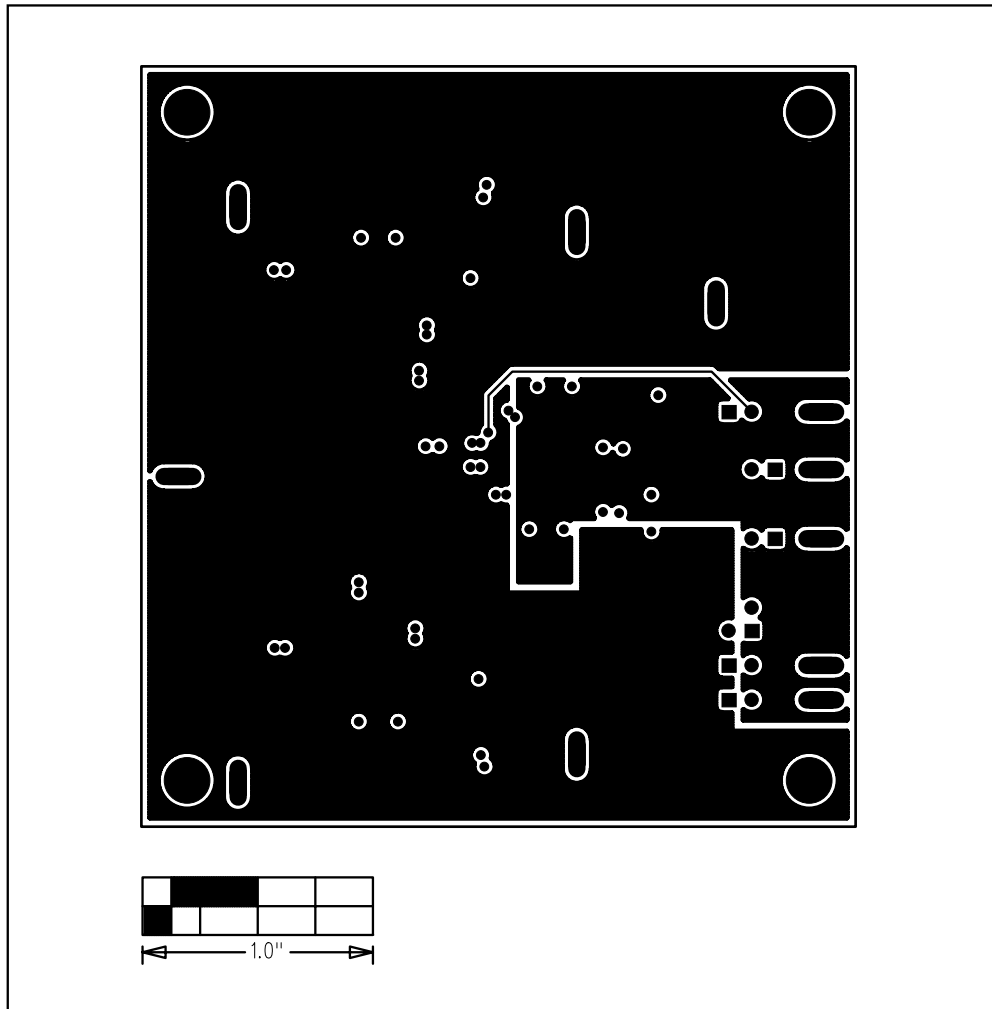

Figure 5. MAX1549 EV Kit PC Board Layout—Ground Plane Layer 3

# MAX1549 Evaluation Kit

Evaluates: MAX1549

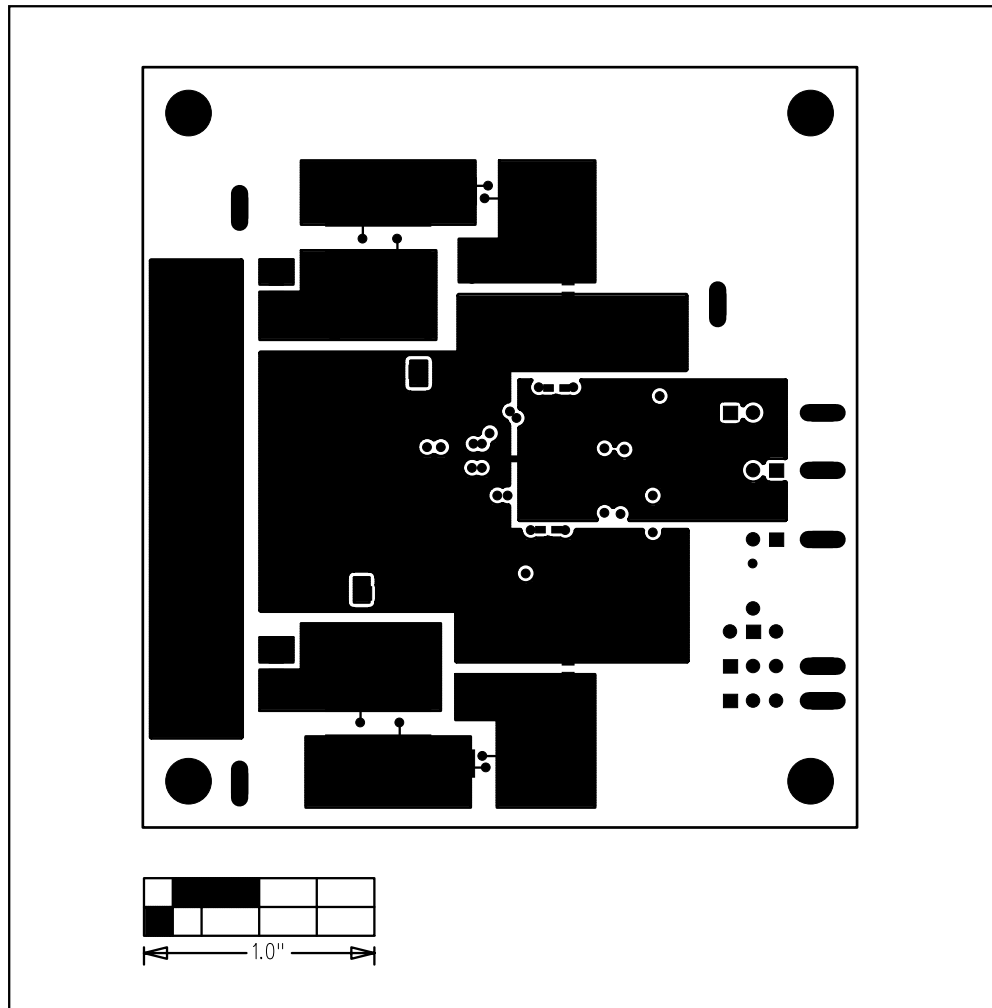

Figure 6. MAX1549 EV Kit PC Board Layout—Component Side

# MAX1549 Evaluation Kit

Evaluates: MAX1549

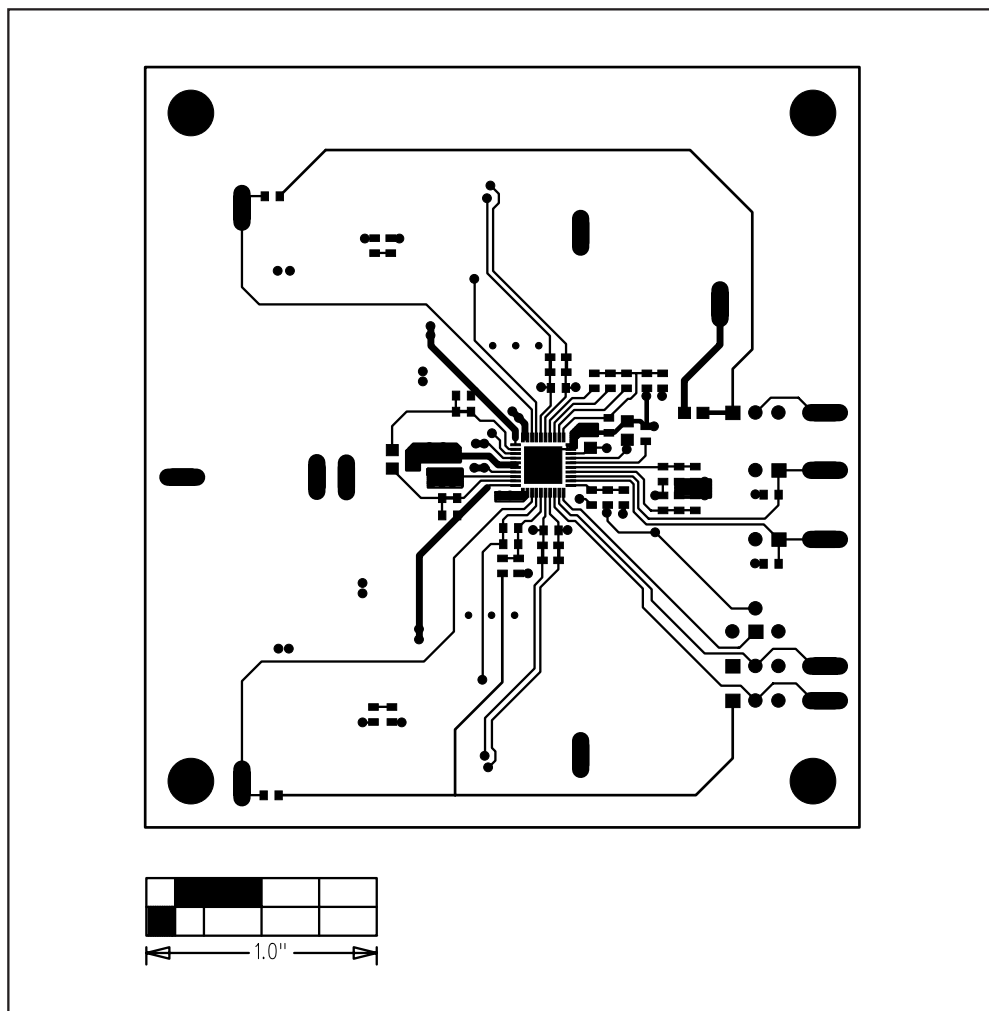

Figure 7. MAX1549 EV Kit PC Board Layout—Solder Side

## Revision History

Pages changed at Rev 1: 1, 2, 3, 11

Maxim cannot assume responsibility for use of any circuitry other than circuitry entirely embodied in a Maxim product. No circuit patent licenses are implied. Maxim reserves the right to change the circuitry and specifications without notice at any time.

Maxim Integrated Products, 120 San Gabriel Drive, Sunnyvale, CA 94086 408-737-7600 11