



MAX1215N Evaluation Kit

General Description

The MAX1215N evaluation kit (EV kit) is a fully assembled and tested printed-circuit board (PCB) that contains all the components necessary to evaluate the performance of the MAX1215N analog-to-digital converter (ADC). The EV kit features a singled-ended-to-differential conversion circuit to drive the MAX1215N inputs. The digital outputs produced by the ADC can be captured with a user-provided high-speed logic analyzer or data-acquisition system. Additionally, the EV kit includes circuitry that generates a differential clock signal from a user-provided single-ended AC signal.

Features

- ◆ Up to 250Msps Sampling Rate
- ◆ Low-Voltage and Low-Power Operation
- ◆ Fully Differential Signal Input Configuration
- ◆ On-Board Differential Output Drivers
- ◆ Fully Assembled and Tested

Ordering Information

| PART | TEMP RANGE | IC PACKAGE |
|----------------|---------------|-------------|
| MAX1215NEVKIT# | 0°C to +70°C* | 68 QFN-EP** |

#Denotes an RoHS-compliant EV kit.

*This limited temperature range applies to the EV kit PCB only. The MAX1215N IC temperature range is -40°C to +85°C.

**EP = Exposed paddle.

Component List

| DESIGNATION | QTY | DESCRIPTION |
|--|-----|--|
| C1–C9, C13, C15, C16, C18, C19, C20, C35–C39, C49, C52 | 22 | 0.1µF ±10%, 10V X5R ceramic capacitors (0402) Murata GRM155R61A104K TDK C1005X5R1A104K |
| C10, C27, C28, C40 | 4 | 220µF ±20%, 6.3V tantalum capacitors (C case) AVX TPSC227M006R0250 |
| C11, C30 | 2 | 22µF ±10%, 6.3V X5R ceramic capacitors (0805) TDK C2012X5R0J226K |
| C12 | 1 | 1pF ±0.25pF, 50V COG ceramic capacitor (0402) Murata GRM1555C1H1R0C TDK C1005C0G1H010C |
| C14, C33 | 2 | 2.2µF ±10%, 6.3V X5R ceramic capacitors (0603) Taiyo Yuden JMK107BJ225KA TDK C1608X5R0J225K |
| C21–C24 | 4 | 0.22µF ±10%, 6.3V X5R ceramic capacitors (0402) Taiyo Yuden JMK105BJ224KV TDK C1005X5R0J224K |
| C25, C26, C51, C53, C54, C55 | 6 | 0.1µF ±10%, 50V X7R ceramic capacitors (0603) Murata GRM188R71H104K TDK C1608X7R1H104K |

| DESIGNATION | QTY | DESCRIPTION |
|-------------|-----|---|
| C29, C41 | 2 | 10µF ±20%, 6.3V X5R ceramic capacitors (0805) Murata GRM21BR60J106K TDK C2012X5R0J106M |
| C31, C43 | 0 | Not installed, ceramic capacitors (0805) |
| C32, C42 | 2 | 1.0µF ±10%, 10V X5R ceramic capacitors (0603) Murata GRM188R61A105K TDK C1608X5R1A105K |
| C34, C44 | 0 | Not installed, ceramic capacitors (0603) |
| C45–C48 | 0 | Not installed, tantalum capacitors (C case) |
| C50, C56 | 2 | 0.01µF ±10%, 50V X7R ceramic capacitors (0603) Murata GRM188R71H103K TDK C1608X7R1H103K |
| C58–C71 | 0 | Not installed, ceramic capacitors (0402) |
| CLK, IN | 2 | SMA PCB vertical-mount connectors |
| J1 | 1 | 2 x 4-pin male header, 2.54mm |
| J2–J5 | 4 | 2 x 20-pin male headers, 2.54mm |

Evaluates: MAX1215N



MAX1215N Evaluation Kit

Component List (continued)

| DESIGNATION | QTY | DESCRIPTION |
|---|-----|--|
| JU1, JU2, JU3, JU5 | 4 | 3-pin headers |
| JU4 | 0 | Not installed, 2-pin header |
| JU6 | 0 | Not installed, 3-pin header |
| R1, R11, R13 | 0 | Not installed, resistors (0603) |
| R2, R4–R7, R10, R12, R14, R15, R38, R39, R41, R43–R79 | 49 | 49.9 Ω \pm 1% resistors (0402) |
| R3, R82 | 2 | 0 Ω resistors (0603) |
| R8, R9 | 2 | 24.9 Ω \pm 0.1% resistors (0603) IRC PFC-W0603RLF-02-24R9-B |
| R16, R17 | 2 | 10 Ω \pm 1% resistors (0603) |
| R18–R24, R28–R32, R34, R35 | 14 | 100 Ω \pm 1% resistors (0603) |
| R25, R37 | 2 | 510 Ω \pm 5% resistors (0603) |
| R26 | 1 | 10k Ω \pm 1% resistor (0603) |
| R27 | 1 | 5k Ω potentiometer, 19-turn, 3/8in Vishay T93YB-5K-10-D06 or Mouser 72-T93YB-5K |
| R33 | 1 | 3.16k Ω \pm 1% resistor (0603) |
| R36 | 1 | 1.82k Ω \pm 1% resistor (0603) |
| R40 | 1 | 100k Ω potentiometer, 12-turn, 1/4in Bourns 3266W-1-104 or Mouser 652-3266W-1-104 |
| R42 | 1 | 13k Ω \pm 1% resistor (0603) |

| DESIGNATION | QTY | DESCRIPTION |
|-------------|-----|--|
| R80 | 0 | Not installed, resistor—shorted by PC trace (0603) |
| R81 | 1 | 0 Ω resistor (0402) |
| T1 | 1 | 1:1 800MHz RF transformer Mini-Circuits ADT1-1WT+ |
| T2 | 1 | 1:1 250MHz RF transformer Coilcraft TTWB2010-1LB |
| TP1 | 1 | Red test point |
| U1 | 1 | MAX1215NEGK+D (68-pin QFN-EP, 10mm x 10mm) |
| U2 | 1 | MAX9388EUP+ differential 4:1 multiplexer (20-pin TSSOP) |
| U3–U6 | 4 | 3.3V ECL quad differential receivers (20-pin SO) On Semiconductor MC100LVEL17DWG Digi-Key MC100LVEL17DWGOS-NG |
| Y1 | 0 | Not installed, clock oscillator (9mm x 14mm) |
| — | 5 | Shunts |
| — | 1 | PCB: MAX1215N Evaluation Kit# |

Component Suppliers

| SUPPLIER | PHONE | WEBSITE |
|-----------|--------------|-----------------------|
| AVX Corp. | 843-946-0238 | www.avxcorp.com |
| IRC | 361-992-7900 | www.irctt.com |
| TDK Corp. | 847-803-6100 | www.component.tdk.com |

Note: Indicate that you are using the MAX1215N when contacting these component suppliers.

Quick Start

Recommended Equipment

Before beginning, the following equipment is needed:

- DC power supplies:

| | | |
|---------|---------|-------------|
| Analog | (VCC) | 1.8V, 1A |
| Digital | (OVCC) | 1.8V, 200mA |
| Clock | (VCLK) | 3.3V, 200mA |
| Buffers | (VPECL) | 3.3V, 400mA |
- One signal generator with low-phase noise and low jitter for clock input (e.g., HP/Agilent 8644B); bandpass filtering is strongly recommended (e.g., Allen Avionics, K&L Microwave)
- One signal generator for analog signal input (e.g., HP/Agilent 8644B); bandpass filtering is strongly recommended (e.g., Allen Avionics, K&L Microwave)
- Logic analyzer or data-acquisition system (e.g., HP/Agilent 16500C with high-speed state card HP/Agilent 16517A)
- Digital voltmeter

MAX1215N Evaluation Kit

Procedure

The MAX1215N EV kit is a fully assembled and tested surface-mount board. Follow the steps below for board operation. **Caution: Do not turn on power supplies or enable signal generators until all connections are completed.**

- 1) Verify that shunts are installed in the following locations:
 - JU1 (2-3) → U2 selects CLK
 - JU2 (1-2) → divide-by-two disabled
 - JU3 (2-3) → two's-complement output selected
 - J1 (3-4) → internal reference enabled
 - JU5 (2-3) → clock signal (CLK) duty cycle set to 50%
- 2) Connect the filtered clock signal generator to the SMA connector labeled CLK.
- 3) Connect the filtered analog input signal generator to the SMA connector labeled IN.
- 4) Connect the logic analyzer with a high-speed probe to either headers J2/J3 (LVDS-compatible signals) or J4/J5 (LVPECL-compatible signals). See Table 4 for header connections.
- 5) Connect a 1.8V, 1A power supply to VCC. Connect the ground terminal of this supply to GND closest to the VCC pad.
- 6) Connect a 1.8V, 200mA power supply to OVCC. Connect the ground terminal of this supply to GND closest to the OVCC pad.
- 7) Connect a 3.3V, 200mA power supply to VCLK. Connect the ground terminal of this supply to GND closest to the VCLK pad.
- 8) Connect a 3.3V, 400mA power supply to VPECL. Connect the ground terminal of this supply to GND closest to the VPECL pad.
- 9) Turn on all power supplies.
- 10) Enable the signal generators. Set the clock signal generator to output a 250MHz signal with an amplitude of 2.4V_{P-P}. Set the analog input signal generator to output the desired frequency with an amplitude $\leq 2V_{P-P}$. For coherent sampling, the signal generators should be synchronized.
- 11) Enable the logic analyzer.
- 12) Capture data using the logic analyzer.

Detailed Description

The MAX1215N EV kit is a fully assembled and tested PCB that contains all the components necessary to evaluate the performance of the MAX1215N, 12-bit LVDS output ADC. The MAX1215N can be evaluated with a maximum clock frequency (f_{CLK}) of 250MHz.

The MAX1215N converter accepts differential inputs. Applications that only have a single-ended signal source available can use the on-board transformers (T1 and T2) to convert the single-ended signal to a differential signal.

Differential receivers (U3–U6) buffer and convert the LVDS output signals of the MAX1215N to higher voltage LVPECL signals that can be captured by a wide variety of logic analyzers. The LVDS outputs are accessed at headers J2 and J3. The LVPECL outputs are accessed at headers J4 and J5.

The EV kit is designed as a four-layer PCB to optimize the PCB layout. Separate analog, digital, clock, and buffer power planes minimize noise coupling between analog and digital signals; 50 Ω microstrip transmission lines are used for analog and clock inputs and 100 Ω differential microstrip transmission lines are used for all digital LVDS outputs. All LVDS differential outputs are terminated with 100 Ω termination resistors between true and complementary digital outputs. The trace lengths of the 100 Ω differential LVDS lines are matched to within a few thousandths of an inch to minimize layout-dependent delays. All LVPECL differential outputs are Y-terminated with 49.9 Ω resistors on each branch.

Power Supplies

The MAX1215N EV kit requires separate analog, digital output, clock, and buffer power supplies for best performance. Two 1.8V power supplies are used to power the analog and digital portions of the MAX1215N. The on-board clock circuitry is powered by a 3.3V power supply. A separate 3.3V power supply is used to power the output buffers (U3–U6) on the EV kit.

Clock

The MAX1215N requires a differential clock signal. However, only a single-ended clock signal source is required. The EV kit's on-board circuitry converts a single-ended clock signal to the required differential signal. The frequency of the sinusoidal input clock signal determines the sampling frequency (f_{CLK}) of the ADC. A differential multiplexer (U2) processes the input signal to generate the required clock signal. The input signal should not exceed an amplitude of 2.6V_{P-P}. The frequency of the clock signal should not exceed 250MHz.

MAX1215N Evaluation Kit

The output clock duty cycle at U2 can be set to a fixed 50% duty cycle or can be adjusted whenever a single-ended signal is applied to the CLK SMA connector. Configure jumper JU5 to set the signal's duty cycle to 50% or to adjust the duty cycle with potentiometer R27. See Table 1 for configuring jumper JU5.

Table 1. Clock Duty Cycle (JU5)

| SHUNT POSITION | U2 $\overline{D0}$ PIN | FUNCTION |
|----------------|--------------------------------|---|
| 1-2 | Connected to potentiometer R27 | Clock duty cycle is adjustable with R27 |
| 2-3* | Connected to VBB2 | Clock duty cycle is set to 50% |

*Default position.

The MAX1215N EV kit also provides circuitry so the user can install a crystal oscillator (Y1, Valpey Fisher VF561E series recommended) to generate an on-board differential clock source. The differential line receiver and multiplexer IC (U2) can be configured to select between the SMA CLK signal and the crystal oscillator Y1 output signal by using jumper JU1. See Table 2 for configuring jumper JU1. **Note:** The crystal oscillator's duty cycle cannot be adjusted with jumper JU5.

Table 2. Selecting Clock Source (JU1)

| SHUNT POSITION | U2 SEL0 PIN | CLOCK SOURCE SELECTION |
|----------------|-------------------|-------------------------------|
| 1-2 | Connected to VCLK | Selects crystal oscillator Y1 |
| 2-3* | Connected to GND | Selects SMA CLK input |

*Default position.

Clock Divider

The MAX1215N features an internal divide-by-two clock divider. Use jumper JU2 to enable/disable this feature. See Table 3 for shunt positions.

Table 3. Clock-Divider Shunt Settings (JU2)

| SHUNT POSITION | MAX1215N CLKDIV PIN | DESCRIPTION |
|----------------|---------------------|---------------------------|
| 1-2* | Connected to VCC | Clock signal divided by 1 |
| 2-3 | Connected to GND | Clock signal divided by 2 |

*Default position.

Input Signal

The MAX1215N accepts differential analog input signals. However, the EV kit only requires a 50 Ω terminated single-ended analog input signal with an amplitude of less than 2V_{P-P} provided by the user. The on-board transformers (T1 and T2) convert the single-ended analog input into a differential analog signal, which is applied to the ADC's differential input pins.

Optional Input Transformer

The MAX1215N EV kit uses two transformers to enhance the THD and the SFDR performance at high input frequencies (> 100MHz). These two transformers help reduce the increase of even-order harmonics at high frequencies. To use only one transformer, follow the directions below:

- 1) Remove transformer T1.
- 2) Install 0 Ω resistors (0603) on R11 and R13.

Reference Voltage

There are two methods to set the full-scale range (FSR) of the MAX1215N. The MAX1215N EV kit can be configured to use the ADC's internal reference, or a stable, low-noise, external reference can be applied to the REFIO pad. Jumper J1 controls which reference source is used. See Table 4 for shunt settings.

Table 4. Reference Shunt Settings (J1)

| SHUNT POSITION | DESCRIPTION |
|----------------|---|
| 1-2 | Internal reference disabled. Apply an external reference voltage to the REFIO pad |
| 3-4* | Internal reference enabled |
| 5-6 | Increases FSR through potentiometer R40 |
| 7-8 | Decreases FSR through potentiometer R40 |

*Default position.

Output Signal

The MAX1215N features a single 12-bit, parallel, LVDS-compatible, digital output bus. The digital outputs also feature a clock bit (DCLKP/N) for data synchronization, and a data overrange bit (ORP/N). See Table 6 for header connections.

MAX1215N Evaluation Kit

Output Format

The digital output coding can be chosen to be either in two's-complement or straight offset binary format by configuring jumper JU3. See Table 5 for shunt settings.

Output Bit Locations

The digital outputs of the ADC are connected to two 40-pin headers (J2 and J3). PCB trace lengths are matched to minimize output skew and improve performance of the device. In addition, four differential receivers (U3–U6) buffer and level translate the ADC's digital outputs to LVPECL-compatible signals. The differential receivers increase the differential voltage swing and are able to drive large capacitive loads, which may be present at the logic analyzer connection. The outputs of the buffers are connected to two 40-pin headers (J4 and J5). See Table 6 for headers J4 and J5 bit locations.

Table 5. Output-Format Shunt Settings (JU3)

| SHUNT POSITION | MAX1215N \bar{T}/B PIN | DESCRIPTION |
|----------------|--------------------------|--|
| 1-2 | Connected to VCC | Digital output in straight offset binary |
| 2-3* | Connected to GND | Digital output in two's complement |

*Default position.

Table 6. Output Bit Locations

| BIT | | UNBUFFERED (LVDS) | BUFFERED (LVPECL) | BIT | | DESCRIPTION |
|------|---|-------------------|-------------------|-----|------|---------------------|
| D11 | P | J2-10 | J4-10 | P | LD11 | MSB |
| | N | J2-9 | J4-9 | N | | |
| D10 | P | J2-16 | J4-16 | P | LD10 | Data bits |
| | N | J2-15 | J4-15 | N | | |
| D9 | P | J2-22 | J4-22 | P | LD9 | |
| | N | J2-21 | J4-21 | N | | |
| D8 | P | J2-28 | J4-28 | P | LD8 | |
| | N | J2-27 | J4-27 | N | | |
| D7 | P | J2-34 | J4-34 | P | LD7 | |
| | N | J2-33 | J4-33 | N | | |
| D6 | P | J2-40 | J4-40 | P | LD6 | |
| | N | J2-39 | J4-39 | N | | |
| D5 | P | J3-8 | J5-8 | P | LD5 | |
| | N | J3-7 | J5-7 | N | | |
| D4 | P | J3-14 | J5-14 | P | LD4 | |
| | N | J3-13 | J5-13 | N | | |
| D3 | P | J3-20 | J5-20 | P | LD3 | |
| | N | J3-19 | J5-19 | N | | |
| D2 | P | J3-26 | J5-26 | P | LD2 | |
| | N | J3-25 | J5-25 | N | | |
| D1 | P | J3-32 | J5-32 | P | LD1 | |
| | N | J3-31 | J5-31 | N | | |
| D0 | P | J3-38 | J5-38 | P | LD0 | LSB |
| | N | J3-37 | J5-37 | N | | |
| OR | P | J2-4 | J4-4 | P | LOR | Overrange bit |
| | N | J2-3 | J4-3 | N | | |
| DCLK | P | J3-2 | J5-2 | P | LDC0 | Clock output signal |
| | N | J3-1 | J5-1 | N | | |

MAX1215N Evaluation Kit

Evaluates: MAX1215N

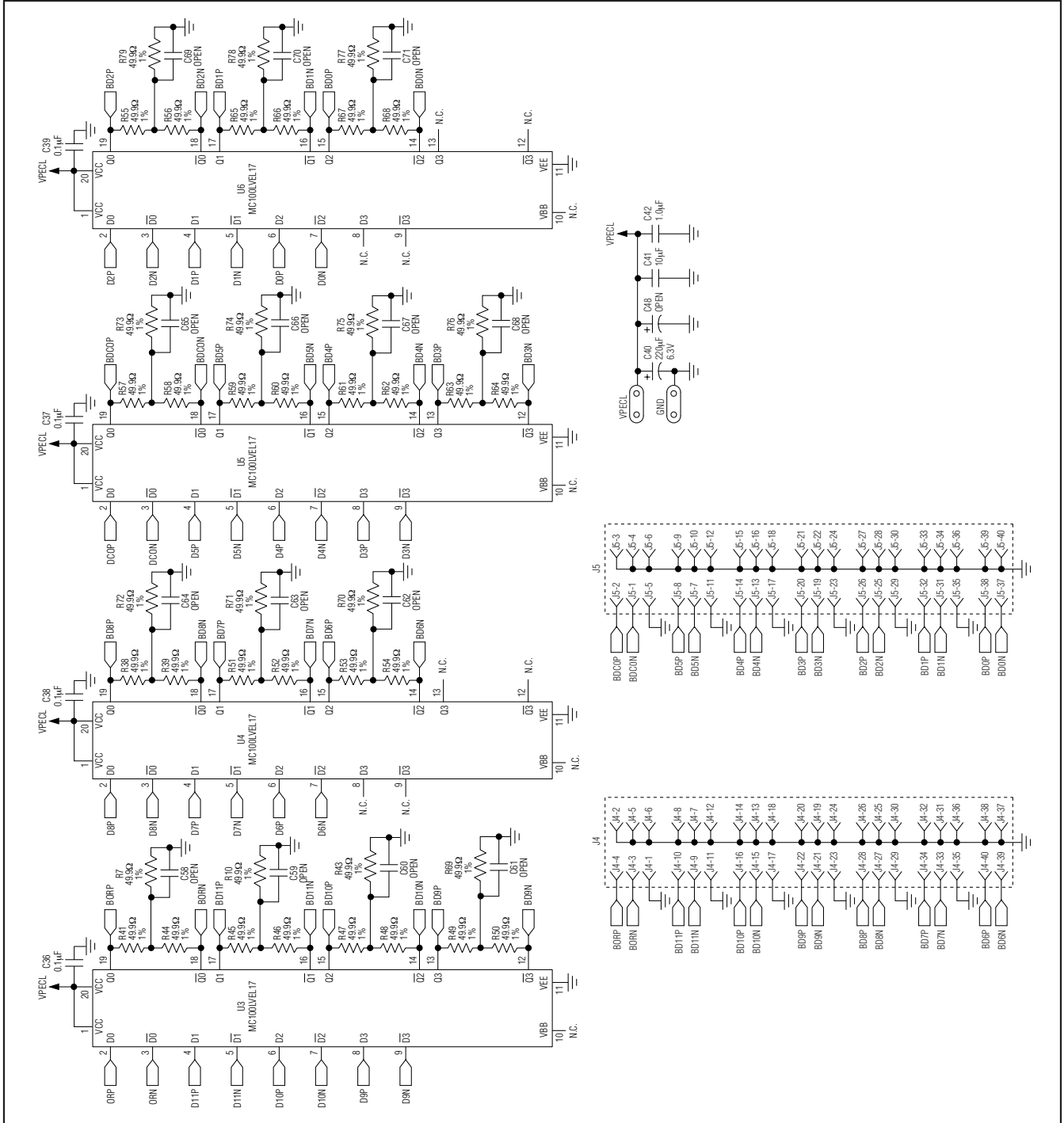

Figure 1b. MAX1215N EV Kit Schematic (Sheet 2 of 3)

MAX1215N Evaluation Kit

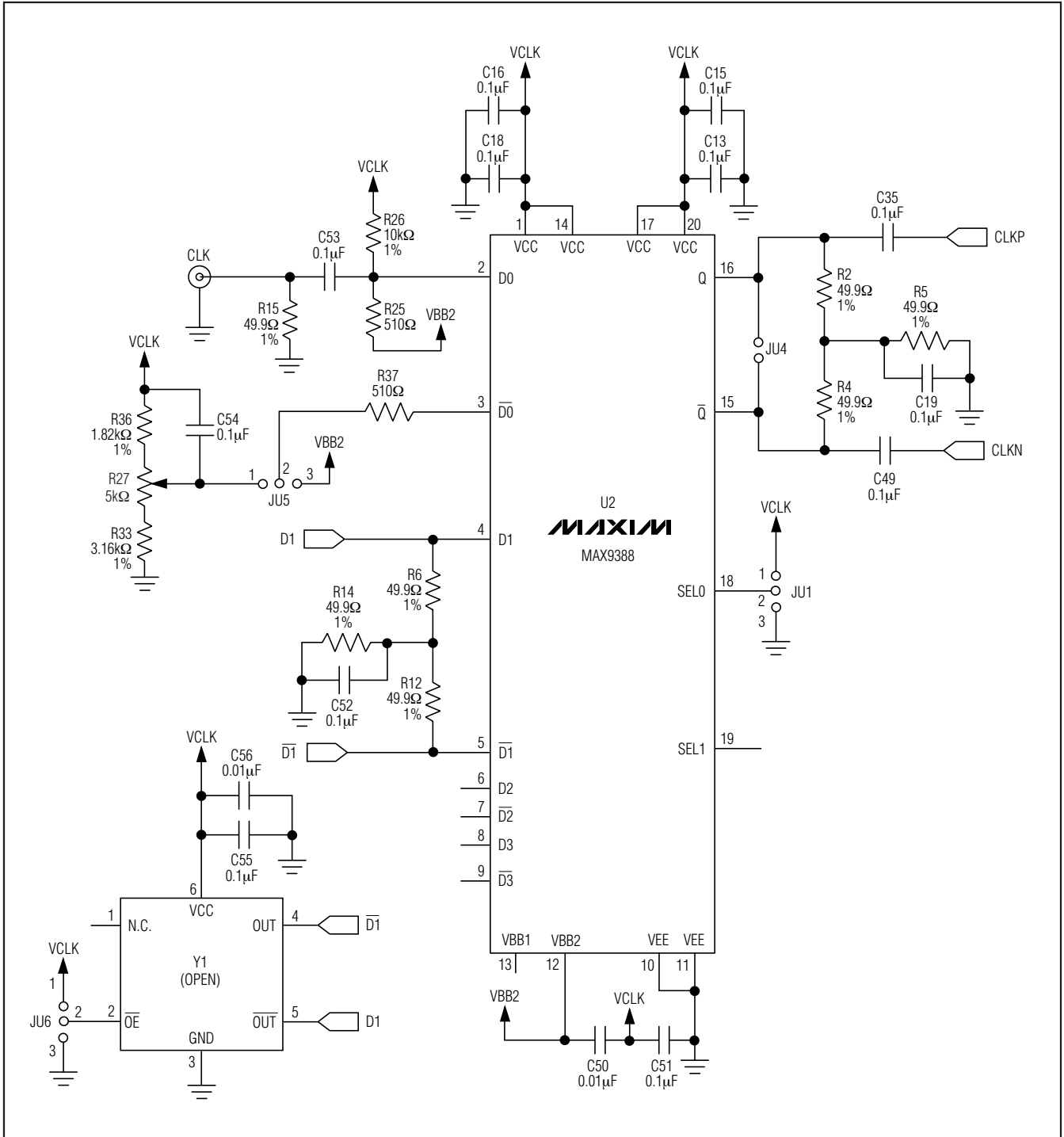

Figure 1c. MAX1215N EV Kit Schematic (Sheet 3 of 3)

MAX1215N Evaluation Kit

Evaluates: MAX1215N

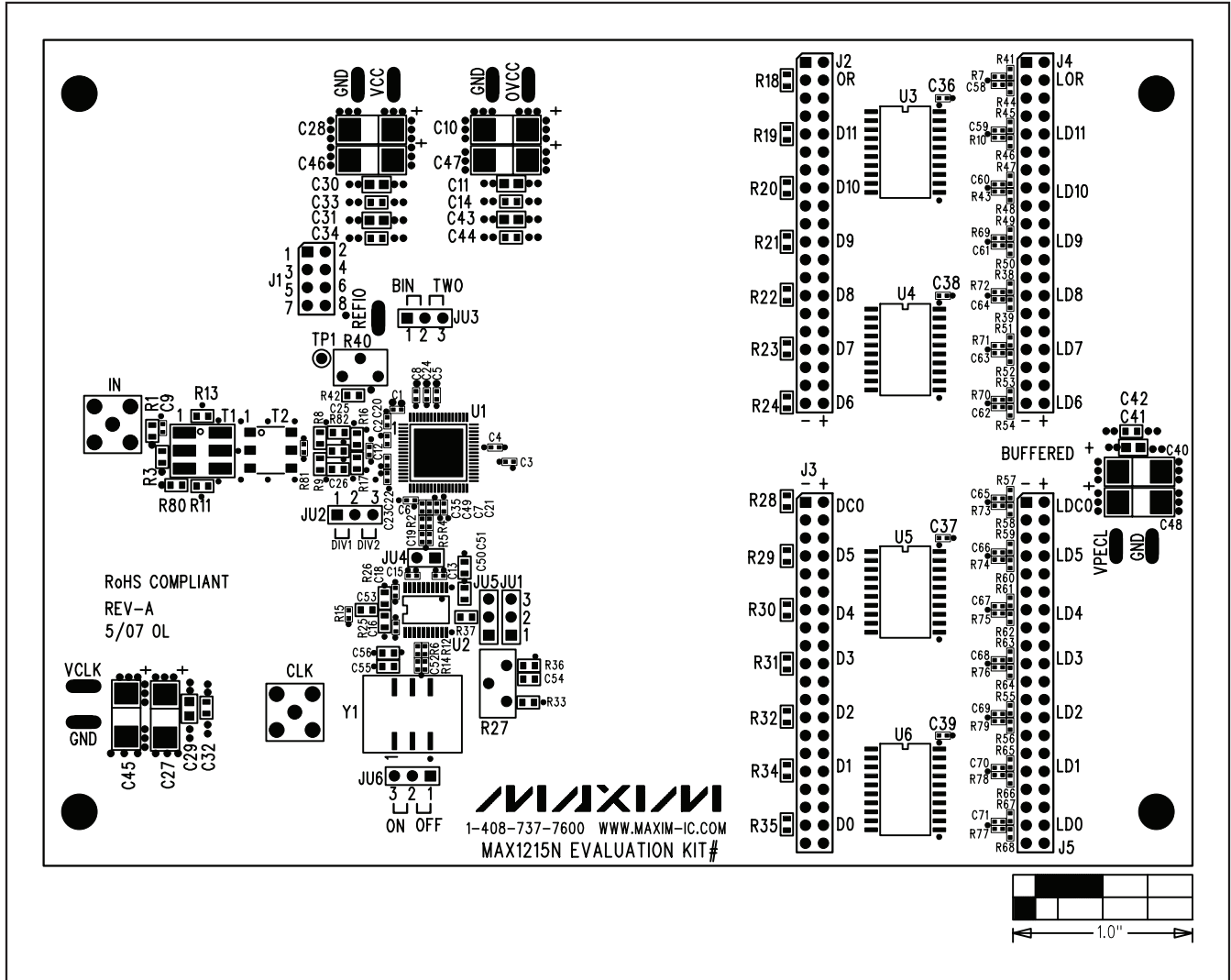

Figure 2. MAX1215N EV Kit Component Placement Guide—Component Side

MAX1215N Evaluation Kit

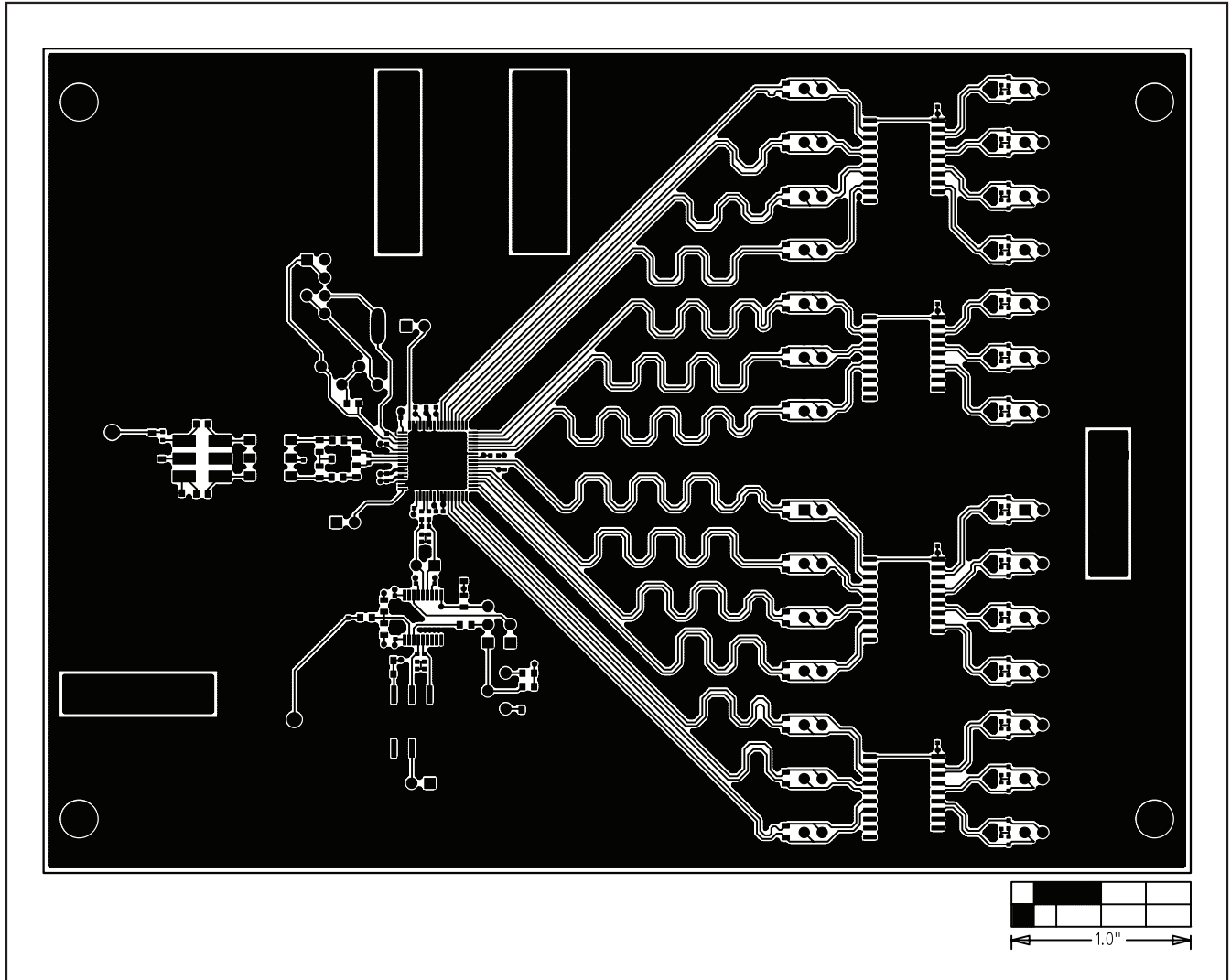

Figure 3. MAX1215N EV Kit PCB—Component Side

MAX1215N Evaluation Kit

Evaluates: **MAX1215N**

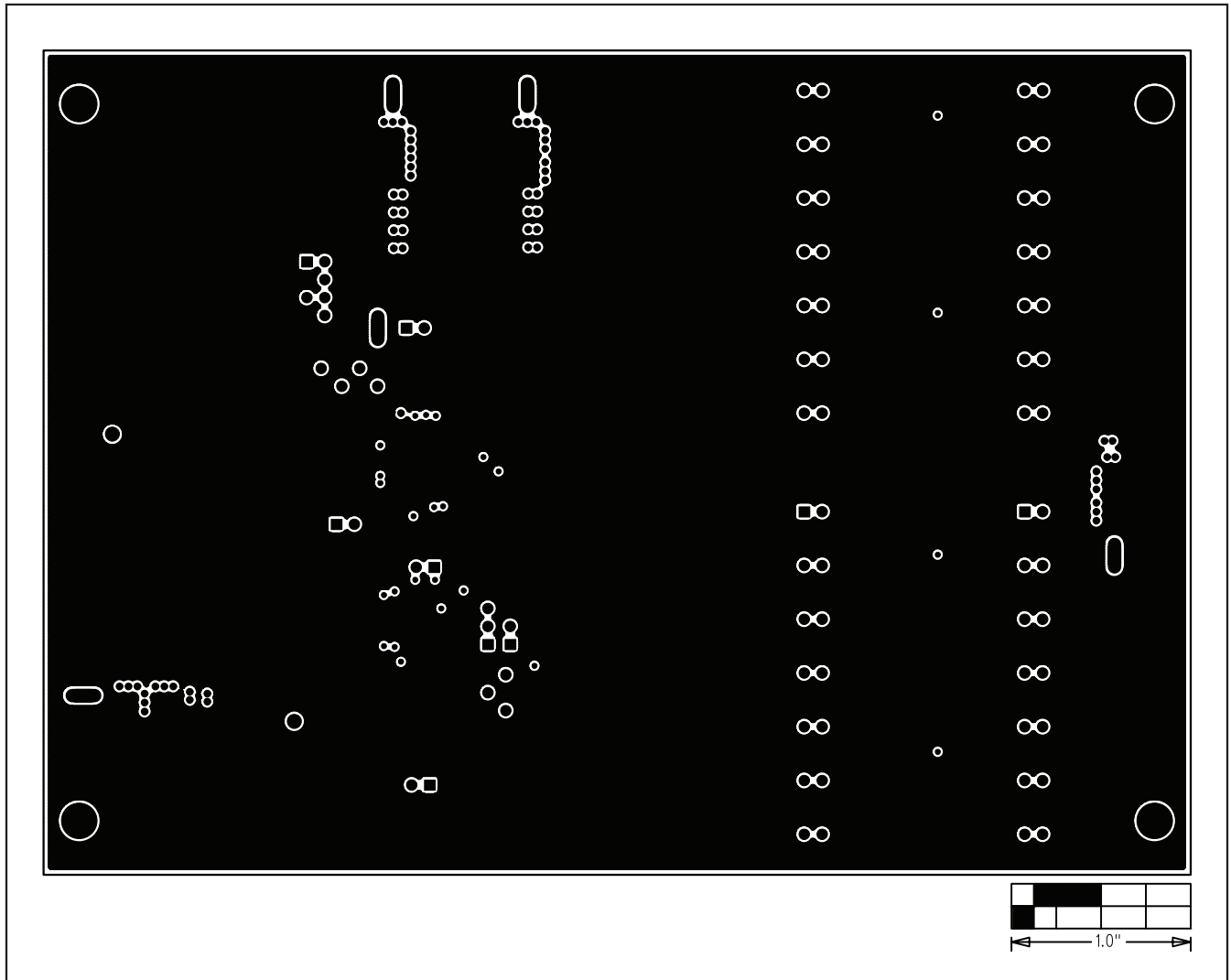

Figure 4. MAX1215N EV Kit PCB Layout—Ground Plane (Layer 2)

MAX1215N Evaluation Kit

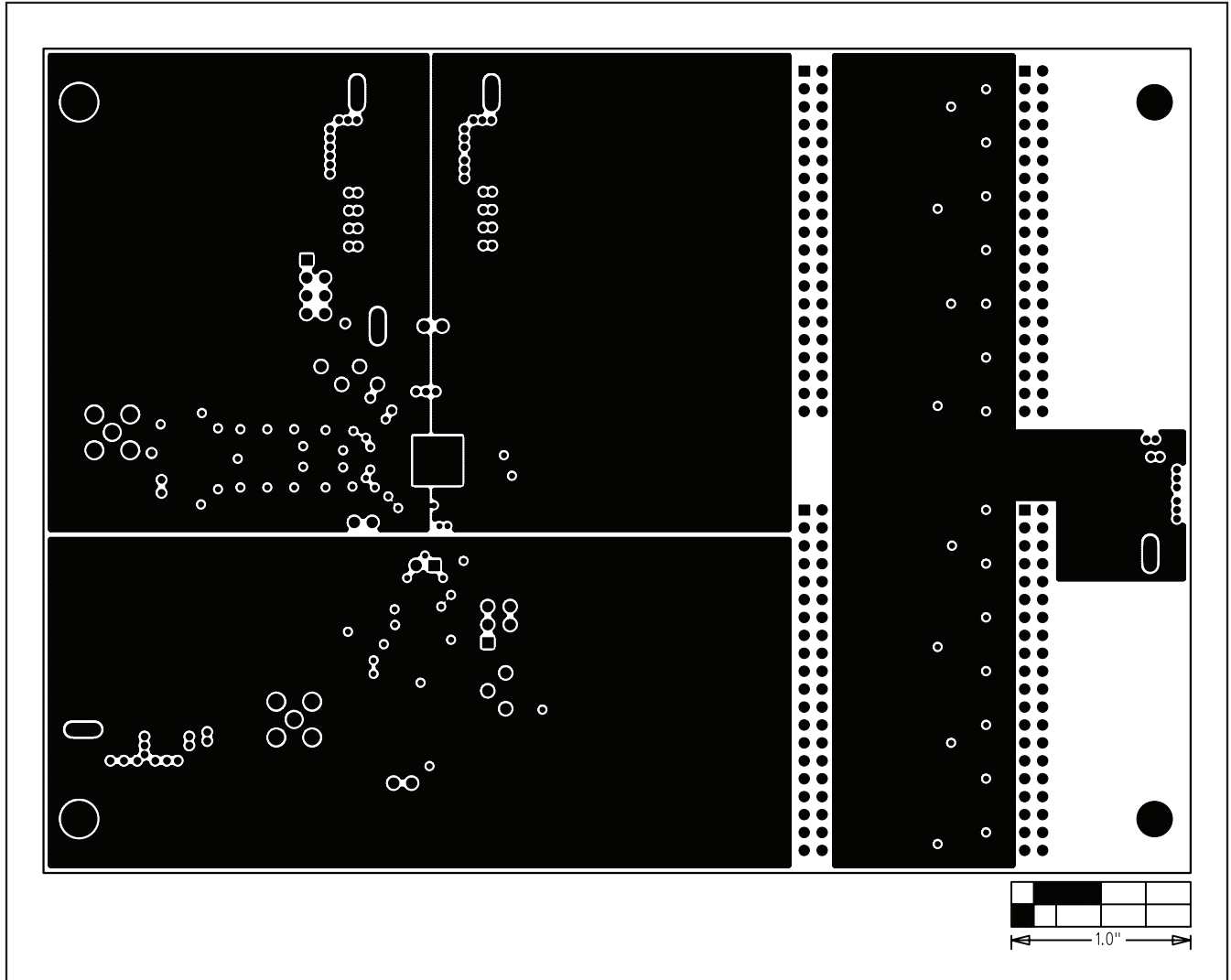

Figure 5. MAX1215N EV Kit PCB Layout—Power Plane (Layer 3)

MAX1215N Evaluation Kits

Evaluates: **MAX1215N**

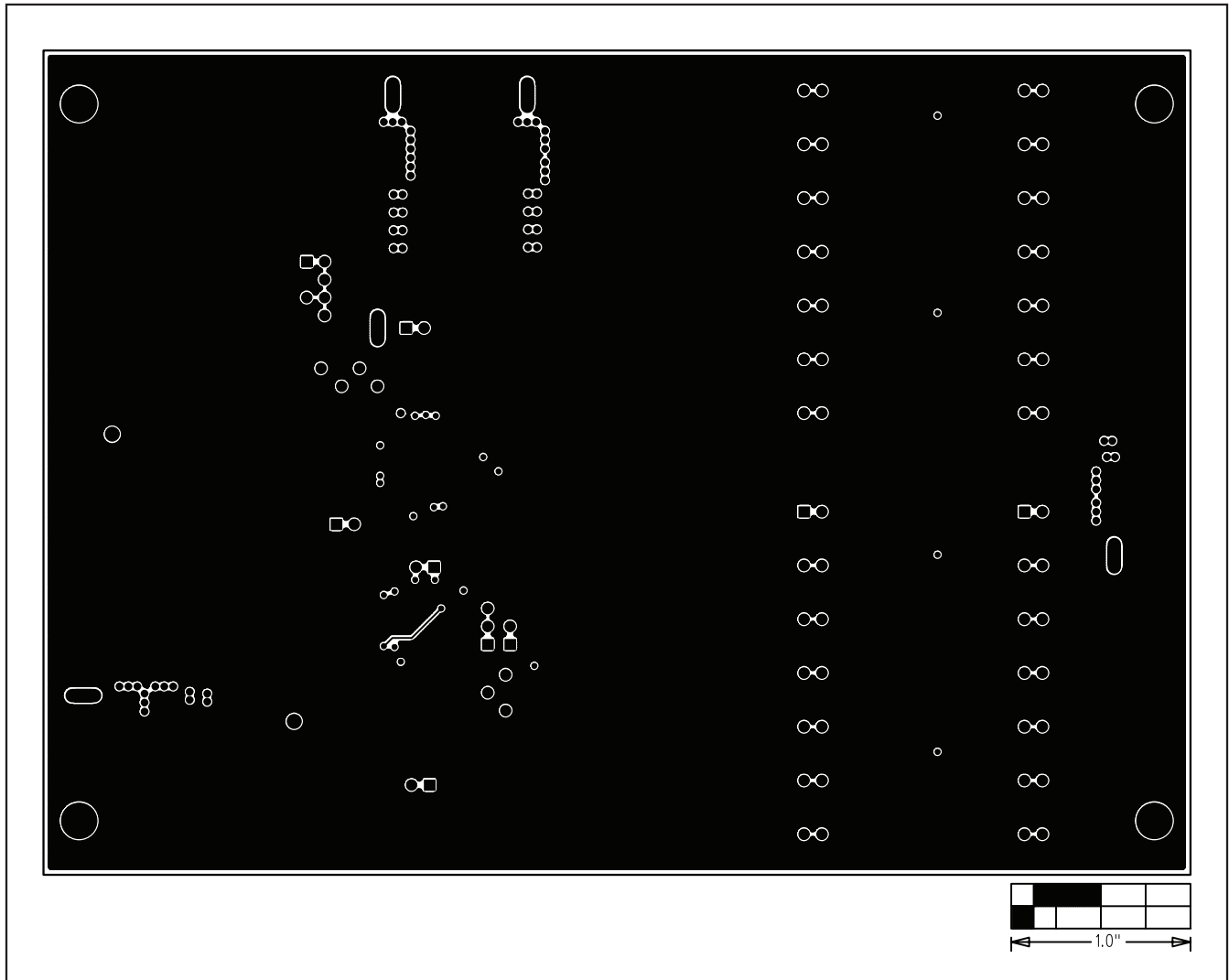

Figure 6. MAX1215N EV Kit PCB Layout—Solder Side

Maxim cannot assume responsibility for use of any circuitry other than circuitry entirely embodied in a Maxim product. No circuit patent licenses are implied. Maxim reserves the right to change the circuitry and specifications without notice at any time.

Maxim Integrated Products, 120 San Gabriel Drive, Sunnyvale, CA 94086 408-737-7600 _____ 13